

P2

Panasonic®

Operating Instructions

Water Purifier For Household Use

使用說明書

濾水器 家庭用

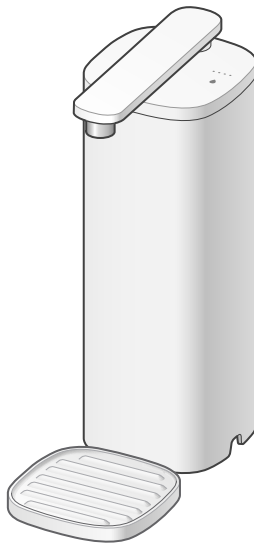

MicroClear

Model No. TK-CS600

Thank you for purchasing this Panasonic product.

- Please read these instructions carefully before using this product, and save this manual for future use.
- Please carefully read the “Safety Precautions” (P. EN3-EN4) of this manual before use.
- Be sure to check that the purchase date has been entered on the warranty.
- Please keep in mind that the manufacturer of the product will not be responsible for any product malfunctioning or accidents resulting from the improper installation or operation of the product.

感謝您購買Panasonic的產品。

- 請在使用本產品之前仔細閱讀本說明書，並妥善保管本說明書以備日後使用。
- 請在使用之前仔細閱讀「安全注意事項」（參閱TC3～TC4頁）。
- 保證書上的「購買日期」請務必填寫。
- 因安裝錯誤或不正確使用，而造成產品故障或發生事故時，本公司恕不負責。

English

繁體中文

The Water Purifier

- Delivers safe water without the need of boiling.
- Creates enough amount of clean water so that you can also use it for cooking and dish washing.

- Free residual chlorine
- Turbidity
- Chloroform
- Total trihalomethane
- Bromodichloromethane
- Dibromochloromethane
- Bromoform
- Tetrachloroethylene
- Trichloroethylene
- CAT (pesticide)
- 2-MIB (mold smell)
- Soluble lead
- 1,2-DCE
- Benzene
- Geosmin (mold smell)
- Phenols
- PFOS and PFOA
- Iron (particulate form)
- Aluminum (neutral)

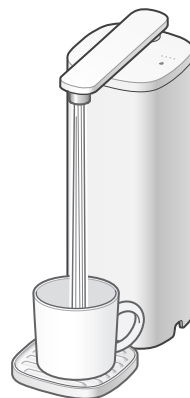

Contents

Safety Precautions	EN3
Operating Precautions	EN5

Installation 1

Check the main unit and supplied accessories	EN6
--	-----

Installation 2

Inserting of the batteries into the main unit	EN7
---	-----

Installation 3

Check the shape of faucet	EN9
---------------------------------	-----

Installation 4

Attach the bypass selector	EN10
----------------------------------	------

Installation 5

Install the Water Purifier	EN13
----------------------------------	------

Installation 6

Check after installation	EN14
--------------------------------	------

How to Use	EN15
Maintenance	EN16
Replacing the Cartridge	EN18
When the Water Supply is Cut Off	EN21
When Not in Use for Long Periods	EN21
When Moving the Water Purifier	EN22
Q&A	EN23
Before Requesting a Repair Service	EN24
Optional Accessories	EN25
Specifications	EN26

Safety Precautions

Please make sure to follow these instructions

In order to prevent any harm to human body or damage to property, always follow the instructions below.

■ The following classifies the degree of risks of harm and damage caused by incorrect use of the product.



WARNING

Indicates risk of serious injury or death.



CAUTION

Indicates risk of injury or property damage.

■ Precautinary symbols are classified as shown below. (The following are examples of symbols.)



This symbol indicates prohibition.



This symbol indicates requirements to be observed.



WARNING

Water supply



- Do not use water sources other than qualified drinking water. (Doing so may cause health problems.)
- The Water Purifier cannot sterilize water or remove harmful substances (P. EN2).



CAUTION

About batteries



- Do not dispose of batteries in fires, or short circuit or disassemble them. (Doing so may cause burns or injury.)
- Do not use rechargeable battery instead of dry battery. (Failure to do so may cause injury or surrounding contamination due to heat generation, bursting, or leakage of the alkaline batteries.)



- Always adhere to the precautions shown on the battery.
- Check the ⊕ and ⊖ of the battery, and insert them correctly.
- Use the specified batteries only.
- Do not mix batteries from different manufacturers or brands.
- Do not mix new and old alkaline batteries or different types of alkaline batteries.
- Remove the alkaline batteries when not using the appliance for an extended period of time.
- Non-rechargeable batteries are not to be recharged.
- Remove the alkaline batteries immediately and dispose of them safely when they are discharged.
- Use batteries that are within the specification's recommended expiry date. (Failure to do so may cause injury or surrounding contamination due to heat generation, bursting, or leakage of the alkaline batteries.)

Safety Precautions Please make sure to follow these instructions (continued)

CAUTION

Installation location



- **Do not block the main spout, or bend, twist, flatten, pull or clamp the hose.**
(Doing so may cause water to leak, interrupt the output of water or cause other problems.)
- **Do not connect a hose or any other appliances to main spout.**
(Doing so may cause water leaks or malfunctions.)

Storing purified water



- **Use purified water immediately after it is produced. When storing it for future consumption, pour it into a clean sealed container, and consume it within 1 day if it is kept at room temperature or within 2 days if it is kept in the refrigerator.**
(Since the Water Purifier removes sterilizers (such as chlorine), the water quality is altered over time, possibly causing health problems.)

When using purified water



- **Do not use purified water for the care of fish, etc.**
(The fish, etc. may die due to the change in the environment.)



- **At the beginning of daily use, run water approx. 0.6 liters (approx. 18 seconds) before using.**
- **If 2 days or more have passed after the last use, run water approx. 8 liters (approx. 4 minutes) before using.**
(Using residual water inside the main unit may cause ill health.)

About users of the product



- **This appliance is not intended for use by persons (including children) with reduced physical, sensory or mental capabilities, or lack of experience and knowledge, unless they have been given supervision or instruction concerning use of the appliance by a person responsible for their safety. Children should be supervised to ensure that they do not play with the appliance. Keep this instruction manual in a safe place.**
(Otherwise an accident or health problems may result.)

Disassembly prohibited



- **Do not disassemble, repair or remodel the unit.**
(Doing so may cause of water leakage or malfunction.)
→ Please contact a dealer for inspection or maintenance.

Accidental ingestion



- **Do not leave the supplied accessories within reach of infants or toddlers.**
(Doing so may cause accidental swallowing of accessories.)
 - Consult a doctor immediately if you suspect that an accessory has been swallowed.
- **Do not allow infants or toddlers to play with packaging material.**
(Doing so may cause suffocation.)

Operating Precautions

Water supply

- **Do not drink water in case of the following conditions.**
 - Very turbid water, or water containing a great deal of red rust
(Doing so may shorten the service life of the cartridge.)



Installation

- **Do not install the Water Purifier in the following locations.**
 - **Near hot areas such as heating appliances (60 °C or above)**
(The product may become deformed.)
 - **Where the product is exposed to direct sunlight, or wind and rain**
(An operational error or malfunction may occur.)
 - **Where freezing may occur (operating environment temperature range: 5 °C or more)**
(Cracking in the water pipes or cartridge may occur.)
 - **Where the product tends to be subject to oil**
(The main unit may be cracked.)
 - **In a bathroom or where the product is exposed to water or steam**
(An operational error or malfunction may occur.)
- **Do not connect the Water Purifier to a hot water-dedicated faucet.**
(Doing so may cause malfunction.)
- **Do not extend the main spout using a commercially sold hose, etc.**
(Doing so may cause malfunction.)
- **Do not place the unit in an unstable location.**
(Doing so may cause malfunction.)
- **Do not lift the main unit by taking hold of the outlet pipe.**
(Doing so damage may result.)

Usage

- **Do not lay down the main unit for use.**
(Doing so may cause malfunction.)
- **Use water with the temperatures shown in the table below.**
(Failure to do so may cause damage, or cause trihalomethane adsorbed by the cartridge to be partially discharged.)

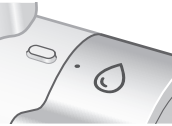

Position of bypass selector	Water temperature
When using purified water •  : Purified 	Under 35 °C
When using tap water •  : Unpurified 	Under 80 °C

Installation 1 Check the main unit and supplied accessories

Overall figure

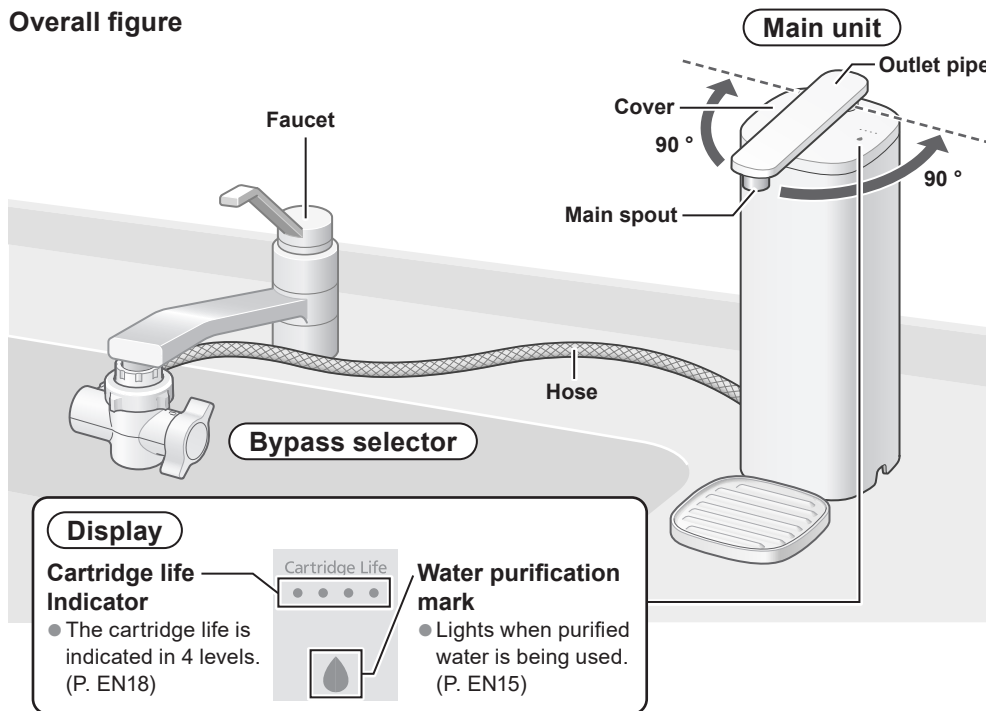

Items in the package

If any are missing, contact your dealer.

■ Main unit

Cartridge
(Consumables)
(P. EN18-EN20)

Hose
(length: approx. 80 cm)

■ Tray



■ Bypass selector

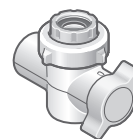

Supplied Accessories

■ **Installation Adaptor**
(with 4 screws)



■ **Bushing**
(with gasket)



Batteries are not supplied. Please purchase them from your dealer.

Installation 2 Inserting of the batteries into the main unit

- Prepare 2 LR6 (AA Alkaline battery).
- Alkaline batteries are not supplied. Please buy them separately.
- Use of batteries not specified will significantly shorten the usage time.
- Panasonic batteries are recommended.

1 Remove the cover.

- 1 Turn the cover until it comes in contact with the stopper.
 - 2 Raise the cover.
- Do not hold the outlet pipe to turn the cover. (Doing so may cause malfunction.)

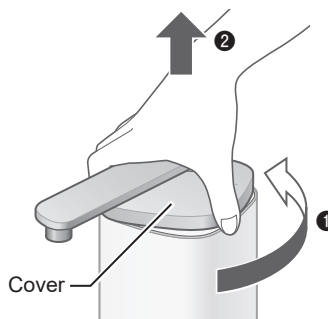

2 Remove the battery cover and replace the batteries.

- 1 Push the hook.
- 2 Remove it.

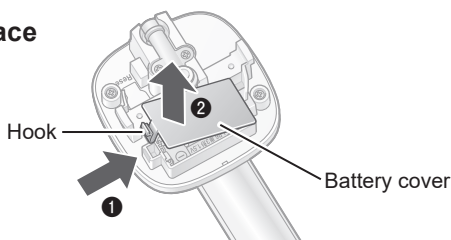

- 3 Check ⊕ and ⊖, and insert the batteries all the way.
- Displays the remaining amount of the cartridge. (P. EN8)

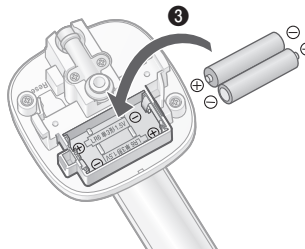

- 4 Insert the projection of the battery cover into the hole.
- 5 Close the battery cover.

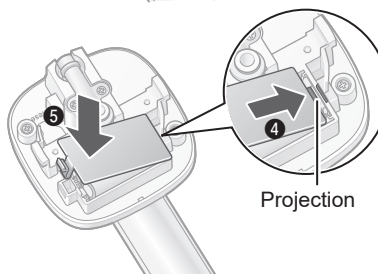

Proceed to **Step 3**
on the next page

English

EN7

Installation 2 Inserting of the batteries into the main unit (continued)

3 Attach the cover.

- 1 Match the two hooks of the cover with the two cutouts of the main unit.

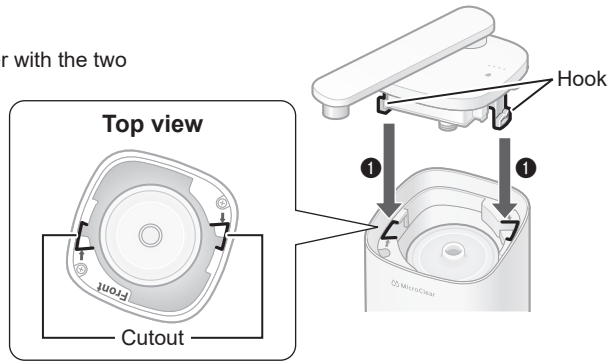

- 2 Turn the cover until it stops.



- If the indicator remains off while purified water is running, replace the batteries with new ones.

< All off >

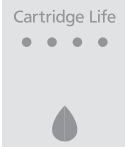

- **It is time to replace the batteries.**
Replace them with new ones.

- Approximate battery life: About 1 year
- Panasonic batteries are recommended.
- Replacing the batteries does not reset the remaining amount (approximate) of the cartridge. The indicator will show the remaining amount just before the replacement.

(Example)

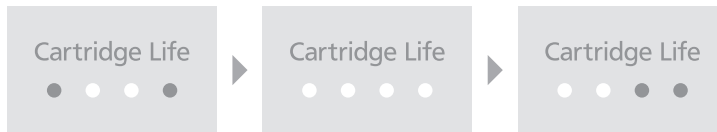

Displays the remaining amount of the cartridge.
(Approx. 3 seconds)

- Disposal of batteries: Insulate the batteries by applying adhesive tape to ⊕ and ⊖. Follow your local disposal rule to dispose of them.

Installation 3 Check the shape of faucet

Water faucet to which the Water Purifier cannot be installed

Faucet without a metal lip end

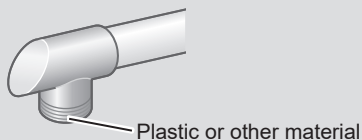

Faucet with an end of 10 mm or less

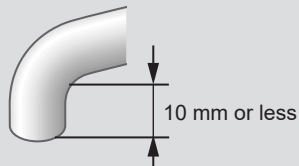

Shower nozzle

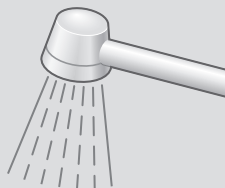

Faucet with sensor



Note

Faucet with a flaring end

- The type of faucet shown at right can be installed using the option.

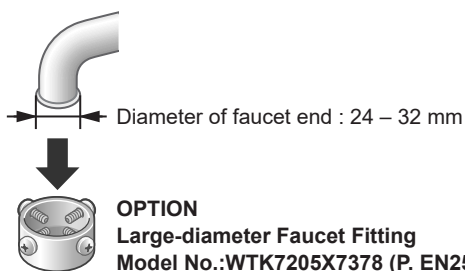

Installation 4 Attach the bypass selector

Keep all parts that are not used during installation, as they may be needed later if the unit is moved or the faucet is changed.

Outside-screwed faucet

- Water faucet to which the bypass selector can be installed without any accessory.

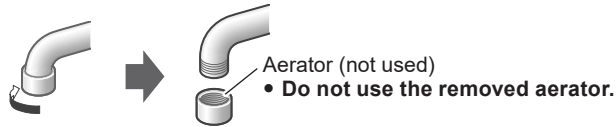

1 Remove the nut and adaptor.

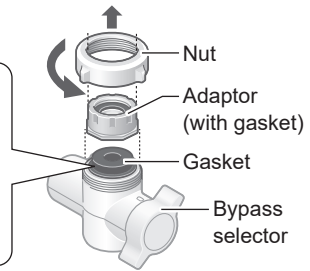
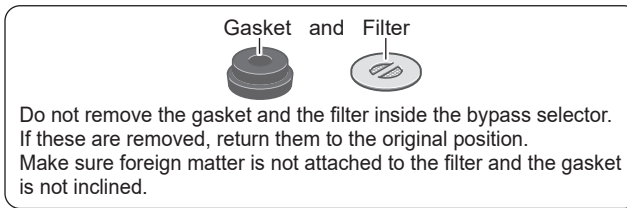

2 Attach the nut and adaptor.

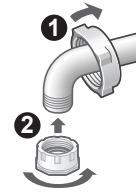

3 Attach the bypass selector and tighten the nut until the bypass selector does not turn.

- Do not use any tools.
(Doing so may damage the nut.)
- Make sure the bypass selector is not inclined.

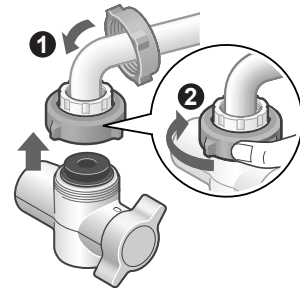

Installation 4 Attach the bypass selector (continued)

Keep all parts that are not used during installation, as they may be needed later if the unit is moved or the faucet is changed.

Inside-screwed faucet

- Water faucet to which the bypass selector can be installed with an accessory.

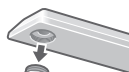

Aerator (not used)

- Do not use the removed aerator.

- 1 Screw in the bushing. Insert it into the bypass selector.**

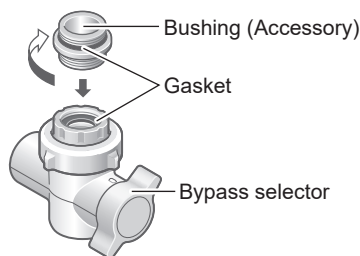

- 2 Attach the bypass selector and tighten it securely.**

- The bypass selector should be screwed straight. Screwing it at an angle may strip the threads, resulting in water leaks.
- Do not use any tools. (Doing so may damage the nut.)
- When water leak occurs after attaching the nut and adaptor
Use the gasket attached on the faucet.

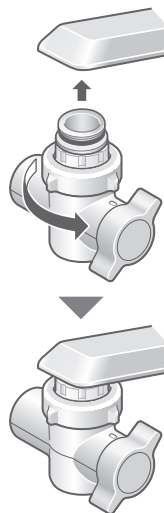

English

EN11

Installation 4 Attach the bypass selector (continued)

Keep all parts that are not used during installation, as they may be needed later if the unit is moved or the faucet is changed.

Faucet without an aerator

- Water faucet to which the bypass selector can be installed with an accessory.

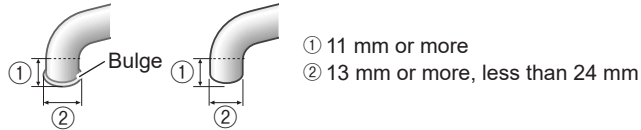

1 Remove the nut and adaptor.

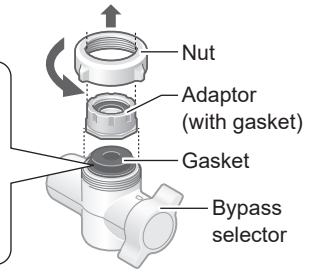
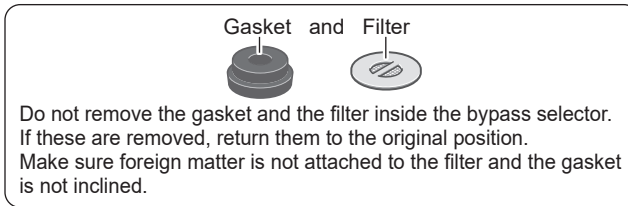

2 Insert the installation adaptor, and tighten it with the nut.

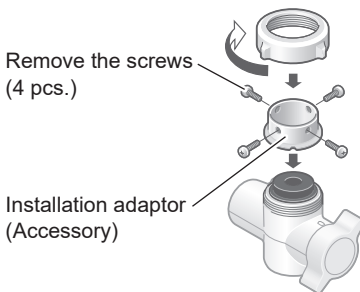

4 Push the bypass selector against the faucet and install the 4 screws as shown below.

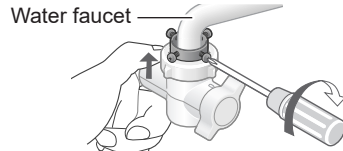

- Top view

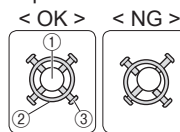

- ① Water faucet
- ② Installation adaptor
- ③ Screws

3 Tighten the 4 screws temporarily and loosen the nut to leave a 3 to 4 mm gap.

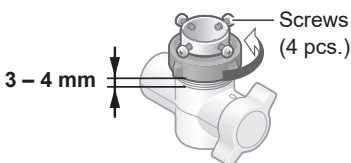

5 Tighten the nut until the bypass selector does not turn.

- Do not use any tools. (Doing so may damage the nut.)
- Make sure the bypass selector is not inclined.

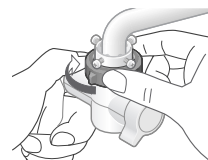

Installation 5 Install the Water Purifier

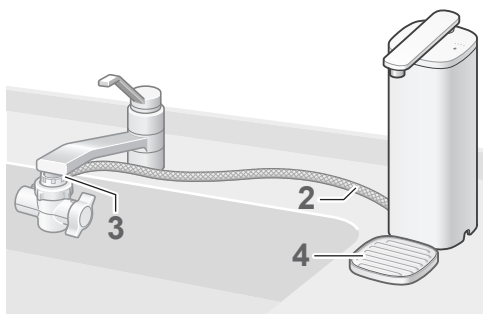

1 Choose a stable, level surface.

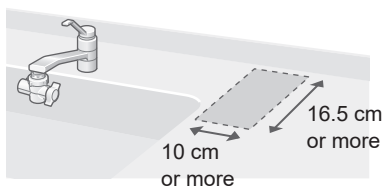

2 Determine the most convenient location for the main unit, and then decide the direction to extend the hose (using the opening section).

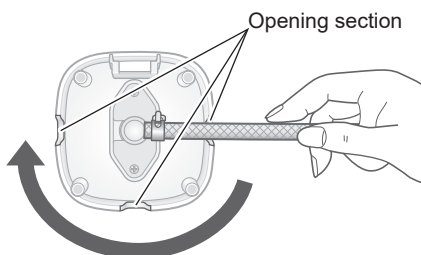

3 After completing the preparations, connect the hose.

- ① Remove the hose fastening nut from the bypass selector, and pass the hose through the nut.
- ② Insert the hose into the bypass selector as far as it will go.
- ③ Tighten up the hose fastening nut securely.
 - Do not use any tools for this assembly (since the hose fastening nut may be damaged).

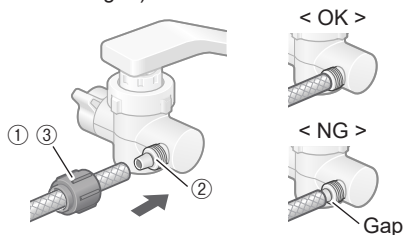

4 Set the tray.

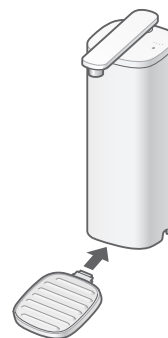





Installation 6 Check after installation

1 Run purified water for about 3 to 4 minutes to expel the air inside the main unit.

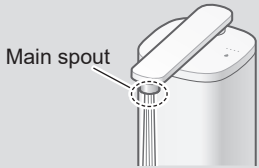
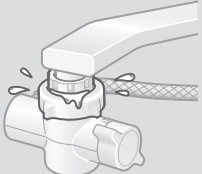
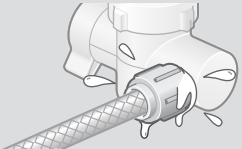
- ① Set the bypass selector to “”.
- ② Turn on the water faucet to let the water flow.
 - If air is not removed, water is poorly drained off from the main spout when stopped.
 - The indicator lighting may become unstable.

2 Check the items on P. EN14. In the case of abnormality, refer to the actions to be taken for each part.

Check item	Trouble inspection location and remedial action	Reference page
<p>Is water coming out of the main spout?</p> 	<ul style="list-style-type: none"> ▶ ● Is the hose bent or flattened? → If it is, straighten it. 	EN13
<p>Is there any water leakage from the joint of the bypass selector?</p> 	<ul style="list-style-type: none"> ▶ ● Has the bypass selector been installed securely on the faucet? → Check again the instructions for “Attach the bypass selector”, and install it securely. ▶ ● Have the parts inside the bypass selector been inserted properly? → If not, install them properly. ▶ ● Are there any cracks at the end of the faucet (in the insulating cap, for instance)? → Consult a plumber. 	EN10-EN12 EN10-EN12 —
<p>Is there any water leakage from the joint of the hose?</p> 	<ul style="list-style-type: none"> ▶ ● Has the hose been attached securely to the bypass selector? → Insert it as far as it will go, and use the hose fastening nut to secure it. <div style="display: flex; justify-content: space-around; align-items: center;"> <div style="text-align: center;"> <p>< OK ></p>  </div> <div style="text-align: center;"> <p>< NG ></p>  </div> </div>	EN13
<p>Is water leaking from the faucet?</p> 	<ul style="list-style-type: none"> ▶ ● Is the gasket on the faucet old? → Consult a plumber. ▶ ● Are there any cracks in the faucet (in the insulating cap, for instance)? → Consult a plumber. 	— —

EN14

How to Use

1 Set the bypass selector to

“ . ♀ ” : Purified water

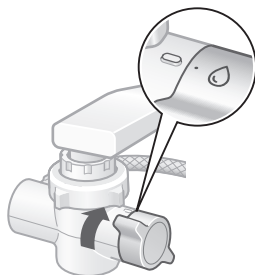

“ . ♂ ” : Unpurified

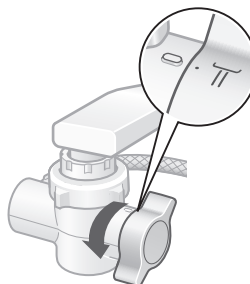

2 Open the faucet.

- At the beginning of daily use, run water approx. 0.6 liters (approx. 18 seconds) before using. (P. EN4)

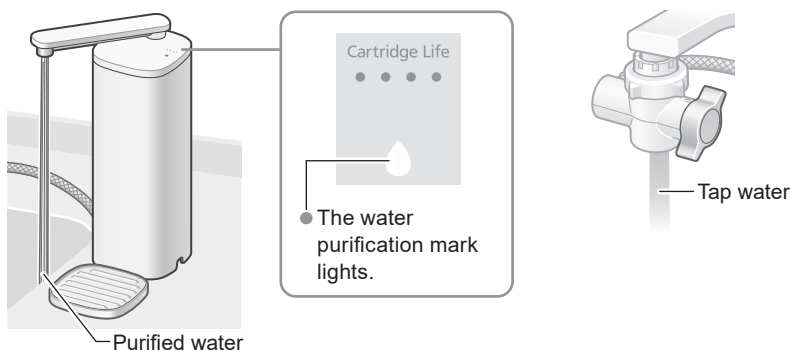

Note

- If water is discharged when the batteries are flat, the water will be purified however water volume or usage time used as the reference for replacing the cartridge will not be counted, and the cartridge life will not be displayed correctly.

3 After use, close the faucet.

- Water may come out slightly from the main spout even after the water flow is stopped. It is not a malfunction. (This is water remaining in the outlet pipe.)
- Stopping water purification causes water purification mark to turn off and the cartridge life indicator to light. (Approx. 3 seconds) (P. EN18)

Maintenance

Important

- Do not use detergents, cleansers, paint thinners, benzene, alcohol or kerosene for cleaning purposes. If, for instance, a detergent is used by mistake, wipe the surface with a damp cloth immediately to remove all traces of the detergent. Otherwise,
 - The detergent may get mixed in with the water running through the Water Purifier, the plated parts maybe damaged or peel off.
 - The plastic parts may become damaged, discolored or deformed.
 - Use of cleansers may also impair the workings of the outlet pipe and cause trouble.
- Do not use brushes or other implements made of metal (since they may leave scratch marks).
- Do not use a tool to tighten up the nut (since the nut may be damaged).

Main unit, bypass selector, outlet pipe, and tray

Soak a soft cloth in water, wring it out well, and use it to wipe the units and parts.

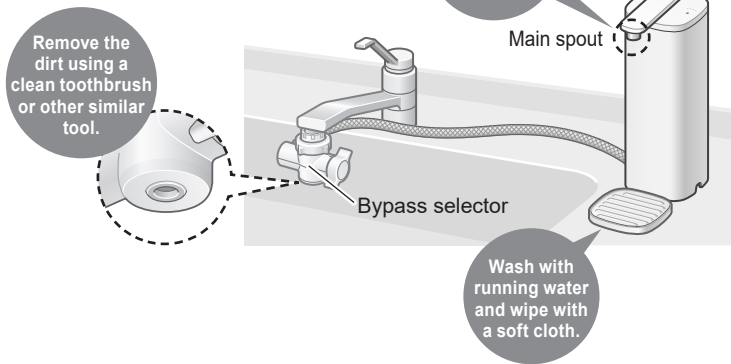

Maintenance (continued)

Bypass selector mounting part

Remove the bypass selector, then rinse the filter and water intake.

- The water flow may decrease when the filter in the bypass selector connection area becomes clogged with impurities.

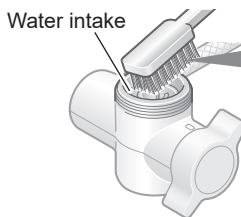

Once a year

Using a clean toothbrush or similar tools

How to remove

- ① Set the bypass selector to “· · ·”.

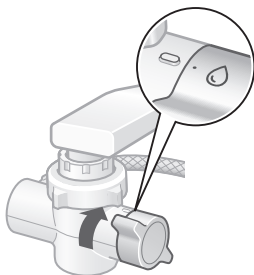

- ② Loosen the nut, remove the bypass selector, and take out the gasket and filter.

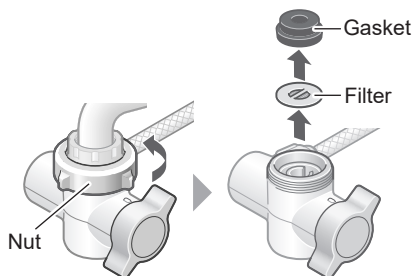

How to attach

Be sure to follow this order.

- ① Reinstall

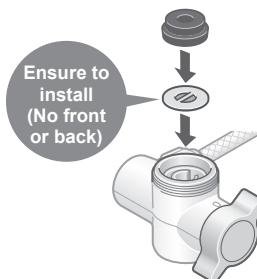

- ② Securely tighten the nut.
- ③ After mounting the bypass selector, set the lever to “· · ·” and allow water to flow for about 5 seconds.

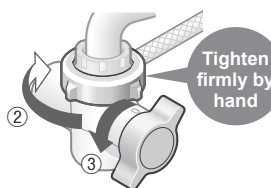

Replacing the Cartridge

When the service life of the cartridge is to be expired or the water purifying ability is reduced, please replace the cartridge with a new one.

Also, replacing the batteries at the time is recommended since they may be consumed more rapidly than expected. (P. EN7-EN8)



Replacement cartridge

Model No:
TK-AS700C-EX
(P. EN26)

Cartridge replacement guideline

The following shows the 4 replacement guidelines. If 1 of the following conditions is met, please replace the cartridge.

The using time is about 1 year.

The total water flow volume reaches 6 000 L.*

The flow of purified water is extremely low. (The cartridge is blocked.)

The water smells or tastes bad.

* Purification capacity (P. EN26)

- Inside the cartridge is a hollow fiber membrane filter for removing microscopic dirt. The cartridge's life will be shortened when the Water Purifier is used with a quality of water containing many clogging substances.

About the Cartridge Life Display

The cartridge level indicates the water volume or period of use.

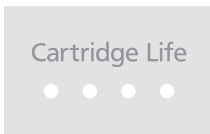

(Lights for approx. 3 seconds)

Estimated period of use and remaining amount	
	Less than 3 months from the start of use, or 4 500 L to 6 000 L are remaining
	3 months or more to less than 6 months of use, or 3 000 L or more to less than 4 500 L are remaining
	6 months or more to less than 9 months of use, or 1 500 L or more to less than 3 000 L are remaining
	9 months or more of use, or 150 L or more to less than 1 500 L are remaining

When one lamp of the cartridge life indicator blinks



(Blinks for approx. 3 seconds)

The replacement timing is approaching.

Please a new cartridge.

- The lamp blinks when the estimated time until replacement is approx. 10 days or less or when the estimated remaining amount until replacement is approx. 150 L or less.

When four lamps of the cartridge life indicator blink

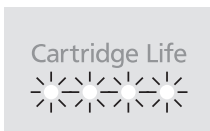

(Blink for approx. 10 seconds)

The period of use exceeded 1 year or the total water flow volume exceeded 6 000 L.

Replace the cartridge.

- The estimated replacement time may differ by approx. 10 days.
- Once you turn on purified water after the indicator blinks approx. 10 seconds, it will come to blink approx. 3 seconds each time you turn it off.
- Water purification mark remains off.

Replacing the Cartridge (continued)

Replacing method

- Before replacing the cartridge, turn off the faucet. Do not run water through the Water Purifier with the cartridge removed.
(Doing so may cause the water to overflow.)
- Dispose of the used cartridge in accordance with the applicable ordinances in the area concerned.
(The material of the cartridge cover is ABS. For the type of the filter materials, refer to P. EN26.)

Preparation: Please turn off the faucet.

1 Remove the cover.

- 1 Turn the cover until it comes in contact with the stopper.
 - 2 Raise the cover.
- Do not hold the outlet pipe to turn the cover.
(Doing so may cause malfunction.)

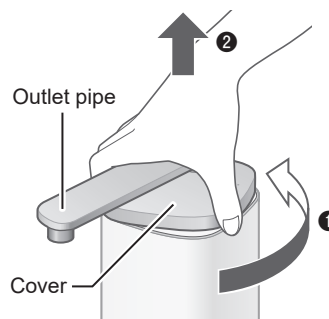

2 Remove the old cartridge.

- If there are water drops inside the main unit, wipe them off with a soft cloth.

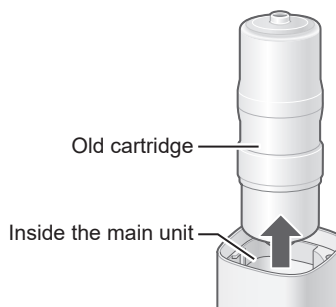

3 Install the new cartridge.

Fit new cartridge into the case.

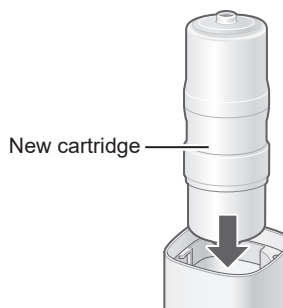

Proceed to **Step 4**
on the next page

EN19

English

Replacing the Cartridge (continued)

4 Press the reset button (for approx. 3 seconds).

- The four lamps of the cartridge life indicator light. (Approx. 3 seconds) (P. EN18)

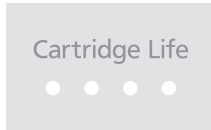

- Be sure to press reset button even when it is replaced earlier than the replacement timing. (To display the next replacement timing correctly)

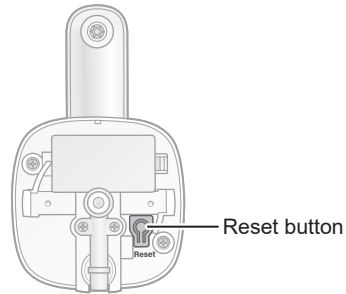

5 Attach the cover.

- 1 Match the two hooks of the cover with the two cutouts of the main unit.

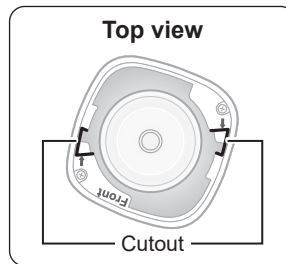

- 2 Turn the cover until it stops.



6 Open the faucet, and run purified water through the main unit. (for about 3 or 4 minutes)

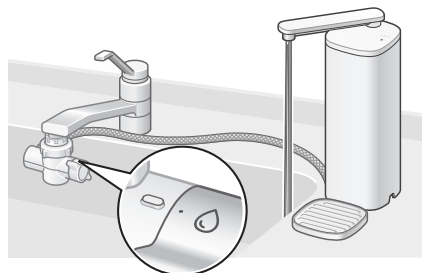

When the Water Supply is Cut Off

- The Water Purifier cannot be used. If the water is cut off during use, turn off the faucet.
- When the water supply is restored, set the bypass selector to “” and first run unpurified water (tap water) into the sink to remove the air and turbid water inside the pipes. The Water Purifier may then be used again as usual. (This is to prevent the cartridge life from being significantly shortened.)

When Not in Use for a Long Periods

■ When not used for approx. 1 week or longer

- Remove the cartridge (P. EN19-EN20), and store it sealed in a vinyl bag in a refrigerator.
- Remove air from the bag, and close the opening.

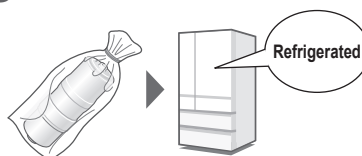

Note

- Storing the cartridge for a prolonged period may alter the quality of the water within the cartridge, so replacing the cartridge is recommended.

■ To use this unit again

- ① Install the cartridge (P. EN19-EN20)
- ② Run water for approx. 3 minutes, and check before using that there is no water leak.

When Moving the Water Purifier

Remove water from the main unit with the following steps before moving the product.

- Stand the main unit while moving. After removing the water, a small amount of water may remain, so put the main unit in a bag, etc.

1 Disconnect the hose.

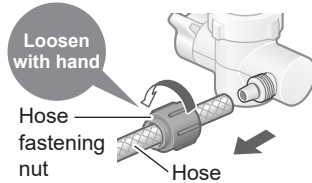

- After disconnecting the hose, attach the hose fastening nut to the original position of the bypass selector (loss prevention).

2 Remove the cartridge. (P. EN19)

3 Put the tip of the hose at a position lower than the main unit, and discharge the water remaining in the hose.

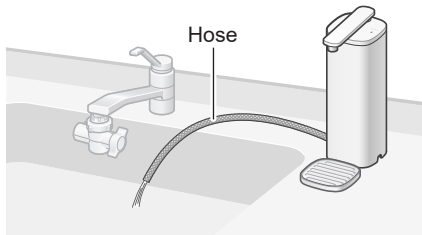

4 Attach the cartridge and the cover to the original position. (P. EN19-EN20)

5 Loosen the nut, remove the bypass selector, and remove the water inside.

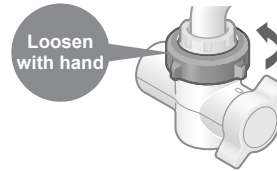

■ When the joint is difficult to remove

After tightening the nut firmly with hand, rotate it together with the bypass selector. Then it can be removed easily.

- If it still cannot be removed, use a tool such as a plier to nip the adaptor, and remove it.
- When using a tool such as a plier, protect the joint with cloth, etc. not to damage it, and pay attention to the rotation direction.

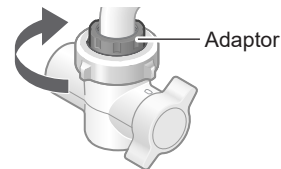

Q&A

	Question	Answer
Cartridge	What is the part number of the cartridge for replacement?	TK-AS700C-EX (P. EN26)
	Is it possible to use the cartridge exceeding the amount of 6 000 liters?	For usage, we have confirmed a removal capacity of 6 000 liters by running water. The cartridge cannot be used beyond the amount. (Depending on the water quality, it may not be used even less than 6 000 liters.) When using 15 liters of water per day, it is recommended to replace the cartridge in approx. 1 years.
Tap water	Can I use underground water or well water?	Only the water that has passed a test for drinking can be used.
	Up to what temperature can I use for hot water?	Water with a temperature of less than 35 °C can be used. (P. EN5) When the bypass selector is adjusted to “  ”, water with a temperature of less than 80 °C can be used.
Purified water	How long do the purified water last?	Use it within 1 day at room temperature. When purified water is produced, chlorine (sterilizer) in tap water is removed, making it easier for bacteria to proliferate. <ul style="list-style-type: none"> • When storing purified water in the refrigerator, keep it in a clean sealed container, and use it within 2 days.
Others	White powder is attached on the kettle or electric thermos flask	It is calcium from the water. Drinking the water is not a problem, but if it bothers you, clean the containers. <ul style="list-style-type: none"> • If the white powder is not removed by cleaning, dissolve 50 g of citric acid in 1 liter of water, and soak the container in the solution for 2 to 3 days. Then rinse off the deposit. (Buy citric acid at a pharmacy.)

Before Requesting a Repair Service

First, check P. EN24 to P. EN25.

If the problem is not solved after the following contents are checked, contact the dealer where you purchased the product.

	Problem	Check point
Display	Although water flow is not stopped, the cartridge replacement guideline is displayed	<ul style="list-style-type: none"> ● Is the amount of water flow too small? (less than approx. 0.7 liter/min) <ul style="list-style-type: none"> ● The flow volume may have decreased due to change in water pressure. ● Flow more water.
	The water purification mark does not light while purified water is being supplied	<ul style="list-style-type: none"> ● Are the batteries depleted? <ul style="list-style-type: none"> → Replace the batteries with new ones. (P. EN7-EN8) ● Are the batteries reversely inserted? <ul style="list-style-type: none"> → Insert the batteries correctly. (P. EN7-EN8) ● Is the amount of water flow too small? <ul style="list-style-type: none"> → Flow more water. → Replace the cartridge with a new one. (P. EN18-EN20)
Water leakage	Faucet and connection parts of bypass selector and hose	<ul style="list-style-type: none"> ● See P. EN14.
	Bypass selector (location other than the water outlet selected with the bypass selector) Though the bypass selector is adjusted to "・  " , water drips from the source water opening.	<ul style="list-style-type: none"> ● The cause seems to be calcium, etc. depositing inside the bypass selector. <ul style="list-style-type: none"> → Dissolve approx. 50 g of citric acid in 1 liter of water. Remove the bypass selector (P. EN17) and hose, soak them in the citric acid water for approx. 12 hours, and wash them with water. (Buy citric acid at a pharmacy.)
Main spout	Water drips or trickles out of the main spout even when the water is stopped	<ul style="list-style-type: none"> ● This is not a malfunction. (This is water remaining in the outlet pipe.)
	No water or a small amount of water is coming out	<ul style="list-style-type: none"> ● Is the faucet fully open? ● Is the filter of the bypass selector clogged? <ul style="list-style-type: none"> → Perform maintenance. (P. EN16-EN17) ● Has the water supply been cut off? (P. EN21) ● Is the hose bent or flattened? <p>If the problem is still not solved after all of the above are checked, the cartridge may be clogged. Replace the cartridge. (P. EN19-EN20)</p>
	The amount of water coming out has decreased after the cartridge is replaced	<ul style="list-style-type: none"> ● Did you run water for approx. 3 to 4 minutes after replacement? (P. EN20) <ul style="list-style-type: none"> (It is necessary to remove the air inside the cartridge)

Before Requesting a Repair Service (continued)

Problem	Check point
<p>Odor, taste, turbidness, and change in color</p> <p>The water produced by the Water Purifier has an odor or unpleasant taste or is turbid</p>	<ul style="list-style-type: none">● Purification performance of the cartridge is deteriorated. → Replace the cartridge. (P. EN19-EN20)

Optional Accessories

Obtain all optional accessories from your dealer.

For details on how they are used, refer to the accompanying instructions.

Consumables

Replacement cartridge

Model No: TK-AS700C-EX
(P. EN26)

For use with large faucet

Large-diameter Faucet Fitting (inside diameter 32.5 mm)

Model No : WTK7205X7378

- For faucets whose end diameter is 24 – 32 mm

Specifications

Main materials	Main unit	ABS resin	
	Bypass selector	ABS resin	
	Hose	Vinyl chloride	
Main unit	Dimensions	Approx. 100(W) × 165(D) × 292(H) mm	
	Weight	Approx. 1.0 kg (approx. 1.4 kg when full of water)	
Temperature of water used by Water Purifier		Under 35 °C (under 80 °C for bypass selector)	
The lowest applicable dynamic water pressure		70 kPa	
Pressure of water used by Water Purifier (dynamic pressure)		70 kPa to 350 kPa	
Usable water service pressure (static pressure)		70 kPa to 750 kPa	
Filtration flow volume		1.6 L/min [at 100 kPa water pressure]	
Cartridge Installed In the unit		TK-AS700C-EX	
Purification capacity	Free residual chlorine	6 000 L	(*1)
	Turbidity	6 000 L	(*2)
	Chloroform	6 000 L	(*3)
	Total trihalomethane	6 000 L	(*3)
	Bromodichloromethane	6 000 L	(*3)
	Dibromochloromethane	6 000 L	(*3)
	Bromoform	6 000 L	(*3)
	Tetrachloroethylene	6 000 L	(*3)
	Trichloroethylene	6 000 L	(*3)
	CAT (pesticide)	6 000 L	(*1)
	2-MIB (mold smell)	6 000 L	(*1)
	Soluble lead	6 000 L	(*1)
	1,2-DCE	6 000 L	(*3)
	Benzene	6 000 L	(*3)
	Geosmin (mold smell)	6 000 L	(*1)
Phenols	6 000 L	(*1)	
PFOS and PFOA	6 000 L	(*4)	
Removable substances other than those shown above	Iron (particulate form)	Can be removed	(*5)
	Aluminium (neutral)	Can be removed	(*5)
Guide for time to replace cartridge	Approx. 1 year		(*6)
Filter material	Non-woven fabric, activated carbon, ceramic, hollow fiber membrane		
Components which cannot be filtered out	Iron dissolved in water, heavy metals (silver, copper, etc.), salt (seawater)		
Power supply for display	Alkaline Battery		
Battery	Two LR6 (AA Alkaline Battery) (sold separately)		
Operating time	Approx. 3 year (When two Panasonic LR6 (AA Alkaline Battery) are used, and the room temperature is 20 °C)		

- All figures given are for a water temperature of 20 °C.
- Activated carbon uses powdered activated carbon and granular activated carbon.
- This product cannot convert hard water into soft water.

(*1) This value is for a removal rate of 80 % based on JIS S 3201 tests.

(*2) This value is for a filtration flow volume of 50 % based on JIS S 3201 tests.

(*3) This value is for a removal rate of 80 % based on JIS S 3201 Annex A tests.

(*4) This value is for a removal rate of 80 % based on specification standard tests (JWPAS B standards) stipulated by the Japan Water Purifier Association (JWPA).

(*5) This substance is for a removal rate of 80 % based on specification standard tests (JWPAS B standards) stipulated by the Japan Water Purifier Association (JWPA). Note that it is not stipulated as part of purification capacity.

(*6) This period applies when 15 liters of water are used a day. If 30 liters are used a day, the cartridge usage limit will be one-half. The period may also be significantly less depending on the amount of water used and on its quality and pressure.

Panasonic Corporation
<https://www.panasonic.com>
© Panasonic Corporation 2024



ZGS0TKCS6000Z
Y1024-0
Printed in Japan