

Panasonic®

INSTALLATION AND OPERATING INSTRUCTIONS ELECTRIC FAN

Model No. **F-19GNH**

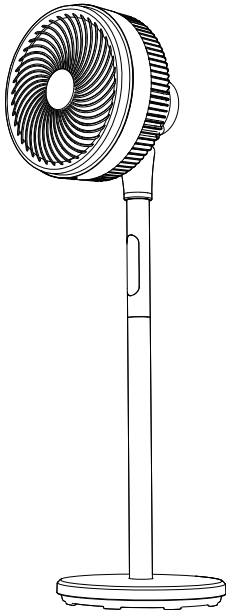

CONTENTS

SAFETY INSTRUCTIONS.....	2
SAFETY PRECAUTIONS	2~5
OPERATING REQUIREMENTS	6
SUPPLIED ACCESSORIES.....	6
PART NAMES AND DIMENSIONS	6
HOW TO INSTALL	7
OPERATING METHOD	7~10
MAINTENANCE.....	10~11
TROUBLESHOOTING.....	11
WIRING DIAGRAM	12
SPECIFICATIONS.....	12

Product warranty card attached

Thank you very much for purchasing this Panasonic product.
Please read these instructions carefully before attempting to install,
operate or service the product. Also, be sure to read the "SAFETY
PRECAUTIONS" (P.2~5) section before installation and operation. Failure
to comply with instructions could result in injury or property damage.
Keep the product warranty card in a safe space along with the instructions
for future reference.

SAFETY INSTRUCTIONS

Please observe strictly

- Disconnect power supply before maintenance.
- This product can only be charged with the attached power adapter.
- If the adapter is damaged, it must be replaced by a special cord or assembly available from the manufacturer or its service agent.
- This product is not intended for use by persons (including children) with reduced physical, sensory or mental capabilities, or lack of experience and knowledge, unless they have been given supervision or instruction concerning use of the product by a person responsible for the safety. Children should be supervised to ensure that they do not play with the product.

The safety precautions in the instructions should be strictly followed in order to prevent injury or damage to properties.

- The following symbols differentiate the levels of danger or injury that may result if it is not used correctly as instructed.



Those things shown in this column indicate that there is possibility of causing death or severe injury.



Those things shown in this column indicate that there is possibility of causing minor injury or damage to properties.

- The following symbols are used to indicate the type of instructions that need to be followed. (The symbols given below are examples)



This symbol indicates an action that must not be performed.



This symbol indicates an action that must be performed.

SAFETY PRECAUTIONS



WARNING



- Do not connect the power adapter when product installation is incomplete. When carrying the product, please disconnect the power adapter.

(Otherwise, electric shock or injury may occur.)

- Do not connect and disconnect the power adapter with wet hands. (Otherwise, electric shock may occur.)



- Do not use power other than the rated voltage.

(Otherwise, the power adapter may be overheated and induce fire.)

- Do not place or use flammable materials or aerosol cans near the electric fan.

(Otherwise, poisoning or fire may occur.)

SAFETY PRECAUTIONS

WARNING

-  ■ **Do not operate the product when the blades and guard is not installed.**
(Otherwise, electric shock or injury may occur.)
- **Do not put the electric fan in water or pour water on it.**
(Otherwise, it may short circuit with the possibility of electric shock or fire.)
- **Do not operate the product in the following places.**
Do not expose the electric fan to open flames such as gas stoves, places containing flammable gases or aerosol cans, and places with rain or splashes, high temperature, high humidity, a lot of oil, dust and metal powder.
(Otherwise, it may short circuit with the possibility of electric shock or fire.)
- **If power cord or power adapter is damaged, or power socket is loose, do not use it.**
(Otherwise, it may heat up, and electric shock or fire may occur.)
- **Do not insert the power adapter when assembling, disassembling or cleaning the product.**
(Otherwise, electric shock or injury may occur.)

-  ■ **Do not put the battery in reach of children and infants.**
(Swallowing can lead to chemical burns, perforation of soft tissue, and death. Severe burns can occur within 2 h of ingestion. Seek medical attention immediately.)
- **Do not break, modify or put battery into fire or heat. Do not expose the battery to excessive temperatures and be aware of the risk of battery being short circuited by metal objects.**
(If the insulation or exhaust value is damaged, the battery may leakage or become hot, crack.)

-  ■ **Please promptly take out the battery from the remote control when the battery is exhausted or if you will not use the remote control for a period of time.**
(Otherwise, battery may leakage or become hot, crack.)
- **Please observe the following when using the batteries.**
 - Do not inversely install the positive pole and negative pole of batteries.
 - Do not short circuit.
 - Non-rechargeable batteries should not be recharged.
 - Do not use modified or damaged batteries.
(Otherwise, a leakage or damage may be caused.)

SAFETY PRECAUTIONS

WARNING

 ■ **Do not disassemble, repair or modify the product except for maintenance technicians.**
(Otherwise, the product may malfunction or catch fire, thus resulting in fire or electric shock.)

■ **Do not damage or modify the power adapter, or forcibly bend, strain, tighten, or twist it.**
(Otherwise, the power adapter may be damaged with the possibility of fire or electric shock.)

 ■ **Be sure to insert the power adapter completely.**
(If the power adapter is not fully inserted, the power adapter may be overheated, thus resulting in fire or electric shock.)

■ **Turn off the power and unplug the power adapter when leaving the product unattended for a long time or when the product is not in use, or the product will not be in use for a long time.**
(Otherwise, there may be a power failure, and an accident may occur.)

CAUTION

 ■ **Do not insert fingers, sharp objects, or any other items into the vent while the product is running.**
(Otherwise, you may be hurt by the inner units with the possibility of injury.)

■ **Do not use the product near acids, alkalis and oily substances, insecticides, curtains and other items.**
(Otherwise, you may feel uncomfortable or be hurt due to items being drawn into the product.)

 ■ **Do not use the product on unstable surfaces or near obstacles.**
(Otherwise, the product may fall over and injury may occur.)

■ **Do not use the product under direct sunlight or in areas with extremely high humidity.**
(Otherwise, short circuit may occur etc. with the possibility of electric shock or fire.)

■ **Do not use the product near fire, fuel or chemicals.**
(Otherwise, current may leak with the possibility of fire or electric shock.)

SAFETY PRECAUTIONS



CAUTION



- **Do not pour water or other liquids on the body, control panel or remote control of the product.**

(Otherwise, it may short circuit with the possibility of electric shock or fire.)

- **Do not apply pesticides or use chemicals on the electric fan.**

(Otherwise, the electric fan may discolor, and the pesticides may be discharged from the vents, posing a health risk.)

- **Do not use the product in damp areas such as bathrooms, waterlogged floors, or wet carpets.**

(Otherwise, electric shock may occur.)

- **Do not cover the product with clothes, towels or bedding.**

(Otherwise, the product may be damaged, or electric shock, fire, or smoke may occur.)

- **Do not use the product where objects may fall.**

(Otherwise, the product may be damaged.)

- **Do not attempt to manipulate the guard with your hands while the electric fan is running.**

(Otherwise, you may be hurt, or the product may be damaged.)



- **Do not attempt to force the swing mechanism with your hands while the electric fan is in standby or operation.**

(Otherwise, you may be hurt, or the product may be damaged.)



- **If any abnormalities occur (vibration, noise, odor, etc.), stop the operation and unplug the power adapter.**

(Otherwise, electric shock, fire or smoke may occur.)

- **Make sure that the guard is not loose.**

(Otherwise, it may fall off and cause injuries.)

- **Keep the product at least 2 m away from electronic equipment such as TVs and radios.**

(Otherwise, visual disturbances or noises may be caused.)

- **Before using the product, make sure that the column and the base module are tightly assembled.**

(Otherwise, the product is easily turned over and results in injury.)

OPERATING REQUIREMENTS

- Make sure that the product is placed on a flat and stable floor.
- Make sure that the electric outlet is near the electric fan for easy access.
- Please always place the power adapter properly to prevent tripping.

SUPPLIED ACCESSORIES

The following attachments are enclosed in the packing box. Be sure to check if they are complete after unpacking, and if anything is missed, contact customer consultation service center or your distributor.

No.	Name	Qty
1	Remote control	1
2	Power adapter	1
3	Installation and operating instructions	1
4	Product warranty card	1

PART NAMES AND DIMENSIONS

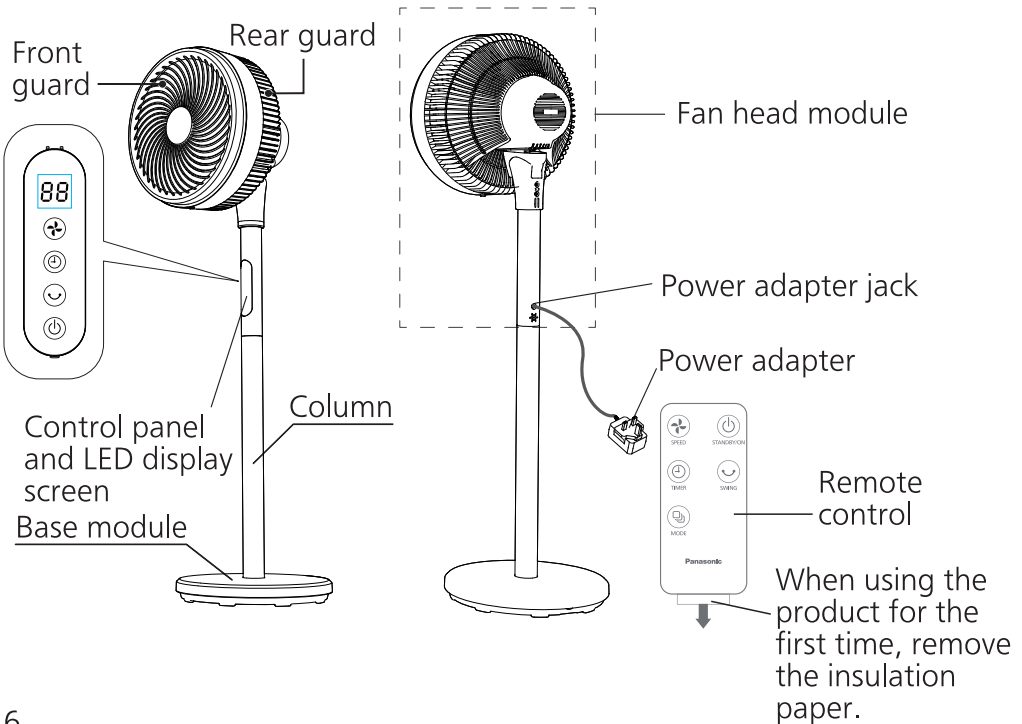

HOW TO INSTALL

■ Installation of Floor Fan

- ① Rotate to connect the fan head assembly with the column.
- ② Rotate to connect the column with the base.

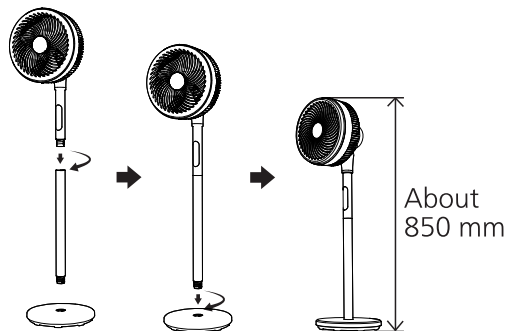

■ Installation of Table Fan

Rotate to connect the fan head module with the base.

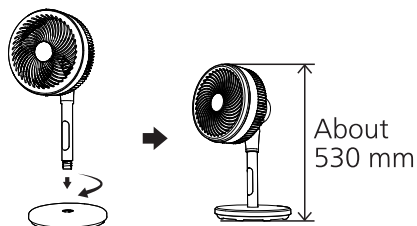

⚠ CAUTION



■ While using the product, make sure that the column and the base module are tightly assembled.

(Otherwise, the product is easily turned over and results in injury.)

OPERATING METHOD

■ Control panel

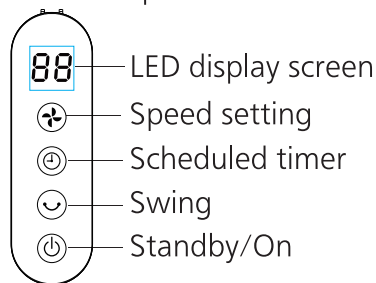

Note:

- The display screen will automatically turn off if no operation on the fan. You can press any button to reactivate it.
- When the electric fan is running, it will turn to standby mode at around 24 hours of no operation automatically.
- In standby mode, the electric fan is still powered on, but not running.

■ Remote control

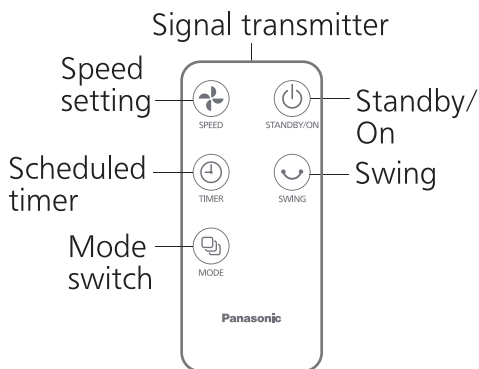

- You can use 1 remote control for multiple electric fans.

OPERATING METHOD

■ Replacement of Remote Control Battery

- It is necessary to replace the battery when the remote control's performance reduces and the range decreases.
- If the battery is not handled properly, failure or injury may occur due to battery damage or liquid leakage.
- While the battery is placed in the remote control during factory shipment for testing purposes, its service life may be shortened due to self-discharge.
- Do not use batteries other than those specified.
※CR2025 available in the market is recommended.

Battery installation: as shown in the figure, press the buckle and pull out the battery cover in the direction of the arrow. After placing the battery on the battery cover with the mark "+" facing upward, close the cover.

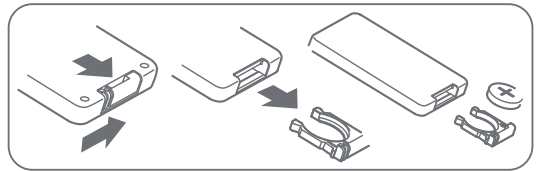

■ When the battery leaks, avoid direct skin contact with the battery, and dispose the battery.

■ Please comply with local laws and regulations when dispose the battery.

■ Operation of Electric Fan

Standby/On



Product control panel



STANDBY/ON

Remote control panel

- Press this button to turn on the electric fan while it is in standby mode, and press this button to put the electric fan in standby mode while it is running. The electric fan runs at the default speed setting of level 3 without swing upon first startup.

- When power is disconnected, the electric fan will start at the default speed setting of level 3 without swing.

Speed setting



Product control panel



SPEED

Remote control panel

- Short press: Switchover.

- Long press: Speed up the speed setting shifting (applicable to the product control panel only, not the remote control).

*The electric fan has 12 levels. It is suitable for various modes of operation.

OPERATING METHOD

Mode switch



MODE

Remote control

With each press on the button of the remote control, the mode changes in this sequence:

"Normal → CF (Natural) → SL (Sleepy)" and start over.

Normal	The electric fan keeps running at the level set currently (the LED display screen indicates the current level).
CF (Natural)	The speed changes according to the set level.
SL (Sleeping)	The electric fan runs at the level set currently, reducing one level every 30 minutes, with a minimum speed of level 1.

Scheduled standby timer To be set in power-on mode



Product control panel



TIMER

Remote control

In power-on mode, press the "Timer" button to set a scheduled standby timer.

The timer can be adjusted in 1-hour increments, with a maximum of 8 hours, and can be set to repeat. "0 H" indicates that no timer is set.

Once the standby timer is set, the display screen will return to the normal level display, or show "CF" or "SL" after about 5 seconds of no operation. When the "Timer" button is pressed again, the display screen shows the current timer setting. Upon reaching the scheduled standby time, the electric fan enters the standby mode.

1 H → 2 H → 3 H → 4 H → 5 H → 6 H → 7 H → 8 H → 0 H



Scheduled power-on timer



Product control panel



TIMER

Remote control

In standby mode, press the "Timer" button to set a scheduled power-on timer.

In the scheduling setting, the electric fan is set to run at level 3 without swing by default. The setting can be adjusted via the remote control or button on the panel.

After the scheduled power-on timer is set, the display screen will show the current scheduled time after about 5 seconds of no operation.

When the scheduled power-on timer is set, you can press the "Standby/On" button to cancel the setting and power the electric fan immediately, and then it will run at level 3 without swing by default.

*When the scheduled timer is working, the display screen shows the remaining time (countdown).

Swing



Product control panel



SWING

Remote control

Press of the button to switch the swing function On/Off.

OPERATING METHOD

Notice

The product can only be manually adjusted upward and downward. When adjusting, make sure the up-and-down module is adjusted in the direction indicated in the figure as shown.

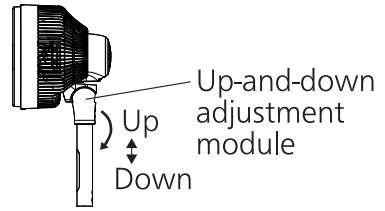

MAINTENANCE

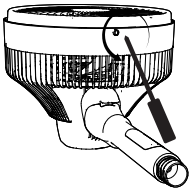

- Turn off the product and unplug the power adapter, let the product cool down, then use a screwdriver tool (to be purchased separately) to rotate the guard set screws at the guard bottom counterclockwise, and remove the screws.

- Rotate the front guard with your hands to align the sign "I" on the front guard with the unlock sign "A" on the rear guard.

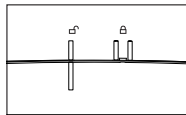
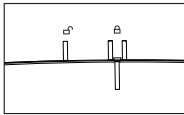

Front guard



Blade

Rear guard

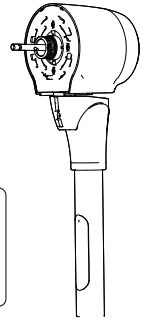
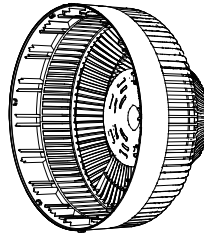
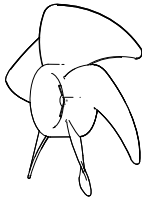
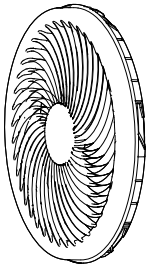
Motor



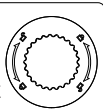

Blade lock nut

Clockwise : Loose
Anticlockwise : Tight



Rear guard lock nut

Anticlockwise : Loose
Clockwise : Tight



- Disassemble the front guard → blade lock nut → blade → rear guard lock nut → rear guard as shown in the figure above, clean the components, and install them when they are fully dried.

- The installation sequence is reversed to the disassembly sequence.

*When installing, it needs to align the sign "I" on the front guard with the sign "A" on the rear guard, then rotate the front guard clockwise to align the sign "I" on the front guard with the sign "A" on the rear guard.

MAINTENANCE

- Before cleaning and maintenance, make sure to unplug the power adapter and disconnect the power. Let the electric fan cool down before cleaning.
- Do not use chemical solvents such as toluene, bleach, or alcohol, or hard brushes to wipe, as this may scratch and corrode the appearance of the electric fan.
- If there are stains or stubborn dirt that cannot be easily removed, it is recommended to use kitchen-specific neutral cleaner and wipe them off with a soft dry cloth.
- It is recommended to regularly check and clean the product to extend its service life.
- Maintenance before Storage
 1. Position the electric fan to face forward, and disassemble it in reversed order to the installation sequence provided in the manual. For detailed installation instructions, please refer to page 7 of the manual.
 2. Do not manually reposition the electric fan to face forward when it is not aligned. Enable the swing function to direct the fan towards the front.
 3. Wipe off any dirt from the motor shaft, apply a thin layer of sewing machine oil for protection.
 4. Put the product in its original packaging and keep it in a place with low humidity.

TROUBLESHOOTING

Common Fault	Possible reason	Solutions
Failure to operate	<ul style="list-style-type: none">*The power adapter is not properly plugged into the power strip or wall outlet, or the electric fan jack is not fully engaged.*The front and rear guards are not properly installed or have deformed and interfered with the blades, or the blades are not properly installed.	<ul style="list-style-type: none">*Plug in and power up again.*Realign and properly install the front and rear guards and blades.
Abnormal noise during running	<ul style="list-style-type: none">*The blades are not properly fitted onto the motor shaft.*The blades are not properly installed or have deformed and been in contact with the guard.*The blade set screw nuts are not tightened.*The front guard is not properly installed.	<ul style="list-style-type: none">*Properly fit the blades onto the motor shaft.*Make sure that the blades are not in contact with the guard.*Tighten the blade set screw nuts.*Align and secure the front and rear guards with screws.

If the fault cannot be resolved, please contact the customer service center or the dealer where you purchased the product for assistance.

WIRING DIAGRAM

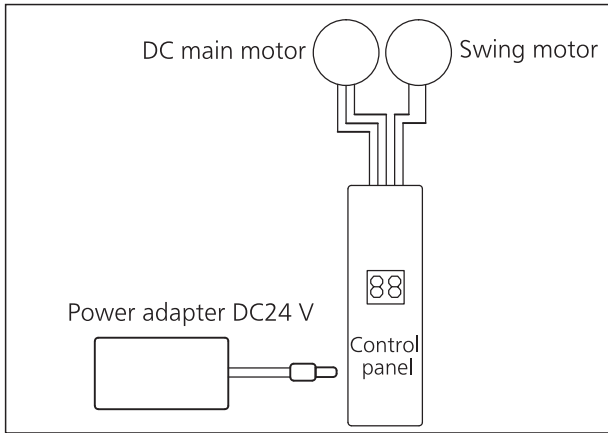

SPECIFICATIONS

Model No.	F-19GNH	Power supply	220 V~ 50 Hz
Product dimension	280 mm×310 mm×850 mm (W×D×H)	Rated Power	24 W
Product net weight	4.0 kg	Swing angle	85° left and right (automatic) 15° up and down (manual)

■ The above specification may be changed without further notice.

Panasonic Corporation

Web site: <http://www.panasonic.com>

© Panasonic Corporation 2025

Issue date: 01/2025
P0125-0 19GNH4500 H