

# Technical Specifications

## 技術規格



Model / 型號	NA-F60A7P	NA-F60A7
Rated Voltage / 定額電壓	220 V	220 V
Rated Frequency / 定額電源頻率	50 Hz	50 Hz
Washing Capacity / 洗滌容量	6.0 kg	6.0 kg
Spinning Capacity / 脫水容量	6.0 kg	6.0 kg
Energy Consumption / 耗電量	96 Wh	96 Wh
Water Consumption / 耗水量	96 L	96 L
Outside Dimensions / 外形尺寸 (Width×Depth×Height/寬度×深度×高度)	525 mm×561 mm×923 mm	525 mm×561 mm×923 mm(不含排水管尺寸)
Uncrated Weight / 淨重	Approx.32 kg/約32 kg	Approx.31 kg/約31 kg
Pressure of tap water / 水龍頭水壓	0.03 - 1 MPa	

\* Specifications subject to change without notice.      \* 如有技術變動，恕不另行通知。

### MEMO

---

---

---

---

---

---

---

---

---

---

---

---

---

---

---

---

---

---

---

---

---

---

---

---

# Operating Instructions 使用說明書

Fully Automatic Washer  
(Domestic use)  
全自動洗衣機  
(家用)

Model No.  
**NA-F60A7P NA-F60A7**

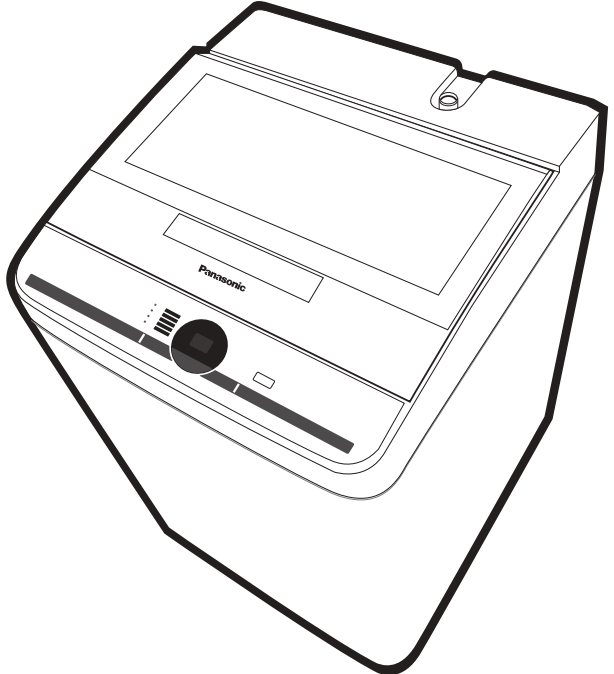

Thank you very much for purchasing **Panasonic** product.  
非常感謝您購買了Panasonic產品。

- Before operating this washing machine, please read these instructions carefully and completely, paying special attentions to notes pertaining to your particular model.  
在使用此洗衣機前，請仔細閱讀全本使用說明書，並留心有關型號的注意事項。

Panasonic Corporation  
Web Site: <http://www.panasonic.com>



AWW9901B12B0-0B0  
中國印刷發行：2019年2月

# CONTENTS

# 目錄

## Read this before using this product 使用前須知

• Safety Precautions .....	3	• 安全注意事項 .....	3
• Names of Parts .....	5	• 部件名稱 .....	5
• Operations .....	6	• 操作 .....	6
• How to install .....	8	• 安裝方法 .....	8
• Procedures before Washing .....	11	• 洗衣前的準備 .....	11

## Quick Reference 簡易使用

• Normal Course .....	12	• 標準程序 .....	12
• Soak Course .....	13	• 高濃度浸洗程序 .....	13
• Speedy Course .....	14	• 超快速程序 .....	14
• Quick Hanging Course .....	15	• 快速晾衣程序 .....	15
• Delicate Course .....	16	• 纖細衣物程序 .....	16
• Blanket Course .....	17	• 被氈程序 .....	17
• Tub Clean Course .....	18	• 除菌淨桶程序 .....	18
• Air Dry Course .....	19	• 衣物風乾程序 .....	19

## Advanced Functions 進階功能

• Washing with the Programmable Timer .....	20	• 使用預約時間的洗滌方法 .....	20
• Custom Washing .....	22	• 自設洗滌 .....	22
• Cancel End-of Cycle Buzzer .....	22	• 取消洗滌結束時的蜂鳴音 .....	22
• Change of Course .....	23	• 程序的轉換 .....	23
• Child Lock Mode .....	24	• 兒童安全鎖 .....	24
• Clever Laundering (Softener/Bleach) .....	25	• 靈巧的洗滌加工 (柔順劑/漂白劑) .....	25
• Laundry Tips .....	26	• 洗滌方法的幾項建議 .....	26

## If Necessary 如果需要時

• Maintenance .....	27	• 保養 .....	27
• Troubleshooting		• 故障維修	
• Check the following before request service .....	29	• 報修前檢查以下項目 .....	29
• If indications appear as such on the display panel .....	31	• 顯示屏如果出現下列顯示時 .....	31
• Technical Specifications .....	Back cover	• 技術規格 .....	封底

# Safety Precautions (Please follow strictly)

## 安全注意事項 (請務必遵守)

To prevent the risk of danger to humans or property damages, make sure to follow the precautions described below. 爲了防止造成人身傷害或財產損壞，其必須遵守的事項說明如下。

■ Ignorance and misunderstanding of items might result in the following consequence. ■ 忽視或錯誤理解這些事項，會產生下列兩種後果。

 <b>WARNING 警告</b>	There is a risk of serious personal injuries. 可能造成較嚴重的人身傷害。
---	---

 <b>CAUTION 注意</b>	There is a risk of personal injuries or object damage. 可能造成人身傷害或物品損害。
---	---

■ The items which need to be followed are differentiated and explained according to the following mark. ■ 要求遵守的事項，按下列圖示區分並說明。

 This mark indicates the prohibited matters. 這樣的符號，指的是禁止做的事項。
--

 This mark indicates the compulsory matters to be carried out. 這樣的符號，指的是必須實行的事項。
---

## WARNING 警告

### For power plug and cord 關於電源插頭和電源線

- Do not damage, modify, immoderately bend, twist, pull, or bundle them. Do not put them close to heating appliance. Do not put anything heavy on them. 不要損傷、改造、過度彎曲、扭曲、拉扯或捆扎電源線，請勿靠近熱源，不要用重物壓。
- Do not connect / disconnect them with wet hand. 不要用濕手插拔電源插頭。
- Do not hold the cord when pulling out of the socket. 不要拉著電源線從電源插座拔出。
- Do not use a damaged cord or power plug. Also do not use them when the socket is loose. 不要使用損壞的電源插頭或電源線，電源插座有鬆動時，不要使用它們。
- If the power cord is damaged, it must be replaced by the manufacturer, its service agent or similarly qualified persons in order to avoid a hazard. 如果電源線損壞，爲避免出現危險，必須由製造商、其維修代理或具有相關資格的人員進行更換。

### For tub and main unit 對洗衣槽和本體

- Do not allow children to use alone. This appliance is not intended for use by persons (including children) with reduced physical, sensory or mental capabilities, or lack of experience and knowledge, unless they have been given supervision or instruction concerning use of the appliance by a person responsible for their safety. 本電器用品並非設計給身體、感覺或心智功能不足者(包括孩童)、或缺乏經驗及知識者使用，除非有能確保其安全者給予監督或指導，才能使用本產品。
- Children should be supervised to ensure that they do not play with the appliance. 應避免讓孩童嬉玩本產品。
- Do not disassemble, repair or remodel this washing machine. (To prevent fire or abnormal operation, resulting in injury.) 切勿拆卸、維修或改造。(否則可能引起火災，或出現異常情況致傷。)
- Keep away from the fire. (There is a danger of fire or deformation.) 請勿靠近點著的蠟燭、蚊香以及香煙等火源。(否則可能引起火災或機器變形。)
- Do not touch the tub until it completely stops. (Your finger may be entangled in the laundry even during slow rotation, resulting in injury.) 洗衣槽完全停止旋轉前，切勿觸碰。(即使洗衣槽旋轉緩慢，也可能使衣物纏在手上而引致受傷。)

# ⚠ WARNING 警告

## For power plug and cord 關於電源插頭和電源線

- Use a rated AC 220 V, current 5 A single-phase poles with ground socket separately.
- 請單獨使用額定交流220 V, 電流在5 A以上的單相兩極帶接地電源插座。



- Insert the power plug completely into the socket.
- 電源插頭確保插到底。



- Wipe the plug periodically with dry cloth. (Accumulated dust collects moisture, which may cause insulation failure, resulting in fire.)
- 定期用乾布清除電源插座上的灰塵。(積聚的灰塵會吸收濕氣, 導致絕緣失效, 引起火災)



- Pull out the power plug before cleaning or after the operation.
- 在清潔之前或每次用完之後, 請拔掉電源插頭。



- In case of emergency or operation failure, stop using the washing machine immediately and pull out the power plug. (To prevent fume, fire or electric shock.)

- 發生緊急事件或操作失敗, 立即停止使用洗衣機並拔出電源插頭。(為了避免冒煙、起火或觸電。)



- No operation even power is on, accumulated dust and moisture on the power plug.
- Abnormal sound in operation, burnt odor etc. → Consult a service person for inspection and repair immediately.

- 接通電源, 洗衣機仍無法起動, 電源插頭上積累了灰塵和水垢。
- 洗衣機運轉時有異音、焦臭味等。→ 立即聯繫專業的服務人員進行檢查和維修。

## During use 使用時

- Do not splash water over the washing machine.
- Do not install the washing machine in a damp place or a place which may be exposed to rain, water etc. (To prevent electric shock or fire.)



- 不要在洗衣機上淋水。
- 不要把洗衣機安置在浴室、陽臺等潮濕處或風吹雨淋處。(為了避免觸電或火災。)

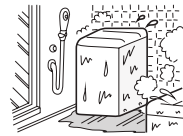

- Do not place flammable substances near the machine, such as kerosene, benzene, paint thinner and alcohol. Do not put clothing with such substances in the tub. (There is a risk of explosion or fire.)



- 請勿將易燃物如煤油、汽油、油漆稀釋劑和酒精放置在洗衣機附近。請勿將沾有上述物質的衣物放入洗衣機內。(否則可能引起爆炸或火災。)



- Keep away magnetic objects such as magnet from the operation panel. (The tub may operate even with the lid open, resulting in injury.)



- 不要把磁鐵或帶有磁性的物品放在洗衣機操作部附近。(可能使機蓋在打開的狀態時, 脫水桶也持續運轉, 造成受傷。)

- If the tub does not stop with 15 seconds when the lid is open during spin cycle, switch off the washing machine immediately and call a service person.



- 如果在機蓋打開后15秒後洗衣槽仍未停止轉動, 請立即關閉洗衣機並聯繫服務人員進行檢查和維修。

# ⚠ CAUTION 注意

- Do not use water hotter than 50 °C for washing. (The plastic parts will become deformed, resulting in electric shock or electricity leakage.)
- Do not connect to the hot water supply.
- 請勿使用50 °C以上的熱水洗滌衣物。(否則塑料部件將會變形, 導致電擊或漏電事故。)
- 不要連接熱水水源。



- Install the washing machine on a sturdy floor of which maximum permissible inclination is two degrees.
- Do not obstruct the openings of the bottom face with carpet, etc.
- 將洗衣機安裝在平穩的地面上, 地面傾斜角度不可超過2度。
- 請勿讓地毯等物品阻礙底面開口。

- Do not wash and spin waterproof sheets and garments. (Example) Raincoats, outfits (coats/jackets and pants) for fishing and skiing, etc.

The items could be damaged or you could be injured due to irregular vibration during the spin cycle.



- 請勿洗滌防水性布料和衣物, 或對其進行脫水。(例如) 雨衣、釣魚和滑雪用衣(大衣/外衣和褲子)等。
- 此類物品可能會受到損傷, 或在脫水過程中出現異常震動而使您受傷。



# Names of Parts

## 部件名稱

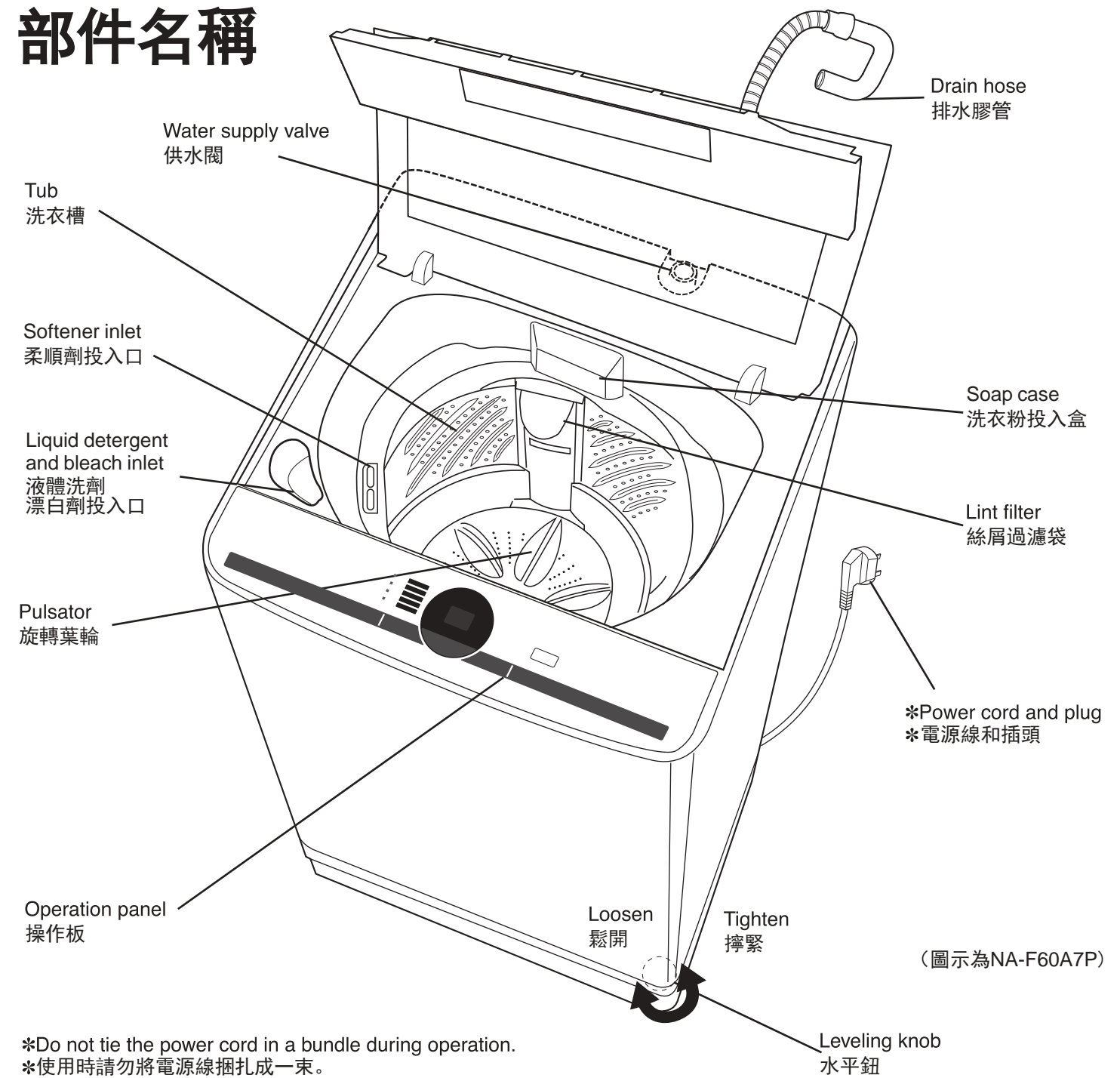

(圖示為NA-F60A7P)

- \*Do not tie the power cord in a bundle during operation.
- \*使用時請勿將電源線捆扎成一束。

## Accessories 附件

Water supply hose(1) 供水膠管(1根)	Drain hose (1) Hose Band (1) Hose Supporter (1) Screw (1)	排水膠管(1根) 膠管的固定環(1個) 膠管固定片(1個) 螺釘(1個)	Drain hose (1) Hose Band (1) 排水膠管(1根) 膠管的固定環(1個)	Bottom plate(1) 底板(1塊)	Water tap adapter(1) 水龍頭轉接器(1個)
	(NA-F60A7P)	(NA-F60A7)	(NA-F60A7)	Screw(5) 螺釘(5個)	Screw(1) 螺釘(1個)



# Operations 操作

## Indicators 顯示部位

### Progress Indicator 過程指示燈

- Indicates the cycle in progress by flashing.
- 閃爍表示正在進行的步驟。

### Water level Indicator 水位顯示燈

- The water level which has been selected will be displayed in the right side window.
- 所選水位會在右側窗口顯示。

### Display window 顯示部

- After the course starts, the time left will be displayed as a guide.
- \* The time left display may differ from the actual time depending on the type of washing and the setup conditions.
- If the time has been set, the amount of time remaining will be displayed.
- Indicates the code which course has been selected.
- Indicates the appropriate water level according to the laundry amount.
- 開始後，顯示剩餘時間的估計值。
- \*根據洗滌物的種類和設置狀態，顯示的剩餘時間可能與實際不同。
- 預約時，顯示幾小時後洗滌完畢。
- 顯示所選擇的程序的代碼。
- 根據衣物量顯示相應的水位。

### Course Indicator 程序指示燈

- The code which course has been selected will be displayed in the left side window.
- 所選程序代碼會在左側窗口顯示。

(NA-F60A7P)

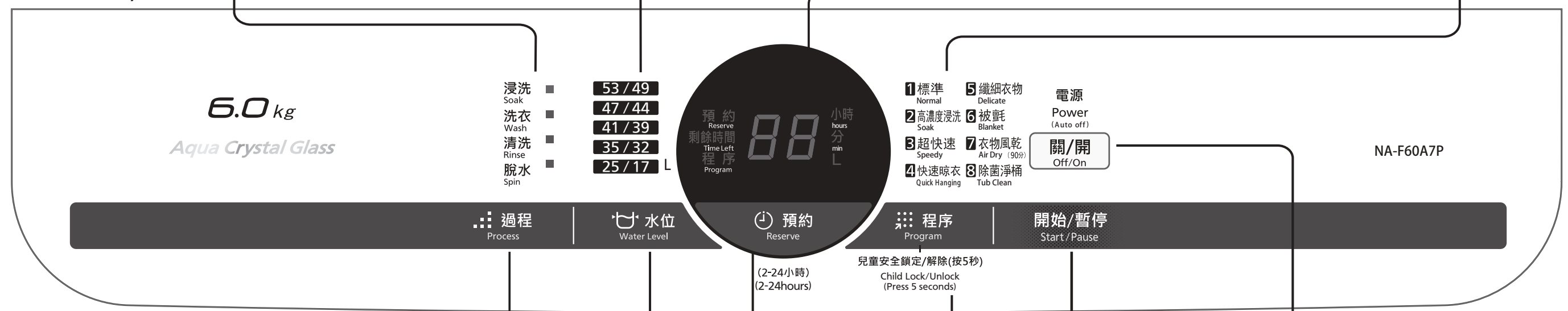

## Buttons 按鈕部位

### Process 過程

- Custom cycles can be chosen. See page 21 for details.
- 可選擇單一的步驟。詳細情況請參照第21頁。

### Water level 水位

- Setting can be changed according to your preference.
- 可根據需要進行切換。

### Reserve 預約

- Select how many hours from now you would like operation to stop.
- 選擇從現在開始幾小時後停止運轉。

### Course Selection 程序選擇

- According to laundry volume and stain, you can select a suitable course by yourself.
- 根據衣物量和髒污程度，您可以選擇合適的程序。

### Start/Pause 開始/暫停

- Push this button to start.
- Push this button to stop mid-cycle.
- 按該鈕可開始洗衣。
- 按該鈕可使洗衣過程暫停。

### Power Switch 電源開關

- The power automatically turns off when a function cycle is finished.
- The power automatically turns off if washing is not begun within 10 minutes after turning the power on.
- The buzzer sounds when the power switch is turned off.
- 一個功能步驟完成時，電源會自動關閉。
- 如果在打開電源後10分鐘內沒有開始洗衣，電源將自動關閉。
- 關閉電源開關時，會發出蜂鳴音。

**Attention** Turn the power OFF and ON again to change the course or the preferences after the wash cycle.

**注意** 要改變行程以及洗衣以後的內容，請重新打開電源。

# How to Install

## See the Installation Manual for details.

# 安裝方法

詳細情況請查閱安裝說明書。

■If the installation method, operation and check are not followed to instruction, our company will not be responsible for accident or damage caused.  
 ■未按本安裝方法設置、運行、點檢引起的事故、損害，本公司概不負責。

### How to install the bottom plate 底板的安裝方法

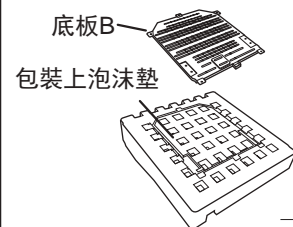

**1** Remove the bottom plate adhered on the side cushion of the washing machine.

取下包裝上泡沫墊上的底板。

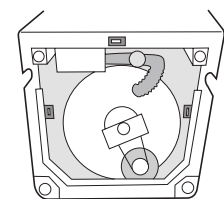

**2** Turn the washing machine over so that its front side is down.

使洗衣機前面朝下傾倒。

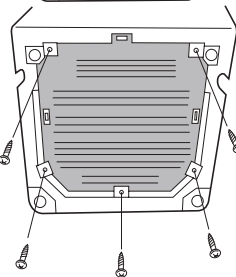

**3** Align the bottom plate with the tabs of the outer edge of the frame(3 tabs) and install by fastening screws at 5 locations. (Only for NA-F60A7P)

使底板與洗衣機框的外緣的突出部分(三處)在一條線上，然後擰緊5個螺釘將其固定。(只適用於NA-F60A7P)

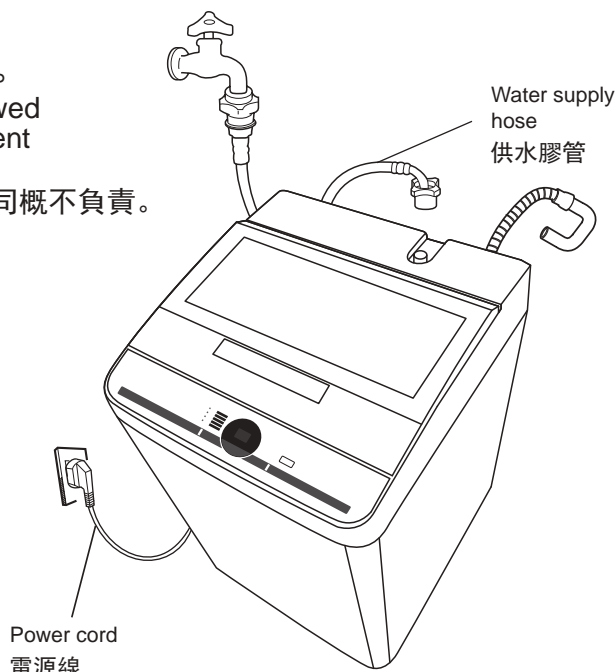

Install the bottom plate by fastening screws at 1 location. (Only for NA-F60A7)

裝好底板，然後擰緊1個螺釘將其固定。(只適用於NA-F60A7)

\*Please make sure the bottom plate is well mounted. 請確保底板安裝妥當。

### To connect the water supply hose 連接供水膠管

**1** Loosen screws on the adapter and take down the adapter.

扭鬆轉接器上的螺絲，取下轉接器。

**2** Fix the water tap adapter, with the gasket, to the water tap.

將水龍頭轉接器，連同墊片，一同扭緊於水龍頭出水位置。

Note

注意

• After installation, make sure the fixing screws are tight.

• 安裝完畢後，請確認固定螺絲已擰緊。

Note

注意

• If the fixing screws are too tight, it may cause damage of washers and lead to water leakage.

• 如果固定螺絲擰得過緊的話，可能會導致墊圈受損，引起漏水。

**3** Connect the water supply hose

連接供水膠管

Please confirm the other end of the water supply hose has been connected to the joint of the washing machine before conducting the following operations:

進行下列操作前請先確認供水膠管的另一側已和洗衣機的供水閥相連接。

- 1) Connect the water supply hose and water tap adapter or the water tap.
- 2) Turn on the handle of the water tap after connecting the water supply hose.
- 3) Please confirm carefully whether there is water leakage at the water tap and each connecting point after the installation is completed.
- 4) New hose-sets supplied with the appliance are to be used and old hose-sets should not be reused.

- 1) 將供水膠管和水龍頭的出水口相連接。
- 2) 供水膠管連接完畢後，打開水龍頭的開關。
- 3) 安裝操作完畢後，請仔細確認水龍頭及各安裝部位有否漏水。
- 4) 請務必使用附帶的新供水膠管，舊供水膠管不能重複使用。

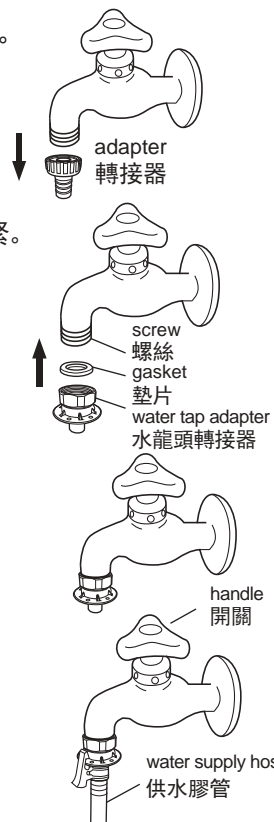

### (NA-F60A7P)

### To connect External Drain Hose

- Connect the drain hose securely to the main body of the washer, ensure that hose rib and base side are secured, and move the hose band next to the washer body.
- 將排水膠管牢靠地連接至洗衣機本體上，確保膠管的凸筋與底座面完全嵌入，並將膠管固定環移至洗衣機邊上。

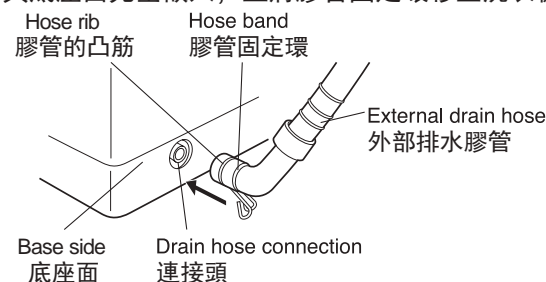

### Note 注意

- To avoid direct draining due to the fallen water drain hose, the water drain hose must be used only after installing into fixing holder and its hanging height should not exceed 1 m.
- Do not release the water drain hose lest the water is splashed.
- Do not use extended water drain hose.
- Do not immerse the U-shaped hose which is on the tail of the drain hose in the water.
- Be sure not to install the drain hose at a position lower than drain hose connection, otherwise, it could lead to difficulties in drainage.
- 爲了避免排水膠管掉落造成直接排水，請務必將排水膠管嵌入膠管固定片後再進行使用，且排水膠管的掛靠高度不應超過1米。
- 請勿將排水膠管放倒，以免水灑落。
- 請勿使用延長排水膠管。
- 請勿將排水膠管尾部的U型管浸沒在水中。
- 排水膠管安裝時，請勿低於連接頭，如低於連接頭可能會導致排水不暢。

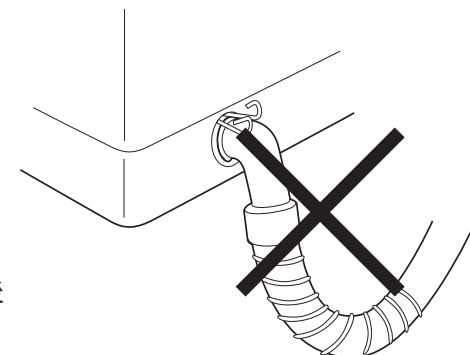

Connect the water supply hose to the water supply valve screw.

將供水膠管與供水閥螺口連接。

**1** Push the water supply hose nut straight onto the water supply valve screw.

將供水膠管螺母垂直地頂在供水閥螺口上。

**2** Hold the elbow by lifting it up, screw the nut onto the water supply valve screw, and firmly tighten the nut.

向上托住彎管，將螺母擰緊在供水閥螺口上。

**3** After the nut is tightened, check whether or not the elbow is unsteady or loose.

擰緊螺母後，確認彎管是否不穩或鬆動。

**4** After tightening, open the faucet to confirm that there is no water leakage.

擰緊後，打開水龍頭開關，確認是否有漏水。

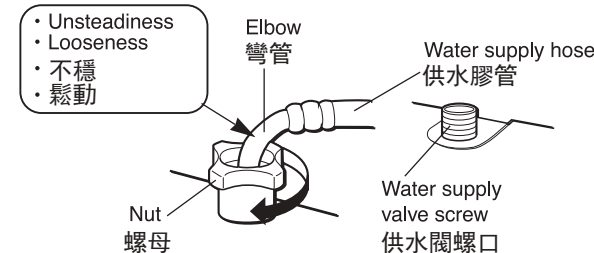

Firmly tighten the nut. Otherwise, it will result in water leakage.

請擰緊螺母。否則會漏水。

### 外部排水膠管連接方法

- Connect the drain hose to the drain hose connection of the machine. Fasten the drain hose on the rear side of body as shown by hose supporter supplied with the machine.
- 將排水膠管連接至本機的连接頭。如圖所示，用本機附帶的膠管固定片將排水膠管固定在機體背後。

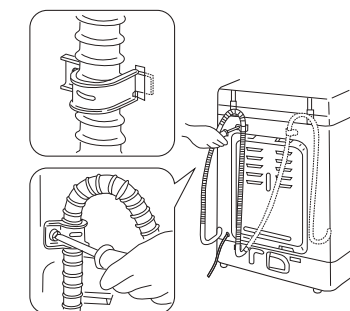



■ To connect external drain hose.  
外部排水膠管連接方法。

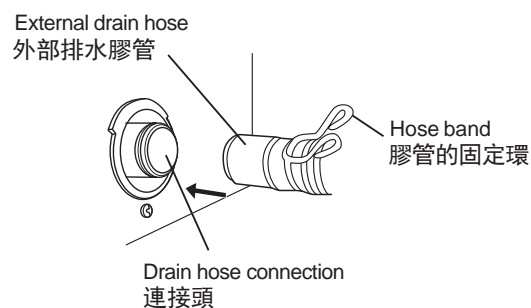

1 Connect the drain hose securely to the main body of the washer.  
將排水膠管牢靠地連接至洗衣機本體上。

(請確認膠管不會脫落，否則有漏水的可能。)

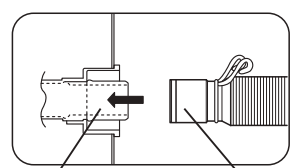

Drain hose connection 連接頭 External drain hose 外部排水膠管

2 Move the hose band next to the washer body.  
將膠管的固定環移至洗衣機邊上。

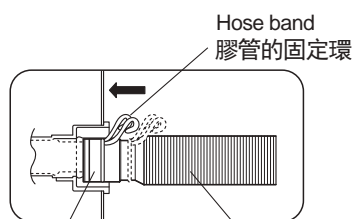

Drain hose connection 連接頭 External drain hose 外部排水膠管

- \* Make sure to remount the back panel after changing the position of the drain hose.
- \* When the external drain hose is difficult to install, please coat with washing liquid in the inside of the hose.

■ Changing the drain hose to the opposite side (left).

將排水軟管移至相反一側(左側)。

1 Remove the back panel.  
拆除後蓋板。

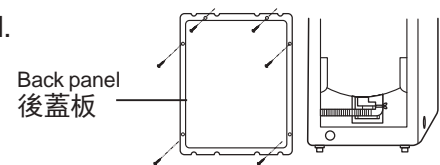

2 Remove the left hose hole cover.  
拆除左側的孔蓋。

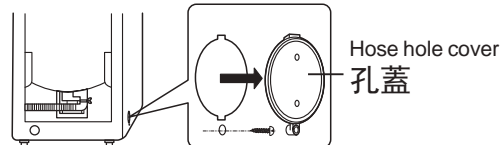

3 Clench the two claws at the right side of drain hose's outfall, push it inside the washing machine, remove the drain hose. Then insert the drain hose's outfall into the left base hole from the inside of washing machine keeping the alignment pin down. And gently pull the drain hose from the inside of washing machine, make sure the two claws lock into the base hole.

捏緊右側排水軟管的排水口處兩個卡爪，推向洗衣機內部，取下排水軟管。然後將排水軟管的排水口定位銷朝下，從洗衣機內部插入底座左側孔，並從洗衣機內部輕拉排水軟管，確認兩個卡爪完全卡入。

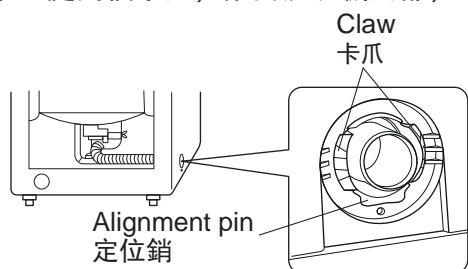

4 Install the hose hole cover to the right hose hole, and fasten with the screw.  
將孔蓋裝到右側並用螺釘固定。

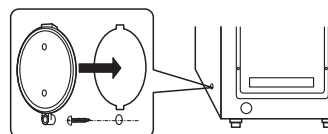

5 Install the back panel, and fasten with the screw.  
裝好後蓋板並用螺釘固定。

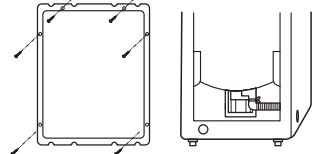

- \* 在變更排水軟管位置以後，務須安裝好後蓋板。
- \* 外部排水膠管不容易裝入時，請在膠管的內側塗上洗滌液。

■ If extended external part is necessary when connecting the drain hose

- The length of the drain hose should be less than 3 m and the height below 10 cm. Otherwise the machine will stop running while in operation.
- Be sure the distance between the machine and the wall is above 5 cm.

如要延長外部排水膠管，連接排水膠管時

- 其長度應在3 m以內，高度在10 cm以下，若太長或太高，運轉途中會停機。
- 本機與牆壁之間應保留5 cm以上的空間。

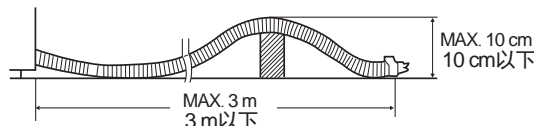

# Procedures before Washing 洗衣前的準備

## • Check the installation

See page 8 for details.

- 1 Attach the drain hose to drain.
- 2 Connect the water supply hose.
- 3 Turn on the water faucet.

Note

- Be sure to close the water faucet after the operation.

4 Plug the cord into outlet.

- Be sure to pull the power plug out of the outlet after the operation.

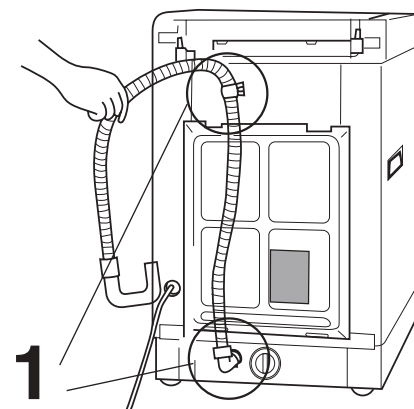

(Only for NA-F60A7P)  
(只適用於NA-F60A7P)

## • 確認安裝狀況

詳細情況請參照第8頁。

- 1 接好排水膠管使其處於排水狀態。
- 2 連接供水膠管。
- 3 打開水龍頭。

注意

- 使用完畢後請確認關閉水龍頭。

4 將插頭插入插座。

- 使用完畢後請確認將電源插頭從插座中拔出。

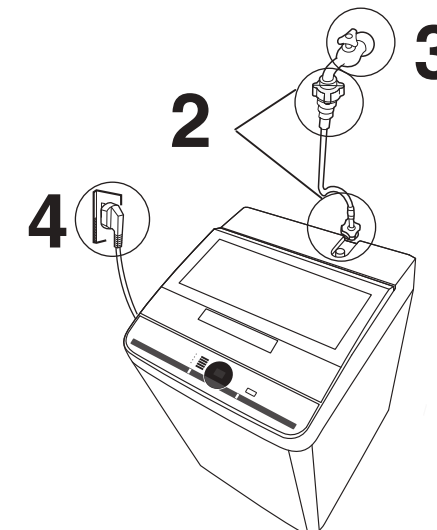

## ■ Detection of the amount of laundry

1 Put the laundry into the machine.  
放入衣物。  
Press the power OFF/ON button and then press the START button after putting in the laundry.  
放入衣物後，按電源“關/開”和開始鈕。



2 Allow the machine to churn the laundry for 8 seconds.  
洗衣機攪拌衣物約8秒。  
The pulsator rotates for about 8 seconds without any water in the tub to measure the amount of laundry.  
洗衣槽在無水的情況下，旋轉葉輪約8秒來檢測衣物量。



## ■ 衣物量檢測

3 Water level is indicated.  
顯示水位。  
It will indicate the appropriate water level (except 17L). Add the indicated amount of detergent.  
顯示與現有衣物量相應的水位(17L除外)。根據顯示加入洗滌劑。



水位 Water Level

- Attention In "SPEEDY" Course, "DELICATE" Course and "BLANKET" Course, the laundry load is not measured.
- 注意 “超快速”程序，“纖細衣物”和“被氈”程序不進行衣物量檢測。

- When washing laundry's lint gets off easily, please raise the water level to advance the rinsing effect.
- 洗滌容易脫落線屑的衣物時，請適當提高水位高度，以提升漂洗效果。

# Normal Course 標準程序

(NA-F60A7P)

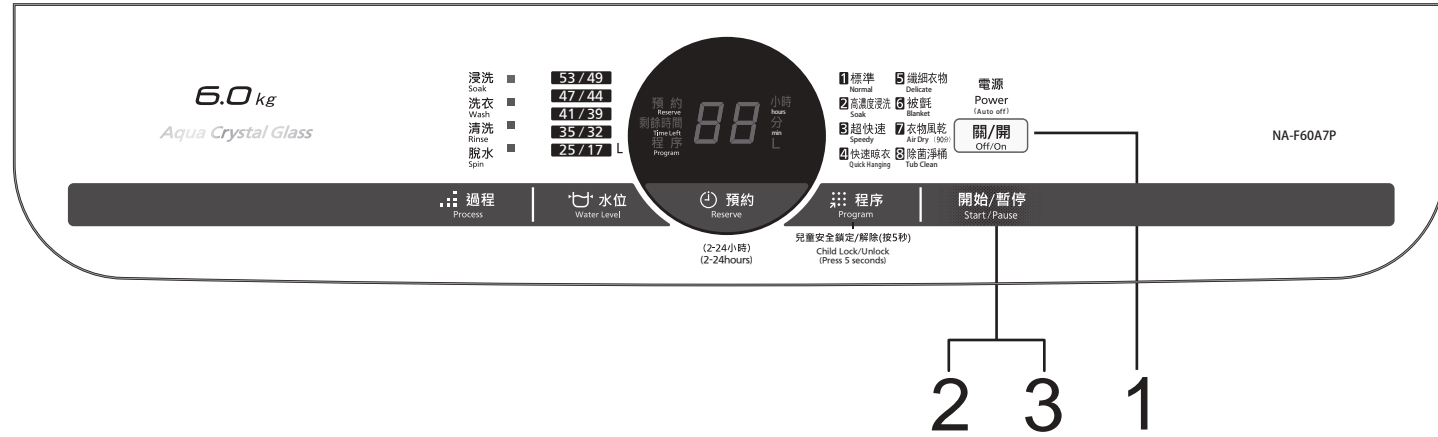

**1** Put the laundry in, and press the power OFF/ON button.

放入衣物，按下電源“關/開”鈕。

**2** Press the START/PAUSE button. Measuring the amount of laundry.

按下“開始/暫停”鈕，檢測衣物量。

**3** Put in appropriate amount of detergent according to the water level. Then, close the lid.

加入與水位相應的洗滌劑，關上洗衣機蓋。

When the buzzer sounds, washing is finished.

蜂鳴音響起時，洗滌完成。

## What is the “NORMAL” Course? 什麼是“標準”程序?

- Suitable for washing casual wear. • 適合洗滌休閒服裝。

■ The machine will measure the laundry load by churning the laundry without any water, and display the water level. ■ 在無水狀態下，洗衣機攪拌衣物以檢測衣物量，並顯示相應的水位。

■ Some detergents have their own prescribed methods of use. Please read the instructions of your detergents. ■ 某些洗滌劑有特定的使用方法。請閱讀使用說明書。

■ Adding softener. See page 25 for details. ■ 加入柔順劑。詳細情況請參照第25頁。

# Soak Course 高濃度浸洗程序

(NA-F60A7P)

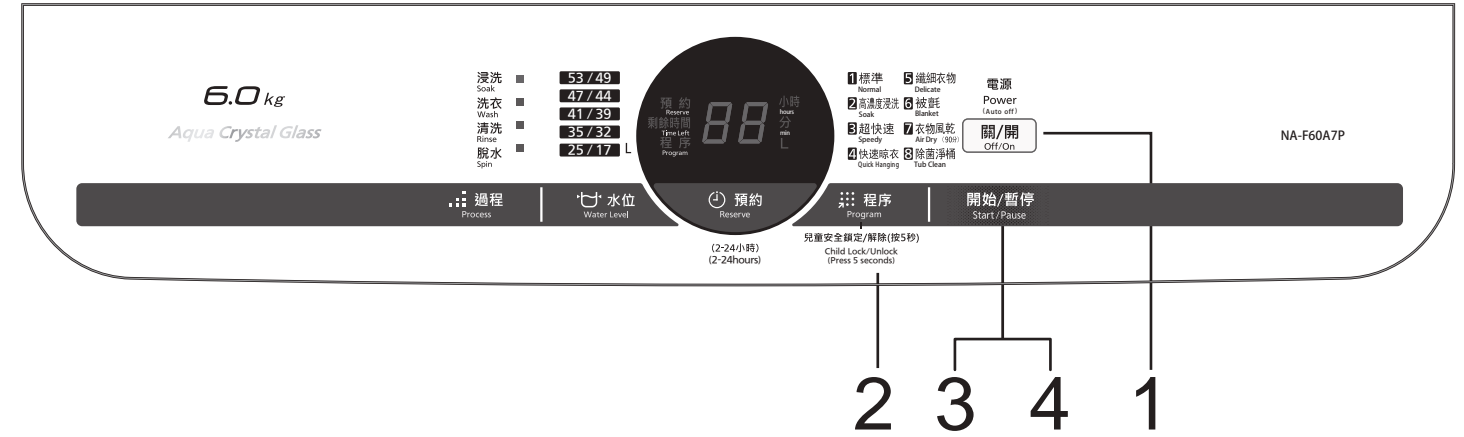

**1** Put the laundry in, and press the power OFF/ON button.

放入衣物，按下電源“關/開”鈕。

**2** Press the PROGRAM button to select the SOAK course.

按程序鈕選擇“高濃度浸洗”程序。

**3** Press the START/PAUSE button. Measuring the amount of laundry.

按下“開始/暫停”鈕，檢測衣物量。

**4** Put in appropriate amount of detergent according to the water level. Then, close the lid.

加入與水位相應的洗滌劑，關上洗衣機蓋。

When the buzzer sounds, washing is finished.

蜂鳴音響起時，洗滌完成。

## What is the “SOAK” course? 甚麼是“高濃度浸洗”程序?

- It is suitable for washing stained laundry and the soiled collar and wrist portions of dress shirts. • 適合洗滌有污點的衣物，以及衣領和袖口有污漬的襯衫。
- Cascades of water strike the high-density wash water, generating thick, rich foam that penetrates into fabrics and lifts away dirt and grease. • 傾瀉的瀑布水流撞擊高濃度的洗衣水，產生濃密的泡沫並滲透衣物，從而去除污垢及油脂。

■ The machine will measure the laundry load by churning the laundry without any water, and display the appropriate water level.

■ 在無水狀態下，洗衣機攪拌衣物以檢測衣物量，並顯示相應的水位。

# Speedy Course 超快速程序

(NA-F60A7P)

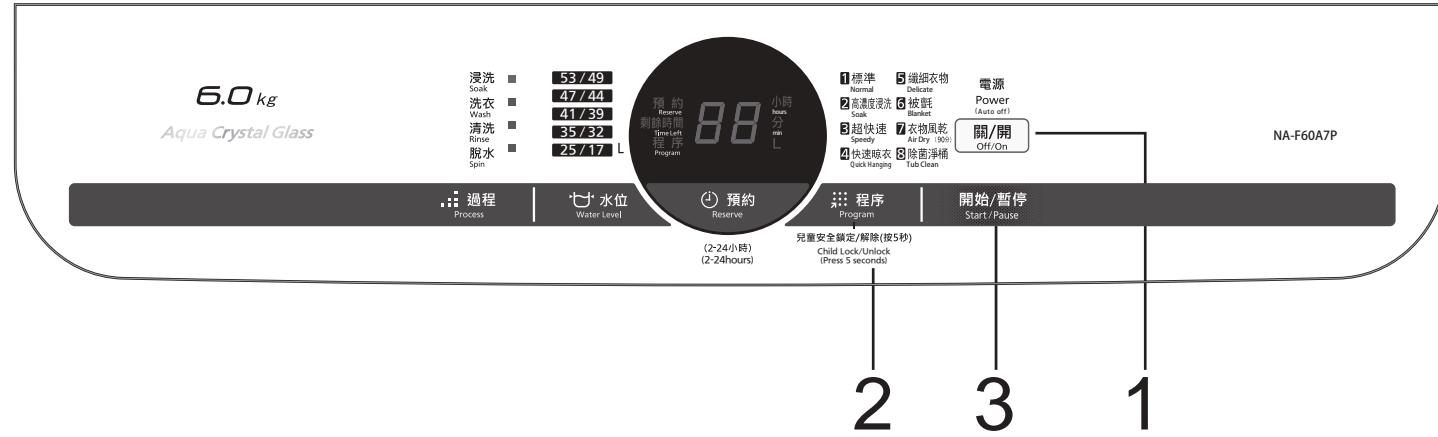

**1** Put the laundry in, and press the power OFF/ON button.

放入衣物，按下電源“關/開”鈕。

**2** Press the PROGRAM button to select the SPEEDY course.

按程序鈕選擇“超快速”程序。

**3** Put in appropriate amount of detergent according to the water level. Close the lid and then press the START/PAUSE button.

加入與水位相應的洗滌劑，關上洗衣機蓋，並按下“開始/暫停”鈕。

## What is the “SPEEDY” course? 甚麼是“超快速”程序?

- Suitable for washing slightly soiled laundry or for quick wash.
- 適合洗滌輕度髒污的衣物或進行快速洗滌。

### Amount of laundry

- Under 2.5 kg can be washed.

### The “39 L” water level is displayed.

- Water level adjusts from 17 to 39 L.

### 洗滌容量

- 可以洗滌2.5 kg以下的衣物。

### 顯示“39 L”水位。

- 17~39 L間水位可以調節。

# Quick Hanging Course 快速晾衣程序

(NA-F60A7P)

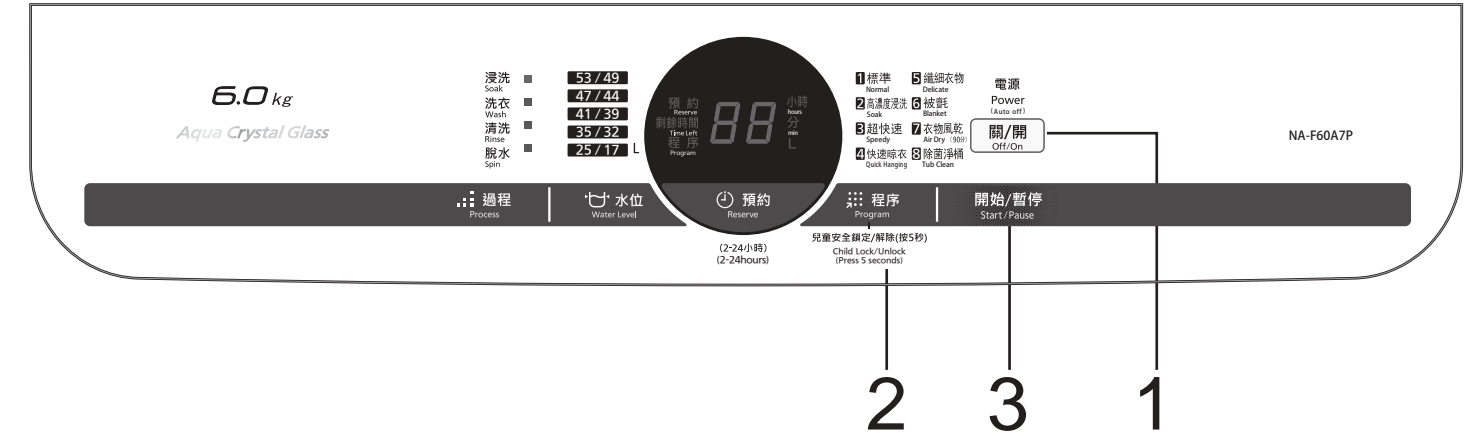

**1** Put the laundry in, and press the power OFF/ON button.

放入衣物，按下電源“關/開”鈕。

**2** Press the PROGRAM button to select the QUICK HANGING course.

按程序鈕選擇“快速晾衣”程序。

**3** Put in appropriate amount of detergent according to the water level. Close the lid and then press the START/PAUSE button.

加入與水位相應的洗滌劑，關上洗衣機蓋，並按下“開始/暫停”鈕。

## What is the “QUICK HANGING” course? 甚麼是“快速晾衣”程序?

- This course can reduce the humidity of the laundry by extending the time of spin to save the drying time.
- 通過延長脫水時間來降低衣物含水量，節省晾衣時間。

■ The machine will measure the laundry load by churning the laundry without any water, and display the water level.

■ 在無水狀態下，洗衣機攪拌衣物以檢測衣物量，並顯示相應的水位。

■ Some detergents have their own prescribed methods of use. Please read the instructions of your detergents.

■ 某些洗滌劑有特定的使用方法。請閱讀使用說明書。

■ Adding softener. See page 25 for details.

■ 加入柔順劑。詳細情況請參照第25頁。

When the buzzer sounds, washing is finished.

蜂鳴音響起時，洗滌完成。

When the buzzer sounds, washing is finished.

蜂鳴音響起時，洗滌完成。



# Delicate Course 纖細衣物程序

(NA-F60A7P)

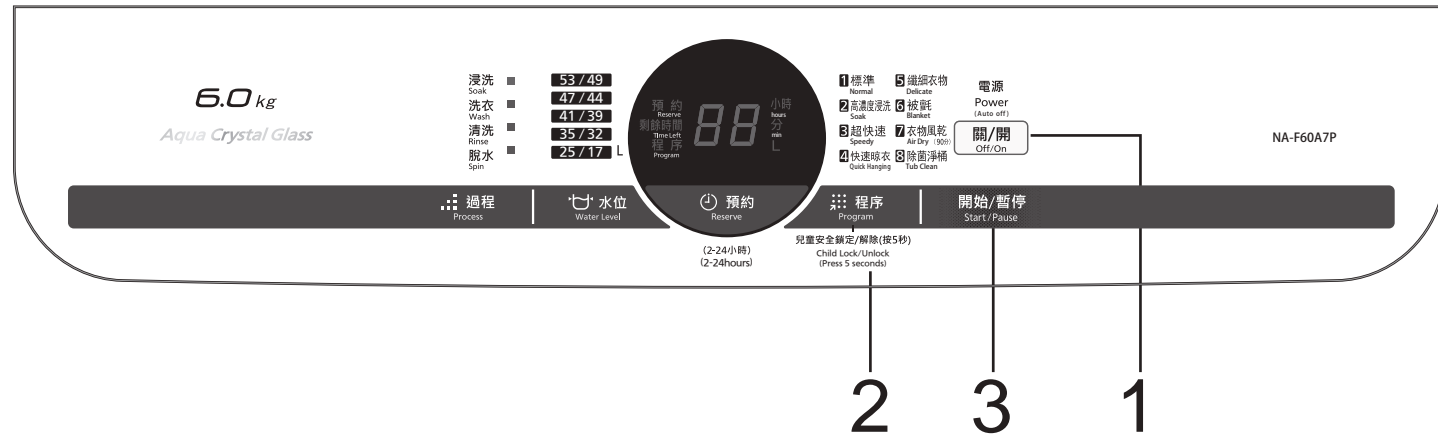

**1** Put the laundry in, and press the power OFF/ON button.

放入衣物，按下電源“關/開”鈕。

**2** Press the PROGRAM button to select the DELICATE course.

按程序鈕選擇“纖細衣物”程序。

**3** Put in appropriate amount of detergent according to the water level. Close the lid and then press the START/PAUSE button.

加入與水位相應的洗滌劑，關上洗衣機蓋，並按下“開始/暫停”鈕。

When the buzzer sounds, washing is finished.

蜂鳴音響起時，洗滌完成。

## What is the “DELICATE” course? 甚麼是“纖細衣物”程序?

- It is good for washing wool items. 適合洗滌毛衣或纖細衣物之類。
- The “39 L” water level is displayed. 顯示“39 L”水位。
- Water level adjusts from 39 to 49 L. 39~49 L間水位可以調節。
- Amount of laundry** 洗滌容量
  - Under 1.2 kg can be washed. 可以洗滌1.2 kg以下的衣物。

### Washable items 可以洗滌的衣物

- 100% wool and knit wool blends
- 100%的毛衣和針織混紡毛衣



### How to wash 怎樣洗滌

- For wool and knit washes use water at about 30 °C.
- Follow the directions on the label for detergent and dissolve it well.
- Soak the laundry thoroughly in the water.
- 毛衣和針織品洗滌用水約為30°C。
- 依洗滌劑上的說明將其溶解。
- 將衣物完全浸入水中。

# Blanket Course 被氈程序

(NA-F60A7P)

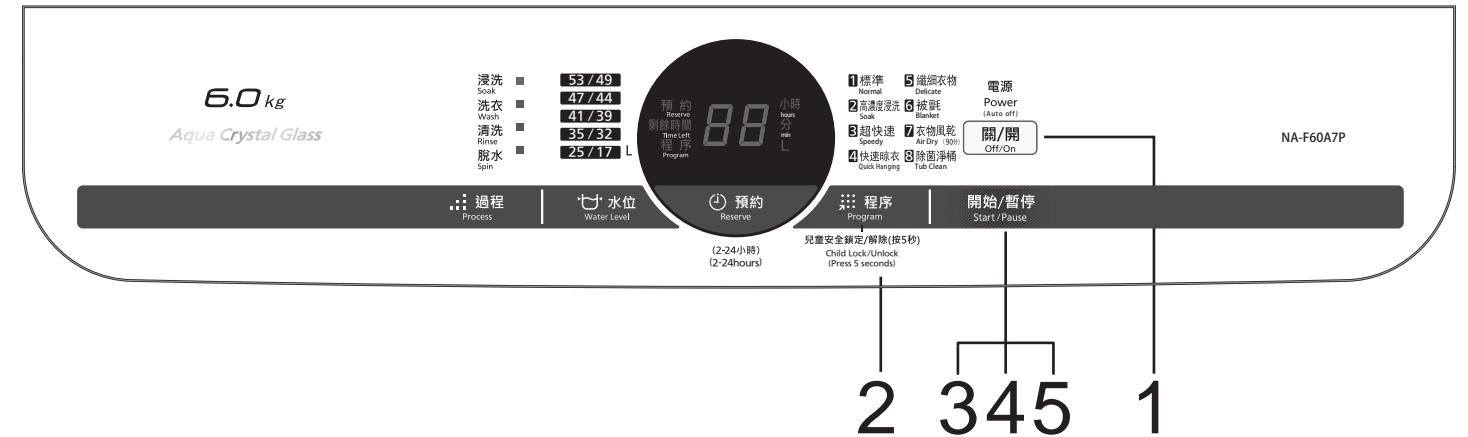

**1** Put the laundry in, and press the power OFF/ON button.

放入衣物，按下電源“關/開”鈕。

**2** Press the PROGRAM button to select the BLANKET course.

按程序鈕選擇“被氈”程序。

**3** Put in appropriate amount of detergent according to the water level. Close the lid and then press the START/PAUSE button.

加入與水位相應的洗滌劑，關上洗衣機蓋，並按下“開始/暫停”鈕。

When the buzzer sounds, washing is finished.

蜂鳴音響起時，洗滌完成。

## What is the “BLANKET” course? 甚麼是“被氈”程序?

- It is suitable for washing blanket or the thick laundry. 適合洗滌毛毯或其他較厚的大件衣物。
- Amount of laundry** 洗滌容量
  - Under 2.8 kg can be washed. 可以洗滌2.8 kg以下的衣物。

### Putting bedding into the tub 毛毯的放入方法

- To fold.
  - Then Fold Screens.
  - Longitudinal fold into the M-type.
  - Putting the M-type bedding into the tub.
- Both ends of the blanket should be facing down.
  - Gently press down from above.

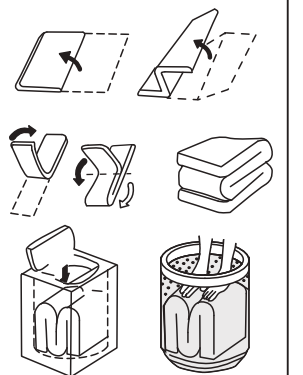

- 按長度方向對折。
  - 再折成三折(屏風折)。
  - 縱向對折，再往返折成M型。
  - 將M型的毛毯放入洗衣槽。
- 必須如圖所示將毛毯的兩端朝下。
  - 從上面輕輕往下壓一下。

### Use the following method when it is difficult to put into tub 毛毯較難放時使用以下方法

- Both ends of the blanket is aligned with the direction of the cover.
  - Put one side into the tub.
  - Put the other side into the tub.
- 把毛毯的兩端對準機蓋的方向。
  - 先把摺疊的下部放入洗衣槽內。
  - 再把另一邊放入洗衣槽內。(必須把兩端朝下)

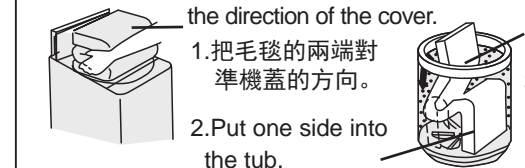

# Air Dry Course 衣物風乾程序

(NA-F60A7P)

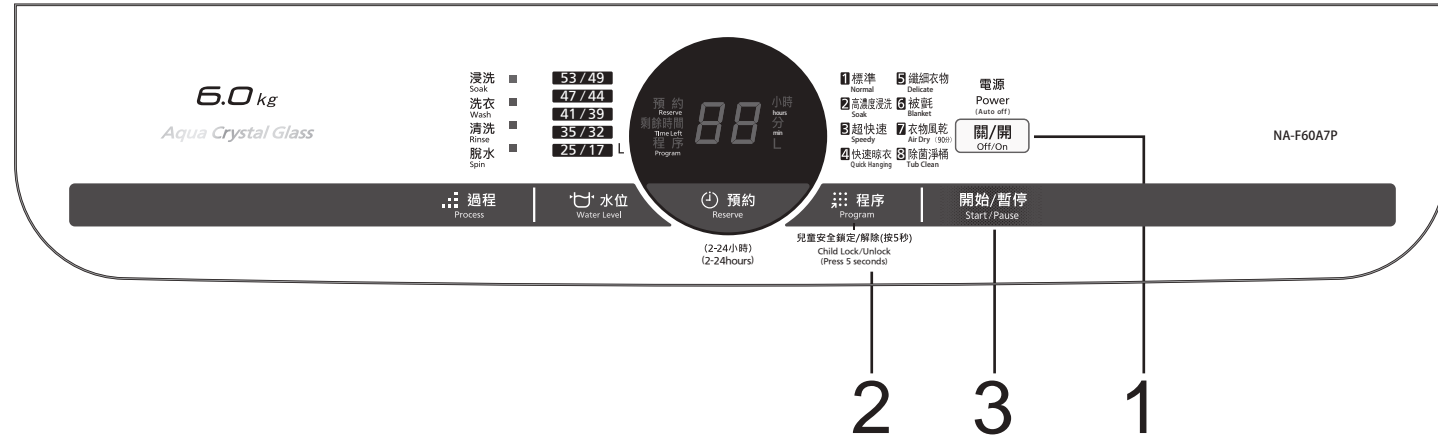

**1** Put the laundry in, and press the power OFF/ON button.  
放入衣物，按下電源“關/開”鈕。

**2** Press the PROGRAM button to select the AIR DRY course.  
按程序鈕選擇“衣物風乾”程序。

**3** Close the lid, and press the START/PAUSE button.  
關上洗衣機蓋，並按下“開始/暫停”鈕。

When the buzzer sounds, washing is finished.

蜂鳴音響起時，洗滌完成。

## What is the “AIR DRY” course? 甚麼是“衣物風乾”程序?

- Through the revolving of the wash tub and drain tub, air flow can be generated and dry the laundry.
- 利用洗衣槽回轉使空氣流動，用送風方式除去水份，從而乾燥衣物。

- Amount of laundry
- Chemical fiber clothing under 2.0kg can be dried.
- 風乾容量
- 可以風乾2.0 kg以下的化纖類衣物。

### Note:

- The wash tub and drain tub stop revolving every 30 minutes, and the pulsator revolving, which avoid the laundry convolved.
- According to the volume and kind of the laundry, temperature, humidity, surroundings, it is possible that the laundry may be not sufficiently dry. (Because heater is not used, the laundry may be cooler or not sufficiently dry.)

### 注意:

- 為避免衣物纏繞，洗衣槽大約每30分鐘停轉，同時旋轉葉輪進行一次攪拌運轉。
- 由於衣服的数量、種類、氣溫、濕度、設置環境等原因，可能會有乾燥不充分的情況。(因為是不使用發熱器的乾燥，所以會感覺衣物溫度較低或未乾燥。)

# Tub Clean Course 除菌淨桶程序

(NA-F60A7P)

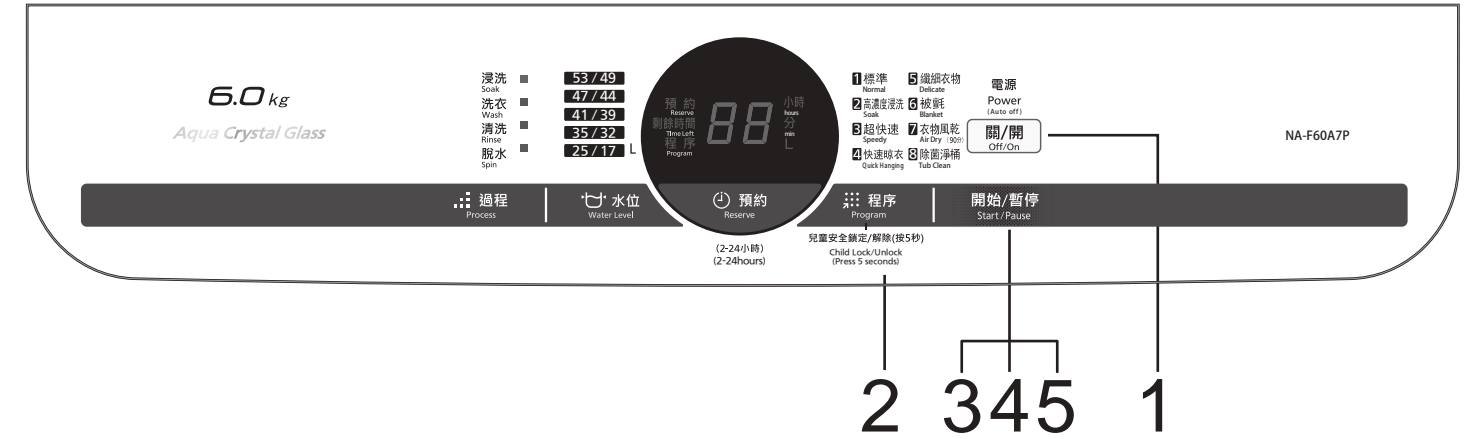

**1** Take out the laundry after the washing is finished. Press the power OFF/ON button.  
洗衣結束後，取出衣物。按下電源“關/開”鈕。

**2** Select the TUB CLEAN course.  
選擇“除菌淨桶”程序。

**3** Close the lid and press the START/PAUSE button.  
關上機蓋，按下“開始/暫停”鈕。

**4** Once the tub have filled with water, press the Pause button, and then pour approximately 200 ml of the special chlorine-based bleach for washing clothes into the tub.  
注水後，按暫停，然後將衣物專用的氯系漂白劑(約200 ml)倒入洗衣槽內。

Approx. 200 ml of chlorine-based bleach for clothes  
衣物專用氯系漂白劑約200 ml



**5** Close the lid and then press the START/PAUSE button.  
關上機蓋，按下“開始/暫停”鈕。

When the buzzer sounds, washing is finished.

蜂鳴音響起時，洗滌完成。

## What is “TUB CLEAN” course? 甚麼是“除菌淨桶”程序?

- With chlorine-based bleach (can be purchased from market), this course can help to remove mold from the wash tub and drain tub and maintains hygiene.
- 配合市面上的“衣物專用氯系漂白劑”進行淨桶程序，有效抑制洗滌、脫水槽內產生的黑黴，以保持清潔。

### Note:

- Do not use peroxide-based bleaches and bleaches designed for kitchen use. (They can cause excessive foaming which may result in overflowing.)
- Cleaning schedule :About once a month.
- Operating time will be approximately 2 hours.

### 注意:

- 請不要使用氧系漂白劑和廚房用氯系漂白劑。(產生的泡沫過多可能會溢出)
- 保養標準：每月1次左右。
- 運轉時間大約在2小時左右。

### Note:

- The amount of mold that develops in the tub will vary depending on the usage conditions.
- If mold grows in the tub, use a washing tub cleaner (sold separately) to clean the tub.

### 注意:

- 洗衣槽是否會生出黑黴，因使用環境而異。
- 附著上黑黴時，請使用另售的洗衣槽清潔劑進行洗滌。

# Washing with the Programmable Timer

## 使用預約時間的洗滌方法

### ■ Putting in laundry detergent 洗滌劑的投入方法

#### ● Concentrated-type powdered synthetic detergent 濃縮型合成洗衣粉

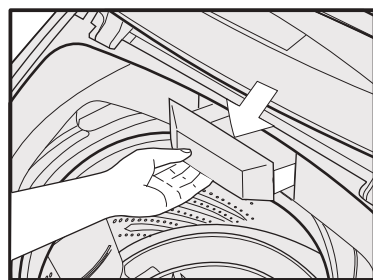

**1** Open the soap case.  
向外拉開洗衣粉投入盒。

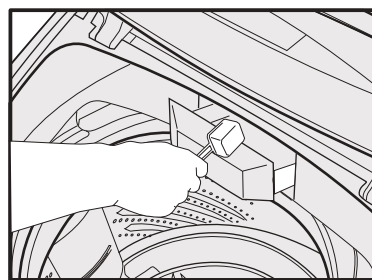

**2** Put the detergent in the soap case.  
倒入洗衣粉。

- \* If the detergent comes directly into contact with the washing (for long period), it can cause discoloration and fading, so put it in the soap case.
- \* When the detergent is caked, in order to prevent the detergent residual, please pour the detergent into the soap case after scrapping it.

- \* 在洗滌物直接接觸洗滌劑的狀態（長時間）下洗滌可能會造成染色或褪色，所以請將洗滌劑投入到投入盒內。
- \* 洗衣粉結塊時，為防止洗衣粉殘留，請敲碎後再投入。

#### ● Liquid detergent 液體洗滌劑

- As the liquid detergent has a certain degree of stickiness, please dilute it with water before pour it into the soap case.
- 由於液體洗滌劑具有一定的黏性，請先用水稀釋後，再倒入投入盒中。

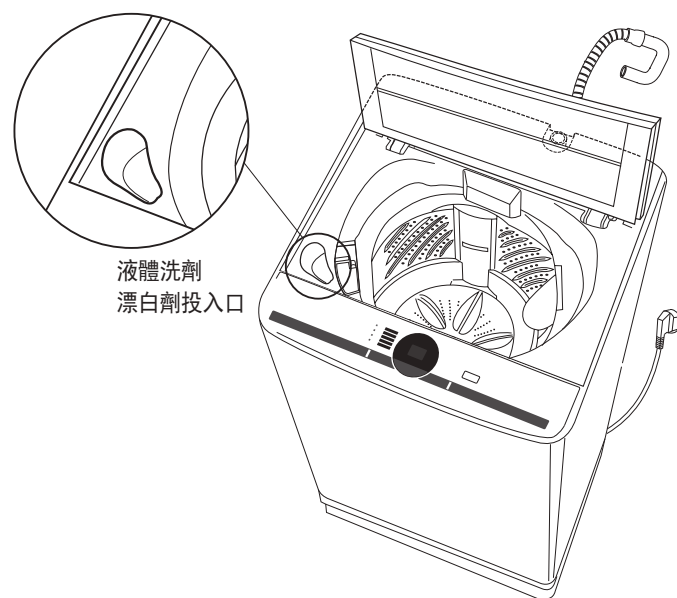

(NA-F60A7P)

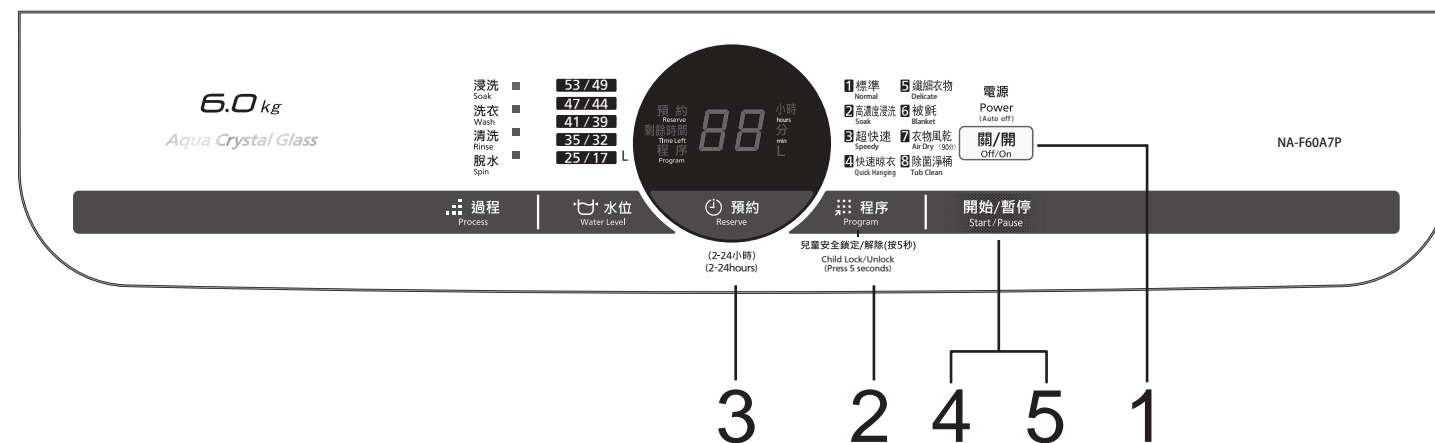

- |          |   |   |   |
|----------|---|---|---|
| <b>1</b> | Put the laundry in, and press the power OFF/ON button.                              | 放入衣物，按下電源“關/開”鈕。  | <ul style="list-style-type: none"> <li>• Open the water faucet.</li> <li>• 打開水龍頭。</li> </ul>  |
| <b>2</b> | Select the course you desire.   | 選擇洗滌程序。   | <ul style="list-style-type: none"> <li>• These courses can be reserved: Normal, Soak, Speedy, Quick Hanging, Blanket.</li> <li>• 可預約程序：標準、高濃度浸洗、超快速、快速晾衣、被氈。</li> </ul>   |
| <b>3</b> | Press the RESERVE button and set the time.  | 按預約鈕，設定時間。  | <ul style="list-style-type: none"> <li>• You can set the wash to finish up to 24 hours from the current time, in units of 1 hour.</li> <li>• To cancel the timer function, turn the power off by pressing the power OFF/ON button.</li> <li>• 可以以1小時為單位預約到24小時後。</li> <li>• 若要取消預約，按電源“關/開”鈕切斷電源。</li> </ul>                            |
|          |   | <b>Note</b>   | <b>注意</b>   |
|          |   | Depending on the water supply and drainage conditions, the wash may be finished later than the preset time. | 根據供水和排水條件不同，洗滌完成時間可能超過預約時間。   |
| <b>4</b> | Press the START/PAUSE button, measuring the amount of laundry.                      | 按下“開始/暫停”鈕，檢測衣物量。   | <ul style="list-style-type: none"> <li>• The machine will measure the laundry load by churning the laundry without any water, and indicate the appropriate water level.</li> <li>• The speedy and blanket course do not measure the amount of laundry.</li> <li>• 在無水狀態下攪動洗滌物，以檢測衣服重量並顯示所需水位。</li> <li>• 超快速程序和被氈程序不進行衣物量檢測。</li> </ul> |
|          |   | <b>Note</b>   | <b>注意</b>   |
|          |   | ■ To check the set item, press the RESERVE button.  | ■ 確認預約內容時按“預約”按鈕。   |
| <b>5</b> | Put in appropriate amount of detergent according to the water level. Close the lid. | 加入與水位相應的洗滌劑，關上洗衣機蓋。   |   |

When the buzzer sounds, washing is finished.

蜂鳴音響起時，洗滌完成。







# Custom Washing 自設洗滌

## Spin Only (Drain-Spin), etc. 僅脫水（排水-脫水）等

By pressing the PROCESS button, you can select your cycle combination such as "spin only" (drain), etc.

按“過程”按鈕，可選擇進行指定洗衣程序如脫水等運行。

<ul style="list-style-type: none"> <li>To reuse the wash water. 洗衣水的再利用。</li> </ul>		<ul style="list-style-type: none"> <li>After finishing the wash cycle, the machine stops with the wash water left in the tub. 洗滌完畢後，留下洗衣水停止。</li> </ul>
<ul style="list-style-type: none"> <li>To spin the laundry separately. 獨立脫水。</li> </ul>		<ul style="list-style-type: none"> <li>If there is water in the tub, the machine begins from draining it. 洗衣槽內有水時，從排水開始運行。</li> </ul>
<ul style="list-style-type: none"> <li>To reuse the rinse water. 清洗水的再利用。</li> </ul>		<ul style="list-style-type: none"> <li>After finishing the wash and rinse cycles, the machine stops with the rinse water left in the tub. 洗滌、清洗完畢後，留下清洗用水。</li> </ul>
<ul style="list-style-type: none"> <li>To wash the laundry without using detergent. 不加洗劑，只進行水洗時。</li> </ul>		<ul style="list-style-type: none"> <li>The machine automatically performs the wash and spin cycles without rinsing. 不進行清洗，而自動進行洗滌以及脫水。</li> </ul>
<ul style="list-style-type: none"> <li>To rinse and spin the laundry soaked with detergent. 對用洗滌劑浸泡過的衣物進行清洗和脫水。</li> </ul>		<ul style="list-style-type: none"> <li>If there is water in the tub, the machine begins from draining it and then perform the rinse cycle. 槽內有水時從排水開始，然後進行清洗。</li> </ul>

# Cancel End-of-Cycle Buzzer 取消洗滌結束時的蜂鳴音

- Press the OFF/ON button while pressing the START/PAUSE button, and keep pressing the START/PAUSE button for at least three seconds.
- The end-of-cycle buzzer is cancelled after 1 beep sound.
- To return to the original buzzer condition, carry out the operations in 1 and 2 again. The buzzer beeps twice.

電源  
Power  
(Auto off)



2 Press 按鈕

1 While pressing 按鈕時

- 在按下“開始/暫停”鈕的同時按下電源“關/開”鈕，持續按下“開始/暫停”鈕3秒鐘以上。
- 蜂鳴器“嗶嗶”響一次，洗滌結束時的蜂鳴音被取消。
- 如想恢復蜂鳴音，再次進行第1步和第2步的操作。此時蜂鳴音響2次。

# Change of Course 程序的轉換

Course 程序	Water level 水位	Soak 浸洗	Wash 洗衣	Rinse 清洗	Contents of Rinse 清洗內容	Spin 脫水	Required time 需要時間
NORMAL 標準	53 L	/	15 min 15分	2 times : 2次	Shower+Full tub 噴淋 儲水	2 min 30 s 2分30秒	Approx.46 min 約需46分鐘
	17 to 49 L 17 ~ 49 L			2 times : 2次	Full Tub Full Tub 儲水 儲水		
SOAK 高濃度浸洗	25 to 53 L 25 ~ 53 L	30 min 30分	15 min 15分	2 times : 2次	Full Tub Full Tub 儲水 儲水	2 min 30 s 2分30秒	Approx.73 to 81 min 約需73-81分鐘
SPEEDY 超快速	17 to 39 L 17 ~ 39 L	/	2 min 30 s 2分30秒	1 times : 1次	Refill Water 注水	2 min 30 s 2分30秒	Approx.18 to 22 min 約需18-22分鐘
QUICK HANGING 快速晾衣	53 L	/	15 min 15分	2 times : 2次	Shower+Full tub 噴淋 儲水	20 min 20分	Approx.63 min 約需63分鐘
	17 to 49 L 17 ~ 49 L			2 times : 2次	Full Tub Full Tub 儲水 儲水		
DELICATE 纖細衣物	39 to 49 L 39 ~ 49 L	/	3 min 3分	2 times : 2次	Full Tub Full Tub 儲水 儲水	40 s 40秒	Approx.33 to 36 min 約需33-36分鐘
BLANKET 被氈	53 L	/	15 min 15分	3 times : 3次	Full Tub Full Tub Full Tub 儲水 儲水 儲水	3 min 3分	Approx.73 min 約需73分鐘
AIR DRY 衣物風乾	/	/	/	/	/	90 min 90分	Approx.90 min 約需90分鐘
TUB CLEAN 除菌淨桶	/	61 min 61分	3 min : 3分	2 times : 2次	Full Tub Full Tub 儲水 儲水	10 min 10分	Approx.1.9 h 約需1.9小時

- According to water pressure, draining condition and laundry volume, the indicated washing, spinning time for the selected course may be different from the actual operation time.
- If you wish to change operations after start, until washing cycle, press the "START/PAUSE" button, then you can change the settings. After a change of course or change of washing mode, please turn the power OFF/ON again to resume operations.
- The shower rinse is that the shower spray will wash away any detergent left in the wet laundry while the spin tub rotates.
- The full tub rinse is the rinse which is carried on when the water level achieves certain extent.
- Refill water rinse is the rinse which is carried on when the water level achieves certain extent, and refilling water at the same time.

- 根據自來水水壓、排水條件和衣物等不同，程序運算的洗衣、脫水時間與實際運轉時間有可能不同。
- 開始之後想進行運轉變更時，到正在洗衣為止，按下“開始/暫停”按鈕則可進行切換。程序的變換以及變換洗衣以後的運轉時，請重新打開電源。
- 噴淋清洗是指一邊轉動洗衣槽一邊水像瀑布一樣地淋在衣服上，把洗滌劑沖走。
- 儲水清洗是指儲水到一定水位進行清洗。
- 注水清洗是指儲水到一定水位，一邊進水一邊清洗。

# Child Lock Mode 兒童安全鎖

## What is the Child Lock Mode?

If an infant opens the lid during the operation (when the tub contains water), a continuous buzzer sounds to call attention. The buzzer urges that the lid should be closed promptly. If the lid is left open for 5 seconds or more, the machine stops operation and starts draining, in order to prevent the child from falling and drowning in the tub.

- The Child Lock Mode does not lock the lid or buttons.

## 何謂兒童安全鎖?

如果幼兒在運轉中(洗衣槽內有水的狀態)打開洗衣機蓋,蜂鳴器就連續發響。那是促使馬上關閉洗衣機蓋。打開洗衣機蓋而放置5秒以上,考慮會有幼兒跌下槽內,洗衣機會強制排水。

- 兒童安全鎖並不會將洗衣機蓋或按鈕鎖住。

## When the water is drained

Emergency alarm is activated (display CL.U99 and a buzzer sounds).

Confirm that no child has fallen in the tub.

## 強制排水的時候

會啟動異常報知(顯示CL、U99蜂鳴器一直鳴叫)。請確認槽內並無孩童意外跌落。

## How to recover after the emergency alarm

Button operation is not accepted.

Unplug the power cord, and plug it in again after 5 seconds.

The original course has been cancelled. Start again from the beginning.

## 提示警號的關閉方法

不能用按鈕操作。

把電源插頭拔出插座,5秒後重新連接。

運轉中的程序被取消,所以請從頭再做過。

## In the following case, the Child Lock Mode cannot be activated. Do not leave the machine unattended with water in the tub.

- When the power is off
- When the drain hose is not laid down (Only for NA-F60A7)

## 下述場合兒童安全鎖不起作用,請不要開置儲了水的洗衣機。

- 電源[關]的時候
- 排水膠管未放下的時候 (只適用於NA-F60A7)

## How to set up

## 設定方法

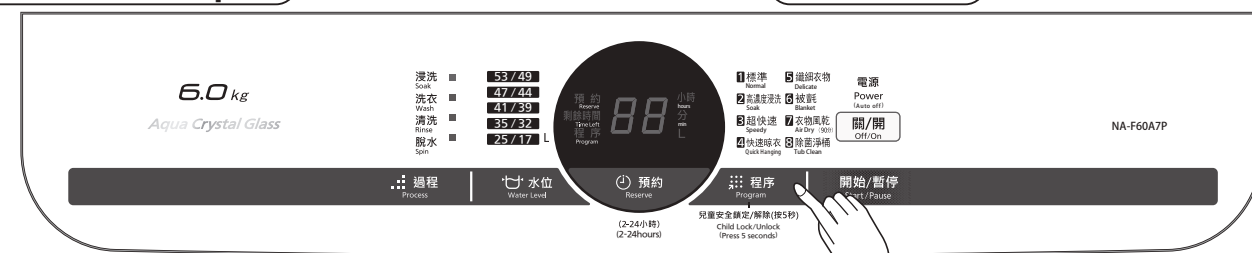

Press the power OFF/ON button.

Setting can be carried out by holding the PROGRAM button for 5 seconds or more.

The Child Lock Mode is set after 1 beep sound.

按下電源“關/開”鈕。

持續按下“程序”按鈕5秒以上,可以進行設定。蜂鳴器[嗶嗶]響一次,兒童安全鎖設定完。

## How to cancel the mode

Repeat the above procedure.

The Child Lock Mode is cancelled after 2 beep sounds.

## 解除方法

重複以上動作。

蜂鳴器響兩次,兒童安全鎖解除。



If "CL" is displayed when the power is turned on, it means that the child lock has been set.

在電源“開”的狀態下出現 CL 顯示時,表明設定了兒童安全鎖。

Once the setting has been made, light of courses will be on for 2 seconds each time the power is turned on.

一旦作出設定,每當接通電源時,所有程序的指示燈都將點亮2秒鐘。

# Clever Laundering 靈巧的洗滌加工

## How to use softener 柔順劑的使用方法

### How to use

- Before starting washing, put the softener in according to the laundry volume.

### 使用方法

- 洗滌前,根據衣物量(水位)加入柔順劑。

- Maximum volume is about 40 ml.
- 最大注入容量約40 ml。

- If it is difficult to put in, remove the softener inlet by pulling it toward you.

- 不容易注入時,請往前拉拔柔順劑盒。

\*Dilute the concentrated softener with twice amount of water.

\* 使用濃縮型柔順劑時,請用兩倍的水稀釋。

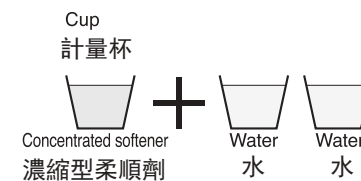

\*If you do not dilute concentrated softener, rust may form on the washing tub (stainless).

\* 如果直接使用濃縮型柔順劑,有可能使洗衣槽(不銹鋼)生鏽。

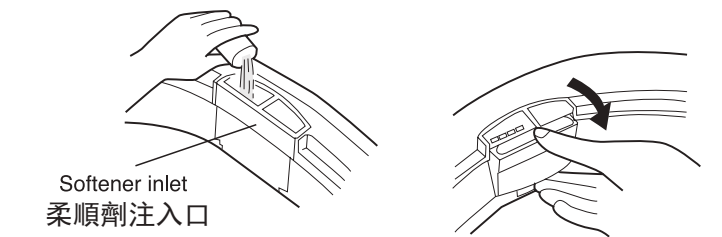

### Note

- \* Do not open the lid during spinning. Otherwise the softener will pour into the tub earlier, and the effect to the softener will be weakened.
- \* The softener will go out of sight during rinsing. This is because the softener moves to another place due to centrifugal force caused by spinning operations. However, the machine will automatically pour the softener during the last rinse.
- \* Softener hardens easily, so do not leave it in the softener inlet for hours (12 hours or longer).

### 注意

- \* 脫水時請不要打開洗衣機蓋。過早投入柔順劑會減弱效果。
- \* 清洗途中看不到,是因為脫水的離心力,使柔順劑移到別的地方,在最後清洗時自動投入。
- \* 柔順劑容易凝固,不要長時間(12小時以上)留在柔順劑投入盒內。

## How to use bleach 漂白劑的使用方法

### Liquid bleach

- Before putting in the items, dilute the liquid bleach with the same amount of water and pour it into the liquid detergent and bleach inlet.

Liquid detergent and bleach inlet 液體洗滌劑 漂白劑投入口

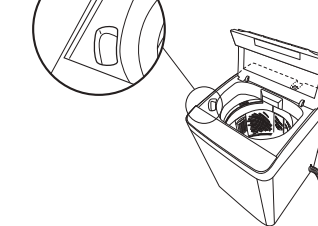

### 液體漂白劑

- 在放入衣物之前,用等量的水稀釋液體漂白劑,放入液體洗滌劑和漂白劑投入口內。

### Powder bleach

- Put the powder bleach directly into the tub during water filling.
- \* Follow the instructions on the bleach container.

### 漂白粉

- 在供水過程中直接將漂白粉加入洗衣槽內。
- \* 請按照漂白粉包裝瓶上的說明使用。

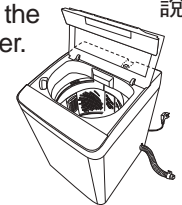

### Note

- Powder soap is not easily dissolved compared to synthetic detergents. Make sure to rinse the laundry thoroughly. If it does not rinse well, the laundry may be tinged with yellow or smell of soap.
- If too much soap is added, or it is added directly to cold water, residue and clumps which are not completely dissolved will stick to the inside of the tub and hose. These may float up and spoil the laundry. In this case, use the washing tub cleaner (sold separately) exclusively for washing machines. Consult your dealer. ( See page 17 )

### 注意

- 肥皂粉不如合成洗滌劑容易溶解,清洗一定要徹底。否則,衣物可能會染上黃色或帶有肥皂粉的味道。
- 如果肥皂粉加入過多,或者直接加入冷水中,未充分溶解的殘渣和硬塊會黏在洗衣槽和膠管內。它們會浮起並弄髒衣物。這種情況下,請使用洗衣槽清潔劑(另售)見第17頁。請向銷售店查詢。



# Laundry Tips

## 洗滌方法的幾項建議

● Put bulky items and items that may float easily into the tub first.

● 首先放入體積大和容易浮於水面的衣物。

Examples of items that may float easily

- Items inside thin-mesh nets
- Fleece materials which are 100% synthetic or blend
- Items such as jumpers with 100% synthetic facing or backing
- 放入網袋中的物品
- 絨頭織物等100%合成纖維或混合材質衣物
- 工作服等的面料和襪料為100%纖維的衣物

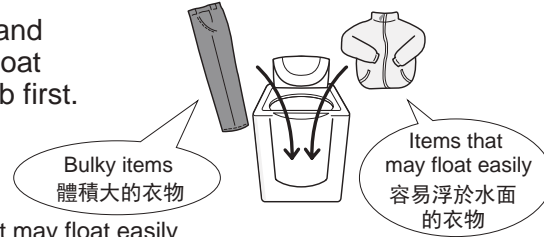

● When washing items such as those mentioned at the left, let the tub partly fill, then stop the water and press down on the items lightly, and then let the water finish filling.

● 對於左述的衣物，在加水後請用手輕輕地從上面按壓，使其充分吸收水分。



● Towels and other items made from towelling material that might produce lint should be washed separately.

● If you are concerned that items may produce lint, increase the number of rinses.

● increase the water volume for washing.

- 容易產生碎線頭的毛巾、浴巾應分開洗滌。
- 擔心附著碎線頭時，可增加清洗次數。
- 將水量設定得略多一些進行洗滌。

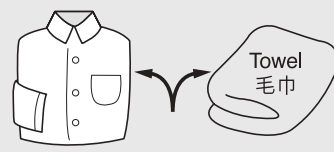

Please wash separately  
分開洗滌效果更佳

If lint collects on items being washed

衣物上附著了碎線頭時



Use sellotape to remove the lint.  
用透明膠紙去除碎線頭。

### Stains processing before washing 局部污漬部位的洗前處理

● Collar/Sleeves 衣領/衣袖

Paint with the dedicated decontamination detergent at the collar, sleeves stains.

在衣領、衣袖污漬部位塗上專用去污洗滌劑。



● Stains 污漬

Paint the decontamination detergent or oxygen-containing series bleach at the spot.

在污漬處塗上去污洗滌劑或含氧系列漂白劑。



● Sludge/Solid stains 污泥/固體污漬  
Curry, chili, etc (咖喱、辣椒等)

Paint the dedicated detergent soap or at the spot, then Scrub.

在污漬處塗上專用洗滌劑或肥皂後用手搓洗。



### The clothing need to be put in a washing net(washing with other clothing)

要裝入網狀洗衣袋的衣服(與其它衣物一同洗滌)

- Put in bra with metal trunnion ring, stockings a store-bought washing net. 帶有金屬托圈的胸圍、絲襪請放在網狀洗衣袋中進行洗滌。(防止金屬托圈變形和刮傷絲襪)
- clothing with lace lingerie. 附有蕾絲花邊的衣物和內衣。



### Checking of the clothes 衣服的检查

● Be sure to remove things such as keys, pins and coins from the laundry.

請檢查衣物的口袋，將袋內尖利物品取出，如髮夾、硬幣等。否則會損傷衣物。



● Tie the strings/straps of aprons, pillowcases and the like, close any fasteners and reverse the garments. 請將圍裙、枕套等物的袋子繫緊，衣物上有拉鍊或堅硬飾物的請拉上拉鍊等，將其由內向外翻。否則會損傷衣物。



● The clothing which is easy to fade must be washed separately. (Prevent mutual infection) 容易褪色的衣物請分開洗滌。(防止互染)

- Red or dark blue clothing
- Cowboy clothing
- 紅色或深藍色等衣物
- 牛仔衣物等

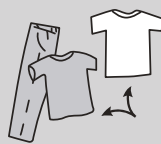

● Remove any hair, sand or dirt with a brush.

頭髮、寵物毛、砂粒或大顆粒的垃圾等，請事先用刷子刷淨。



● Turn inside out any garments which give off lint or lint balls. 將容易出毛絨或毛球的衣物由內向外翻出。



● Prevent static electricity.

防止產生靜電。Considering the clothing which may generate static electricity. Please use softener when washing. 根據衣物不同，可能會產生靜電。洗滌時請使用柔順劑。



# Maintenance

## 保養

### Lint filter 絲屑過濾袋

■ Clean the lint filter after each operation.

■ 每次使用後請清洗絲屑過濾袋。

Remove the filter.  
拆下過濾袋。

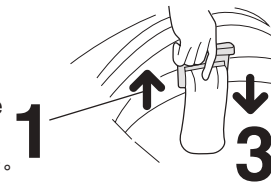

Put the filter back in. Make sure it clicks into place. 安裝過濾袋。安裝時請確認聽到了喀嗒聲。

2 Remove the lint from the filter.  
清除過濾袋內的毛絨。

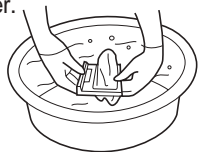

■ When the filter is torn, etc.

Obtain another one from the place of service center.

■ 當過濾袋發生破損等情況時

在服務店再購買一隻。

### Water supply valve filter 供水閥過濾網

■ When water supply seems constricted.

\* Be absolutely sure to follow the procedure as described, otherwise water will spray out.

■ 供水情況不好時

\* 務請遵守以下操作順序，否則會發生噴水現象。

1 Turn off the water faucet. 關閉水龍頭。

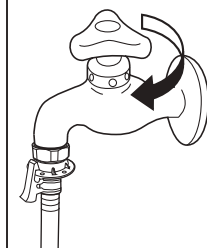

2 Press the power OFF/ON button. 按下電源“關/開”鈕。

3 Press the WATER LEVEL button. 按下“水位”鈕。

The water level lamp will light up. 水位指示燈將亮起。

4 Press the START/PAUSE button. 按下“開始/暫停”鈕。幾秒鐘後，按下“關/開”鈕關閉電源。

5 Loosen the nut. 將螺母擰鬆。

6 Take off the hose. 卸下水管。

7 Clean the filter. 清洗過濾網。

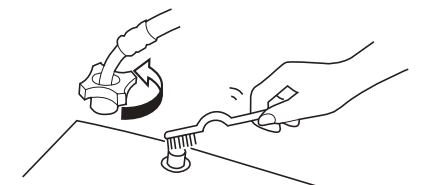



## Main unit and Tub

## 機體和洗衣槽

### ■ Main unit

- Wipe with a soft cloth. Use a neutral dish washing liquid or soap for stubborn places.
- \* Do not apply water directly.
- \* Do not use cleanser, paint benzene, alcohol, kerosene, etc.
- \* Follow any instructions that come with a chemically treated cloth.

### ■ 機體

- 用柔軟的布擦拭。如果髒污嚴重，使用廚房用中性洗滌劑或洗滌皂擦拭。
- \* 請勿直接用水沖洗。
- \* 請勿使用去污粉、香蕉水、酒精、煤油等清潔劑。
- \* 使用化學性抹布時，請參照說明書。

### ■ Upper part of the tub

- Wipe with a damp cloth.
- \* Do not apply water directly. Otherwise, the floor could get wet.

### ■ 洗衣槽的上部

- 用濕抹布擦拭。
- \* 請勿直接用水沖洗，否則會弄濕地板。

### ■ Cleaning the tub (stainless steel type)

- To remove rust (from metal objects in the laundry) which has settled in the tub, use dish washing liquid (for stain-less steel).
- To remove water scale, use a bathtub cleaner.
- \* When the color of the jeans is transferred to the resin portions of the tub or pulsator, dissolve synthetic powder detergent with water, apply a small amount to a cloth and wipe the colored portions.

### ■ 清潔洗衣槽（不銹鋼製）

- 使用廚房用中性洗滌劑（不銹鋼用）清除鐵銹（來自衣物的金屬物件）。使用浴缸洗滌劑清除水垢。
- \* 如果洗衣槽的樹脂材料部分和旋轉葉輪染上了牛仔服的顏色，用水溶解合成洗衣粉，用抹布蘸少量溶液擦拭染色部位。

### ■ To prevent black mold

- Press PROGRAM button to select "TUB HYGIENE" and operate once a month. See page 19 for details.
- \* Black mold appearing outside the tub may stain the items brown or black after washing.
- \* In this case, you are advised to clean the washing / spinning tub with washing tub cleaner (sold separately; exclusively for washing machines.)

### ■ 為防止長黴

- 請約一月一次以程序鈕選擇“除菌淨桶”運轉。詳細情況請參照第19頁。
- \* 洗衣槽的外側長黴後，會使洗滌後的衣物上沾有茶色或黑色的污垢。
- \* 建議以另售的洗衣機專用清潔劑來洗淨洗衣槽。

## The filter behind of washing machine

## 洗衣機後側過濾器 (NA-F60A7P)

- Please clean the filter regularly, the filter label behind of washing machine have the operating instruction for the cleaning. (Recommended cleaning cycle is one year.)

- 請定期清洗過濾器，請參照洗衣機後側的過濾器注意標貼。（建議清洗週期為一年。）

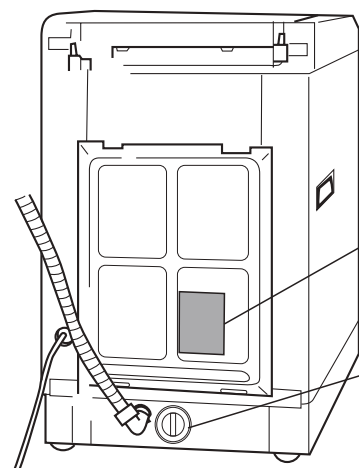

Filter label  
過濾器注意標貼

Filter  
過濾器

過濾器注意標貼 Filter label	
拆卸 Disassembly	安裝 Installation
<p>① 擋筋 Block tendon</p> <p>排水管 Drain hose 線屑過濾器 Filter</p> <p>② 左旋 Left revolve</p> <p>容量500 ml的容器 500 ml capacity container</p> <p>打開過濾器前，在下方放置容量500 ml的容器收集殘水。 Before open the filter, place the capacity of 500 ml container below it to collect residual water.</p>	<p>① 過濾器開口向右 Filter aperture rightward</p> <p>保持過濾器開口向右的狀態放入洗衣機內。 Keep the filter aperture rightward, and put it into the washing machine.</p> <p>② 右旋 Right revolve</p> <p>右旋至被擋筋擋住為止，大約需要旋轉三圈。 Right revolve about three circles until it is blocked by block tendon.</p>
<p>建議由授權維修部或具有專門技術的人員進行清理過濾器工作！ Advise to clean up the filter by authorized service agent or qualified persons.</p>	

# Troubleshooting

## 故障維修

### Check the following before request service 報修前檢查以下項目

Symptoms 現象	Causes 原因
<p>WASH 洗衣</p> <p>Tub begins filling in the middle of the wash. 洗滌的中途供水。</p>	<ul style="list-style-type: none"> <li>When the water level goes down, the tub fills automatically.</li> <li>水位下降時，洗衣機自動供水。</li> </ul>
<p>Water is not supplied. 不能供水。</p>	<ul style="list-style-type: none"> <li>Check if the water faucet is turned on.</li> <li>Check if the water supply and the water supply hose are frozen.</li> <li>Is the water supply cut off?</li> <li>Check if the connection of the water supply hose is clogged with dirt. Please refer to "water supply valve filter" on page 27.</li> <li>檢查是否打開了水龍頭。</li> <li>檢查水管和供水膠管是否結冰。</li> <li>是否停水？</li> <li>檢查供水膠管的接頭處是否被殘渣堵塞。請參照第27頁“供水閥過濾網”。</li> </ul>
<p>The water level is too high for the amount of laundry being washed. 對於被洗滌的衣物水位過高。</p>	<ul style="list-style-type: none"> <li>When the laundry is already soaked with water before the wash or if there is water in the tub before the wash is the water level will sometimes be higher.</li> <li>衣物在洗滌前浸過水，或洗衣槽內有積水時，水位有時會過高。</li> </ul>
<p>The water level is too low for the amount of laundry being washed. 對於被洗滌的衣物水位過低。</p>	<ul style="list-style-type: none"> <li>With light clothes made of synthetic or blended fabric, the water level will sometimes be lower.</li> <li>洗滌合成纖維或混合材質的輕質衣物時，水位有時會過低。</li> </ul>
<p>Water does not flow through the lint filter. "Double Cross Cascade" does not operate. 絲屑過濾網不透水。不進行高低式瀑布水流洗滌。</p>	<ul style="list-style-type: none"> <li>With the "DELICATE" courses and the lower water level, water sometimes will not flow through the lint filter. "Double Cross Cascade" does not operate when these settings have been selected.</li> <li>在使用“纖細衣物”程序和選擇較低水位時，有時不會從絲屑過濾網中出水，也不會進行高低式瀑布水流洗滌。</li> </ul>

Symptoms 現象	Causes 原因
Midway during spinning, the operation suddenly changes to rinsing. 在脫水中途，行程突然改變至清洗。	<ul style="list-style-type: none"> <li>If the laundries in the tub bundle to one side, the washing machine automatically will unravel them by rinsing. (Put laundries into the tub as flat as possible.)</li> <li>若衣物偏向一邊，會進行清洗以自動修正衣物偏向一邊的現象。(請儘量把衣物弄平)</li> </ul>
During spinning, the laundry and the spinner rotate with irregular movements. 脫水時，洗衣槽不規則旋轉。	<ul style="list-style-type: none"> <li>To avoid foam building up, the washing tub turns slowly and quickly.</li> <li>洗衣槽旋轉忽快忽慢，以減少肥皂泡的殘留。</li> </ul>
If you start with the Rinse cycle, the tub does not fill with water. 從清洗步驟開始洗滌時，洗衣槽不供水。	<ul style="list-style-type: none"> <li>When there is no water in the tub, the machine starts from the "Spin" cycle to remove any water or wash water in the clothing. After the "Spin" cycle finishes, the machine starts to supply water. (When there is water in the tub, the operation starts with draining.)</li> <li>洗衣槽內沒有水時，洗衣機從脫水步驟開始，脫去衣物中含有的水分。脫水步驟完成後，洗衣機開始供水。(洗衣槽內有水時，則從排水步驟開始。)</li> </ul>
The buttons do not work. 按鈕操作不靈。	<ul style="list-style-type: none"> <li>After the washing machine starts operation, only WATER LEVEL, PROCESS buttons are available during washing process. To change the other settings, press POWER OFF/ON button and start from the beginning.</li> <li>開始運行後，只有“水位”鈕和“過程”鈕可以操作。其它操作，必須按“關/開”鈕，重新進行設定。</li> </ul>
Buzzer does not stop and water is drained. 蜂鳴器鳴響不止，開始進行排水。	<ul style="list-style-type: none"> <li>Has the mode been set to the "Child Lock Mode"? When the tub contains water in the Child Lock Mode, the machine starts draining while activating the emergency alarm if the lid is left open for 5 seconds or more. In this case, check if children had opened the lid or were fallen into the tub.</li> <li>設定兒童安全鎖後，在洗衣槽內有水的情況下，如果打開蓋子5秒以上，則蜂鳴器鳴響，並開始排水。此時，要檢查是否小孩打開了蓋子或是掉進了洗衣槽裏。</li> </ul>
Does not run at all. 完全不運轉。	<ul style="list-style-type: none"> <li>Check if there is power failure.</li> <li>Check if the power fuse has been down or the breaker is actuating.</li> <li>Check if the power plug is plugged in thoroughly.</li> <li>Check if the POWER button has been pressed.</li> <li>Has the water faucet been turned on?</li> <li>Check if the START button has been pressed.</li> <li>Has the machine been programmed?</li> <li>Is the Lid securely closed?</li> <li>檢查是否有電源故障。</li> <li>檢查電源保險是否斷開或斷路器是否啟動。</li> <li>檢查電源插頭是否插緊。</li> <li>檢查是否按了電源鈕。</li> <li>水龍頭已打開了嗎？</li> <li>檢查是否按了開始鈕。</li> <li>是否已設定了洗衣程序？</li> <li>蓋子是否已確實關閉？</li> </ul>
Appear "CL". 顯示 "CL"。	<ul style="list-style-type: none"> <li>Child Lock Mode has been set, not abnormality, see Page 24.</li> <li>設定了兒童安全，並非異常，見第24頁。</li> </ul>

## If indications appear as such on the display panel ( Buzzer sounds, U and digital display alternately )

顯示屏如果出現下列顯示時 (蜂鳴器鳴響，U與數字交替顯示)

Lighting status of the indication lamp

顯示燈的顯示內容

<p>U 11</p> <p>Water cannot drained out. 不能排水</p>	<ul style="list-style-type: none"> <li>Check if abnormalities listed below are seen in the drain hose. <ul style="list-style-type: none"> <li>Is it clogged with lint?</li> <li>Is it crushed?</li> <li>Is the tip soaked in water?</li> <li>Is any part of the hose higher than 1 m? (NA-F60A7P)</li> <li>Is any part of the hose higher than 10 cm? (NA-F60A7)</li> <li>Is the hose being used too small?</li> <li>Is the water in the hose frozen?</li> <li>Is the rear filter blocked? (NA-F60A7P)</li> </ul> </li> <li>檢查排水膠管是否有下列異常現象。 <ul style="list-style-type: none"> <li>是否被毛絨堵塞？</li> <li>是否有破裂？</li> <li>管頭是否浸在水中？</li> <li>膠管是否有超過1 m高度的部分？(NA-F60A7P)</li> <li>膠管是否有超過10 cm高度的部份？(NA-F60A7)</li> <li>使用的膠管是否太細？</li> <li>膠管內的水是否結冰？</li> <li>後側過濾器是否被線屑堵塞？(NA-F60A7P)</li> </ul> </li> </ul> <p>Restart by opening and closing the lid.</p> <p>將洗衣機蓋開、關之後，會重新開始運轉。</p>
<p>U 12</p> <p>Lid is open. 蓋開著</p>	<ul style="list-style-type: none"> <li>Is the lid open? Close the lid.</li> <li>洗衣機蓋是否打開？關上洗衣機蓋。</li> </ul>
<p>U 13</p> <p>Clothes cannot spin-dry. 不能脫水</p>	<ul style="list-style-type: none"> <li>Is the washing machine in an unsteady position, or is it on an inclined floor surface? <ul style="list-style-type: none"> <li>Restart by opening and closing the lid.</li> </ul> </li> <li>Is the laundry unevenly distributed in the tub? <ul style="list-style-type: none"> <li>Arrange the laundry evenly in the tub, then close the lid.</li> </ul> </li> <li>洗衣機是否不平穩，或者放在傾斜的地面上？ <ul style="list-style-type: none"> <li>將洗衣機蓋開、關之後，會重新開始運轉。</li> </ul> </li> <li>洗衣機內的衣物是否都集中到了一邊？ <ul style="list-style-type: none"> <li>請將衣物重新放置均勻，關上洗衣機蓋。</li> </ul> </li> </ul>
<p>U 14</p> <p>Cannot fill with water. 不能注水</p>	<ul style="list-style-type: none"> <li>Check if the water faucet is turned on.</li> <li>Is the water supply frozen?</li> <li>Is the water supply cut off?</li> <li>Is the connection of the water supply hose clogged with dirt? See page 27 for detail.</li> <li>檢查是否打開了水龍頭。</li> <li>檢查水管和供水膠管是否結冰。</li> <li>是否停水？</li> <li>供水膠管的接頭處是否被殘渣堵塞？</li> <li>請參照第27頁。</li> </ul> <p>Restart by opening and closing the lid.</p> <p>將洗衣機蓋開、關之後，會重新開始運轉。</p>
<p>U 99</p> <p>Buzzer keeps sounding. 蜂鳴器持續鳴響</p>	<ul style="list-style-type: none"> <li>Is the lid is left open for 5 seconds or more, while the tub contains water?</li> <li>The Child Lock Mode is activated and the water is drained. Unplug the power cord, and plug it again after 5 seconds. See page 24 for details.</li> <li>是否在有水的時候打開蓋5秒以上呢？</li> <li>兒童安全鎖起作用，強制排水。請把電源插頭拔出插座，5秒後重新連接。請參照第24頁。</li> </ul>