

Installation Instruction

Air conditioner

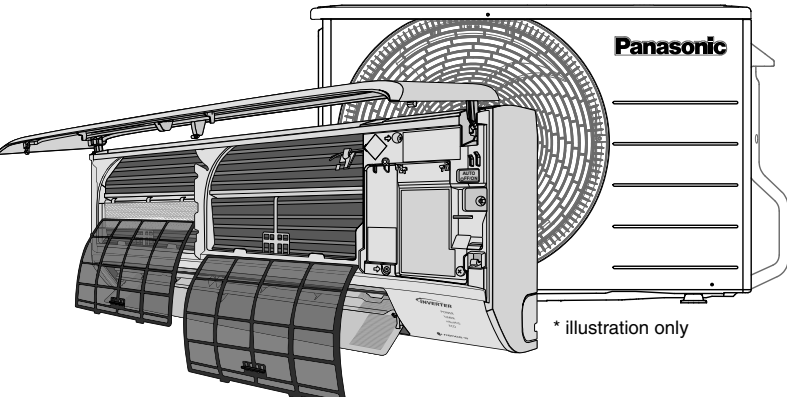

MODEL NO : CS/CU-YU9*** (1.0HP)
CS/CU-YU12*** (1.5HP)

CAUTION

R32 REFRIGERANT

This Air Conditioner contains and operates with refrigerant R32.

THIS PRODUCT MUST ONLY BE INSTALLED OR SERVICED BY QUALIFIED PERSONNEL.

Refer to National, State, Territory and local legislation, regulations, codes, installation & operation manuals, before the installation, maintenance and/or service of this product.

Explanation of symbols displayed on the indoor unit or outdoor unit.

	WARNING	This symbol shows that this equipment uses a mildly flammable refrigerant. If the refrigerant is leaked, together with an external ignition source, there is a possibility of ignition.
	CAUTION	This symbol shows that the Installation Manual should be read carefully.
	CAUTION	This symbol shows that a service personnel should be handling this equipment with reference to the Installation Manual.
	CAUTION	This symbol shows that there is information included in the Operation Manual and/or Installation Manual.

SAFETY PRECAUTIONS

- Read the following "SAFETY PRECAUTIONS" carefully before installation.
 - Electrical work must be installed by a licensed electrician. Be sure to use the correct rating of the power plug and main circuit for the model to be installed.
 - The caution items stated here must be followed because these important contents are related to safety. The meaning of each indication used is as below. Incorrect installation due to ignoring of the instruction will cause harm or damage, and the seriousness is classified by the following indications.
- | | | | | | |
|--|----------------|---|---|--|--|
| | WARNING | This indication shows the possibility of causing death or serious injury. | The items to be followed are classified by symbols: | | Symbol with white background denotes item that is PROHIBITED. |
| | CAUTION | This indication shows the possibility of causing injury or damage to properties only. | | | Symbol with dark background denotes item that must be carried out. |
- Carry out test running to confirm that no abnormality occurs after the installation. Then, explain to user the operation, care and maintenance as stated in instructions. Please remind the customer to keep the operating instructions for future reference.
- If the equipment is transferred to a new user or delivered to a recycling plant, be sure also to hand over the manual.

WARNING

- Do not use means to accelerate the defrosting process or to clean, other than those recommended by the manufacturer. Any unit method or using incompatible material may cause product damage, burst and serious injury.
 - Do not install outdoor unit near handrail of veranda. When installing air-conditioner unit on veranda of a high rise building, child may climb up to outdoor unit and cross over the handrail causing an accident.
 - Do not use unspecified cord, modified cord, joint cord or extension cord for power supply cord. Do not share the single outlet with other electrical appliances. Incorrect, poor insulation or over current will cause electrical shock or fire.
 - Do not tie up the power supply cord into a bundle by hand.
 - Abnormal temperature rise on power supply cord may happen.
 - Do not insert your fingers or other objects into the unit, high speed rotating fan may cause injury.
 - Do not sit or step on the unit, you may fall down accidentally.
 - Keep plastic bag (packaging material) away from children, it may cling to nose and mouth and prevent breathing.
 - When installing or relocating air conditioner, do not let any substance other than the specified refrigerant, eg. air etc mix into refrigeration cycle (piping). Mixing of air etc. will cause abnormal high pressure in refrigeration cycle and result in explosion, injury etc.
 - Do not pierce or burn as the appliance is pressurized. Do not expose the appliance to heat, flame, sparks, or other sources of ignition. Else, it may explode and cause injury or death.
 - Do not add or replace refrigerant other than specified type. It may cause product damage, burst and injury etc.
- For R32/R410A model, use piping, flare nut and tools which is specified for R32/R410A refrigerant. Using of existing (R22) piping, flare nut and tools may cause abnormally high pressure in the refrigeration cycle, and possibly result in explosion and injury.
 - For R32 and R410A, the same flare nut on the outdoor unit side and pipe can be used.
 - Since the working pressure for R32/R410A is higher than that of refrigerant R22 model, replacing conventional piping and flare nuts on the outdoor unit side are recommended.
 - If reuse piping is unavoidable, refer to instruction "IN CASE OF REUSING EXISTING REFRIGERANT PIPING"
 - Thickness of copper pipes used with R32/R410A must be more than 0.8 mm. Never use copper pipes thinner than 0.8 mm.
 - It is desirable that the amount of residual oil less than 40 mg/10 m.
 - Engage authorized dealer or specialist for installation.
 - If installation done by the user is incorrect, it will cause water leakage, electrical shock or fire.
 - For refrigeration system work, install according to this installation instructions strictly. If installation is defective, it will cause water leakage, electrical shock or fire.
 - Use the attached accessories parts and specified parts for installation. Otherwise, it will cause the set to fall, water leakage, fire or electrical shock.
 - Install at a strong and firm location which is able to withstand weight of the set. If the strength is not enough or installation is not properly done, the set will drop and cause injury.
 - For electrical work, follow the national regulation, legislation and this installation instructions. An independent circuit and single outlet must be used. If electrical circuit capacity is not enough or defect found in the electrical work, it will cause electrical shock or fire.
- Do not use joint cable for indoor / outdoor connection cable. Use the specified indoor/outdoor connection cable, refer to instruction 9 "CONNECT THE CABLE TO THE INDOOR UNIT and connect tightly for indoor/outdoor connection. Clamp the cable so that no external force will have impact on the terminal. If connection or fixing is not perfect, it will cause heat up or fire at the connection.
 - Wire routing must be properly arranged so that control board cover is fixed properly. If control board cover is not fixed perfectly, it will cause fire or electrical shock.
 - This equipment is strongly recommended to be installed with Earth Leakage Circuit Breaker (ELCB) or Residual Current Device (RCD). Detailed knowledge of and skills in handling flammable refrigerants, personal protective equipment, refrigerant leakage prevention, handling of cylinders, charging, leak detection, recovery and disposal; and,
 - Continuously undergo regular further training to maintain this expertise.
 - Air-conditioner piping in the occupied space shall be installed in such a way to protect against accidental damage in operation and service.
 - Precautions shall be taken to avoid excessive vibration or pulsation to refrigerating piping.
 - Ensure protection devices, refrigerating piping and fittings are well protected against adverse environmental effects (such as the danger of water collecting and freezing in relief pipes or the accumulation of dirt and debris).
 - Expansion and contraction of long runs piping in refrigerating systems shall be designed and installed securely (mounted and guarded) to minimize the likelihood hydraulic shock damaging the system.
 - Protect the refrigerating system from accidental rupture due to moving furniture or reconstruction activities.
 - To ensure no leaking, field-made refrigerant joints indoors shall be tightness tested. The test method shall have a sensitivity of 5 grams per year of refrigerant or better under a pressure of at least 0.25 times the maximum allowable pressure (>1.04MPa, max 4.15MPa). No leak shall be detected.

CAUTION

- This equipment must be properly earthed. Earth line must not be connected to gas pipe, water pipe, earth of lightning rod and telephone. Otherwise, it may cause electrical shock in case of equipment breakdown or insulation breakdown.
- ### CAUTION
- Do not install the unit in a place where leakage of flammable gas may occur. In case gas leaks and accumulates at surrounding of the unit, it may cause fire.
 - Prevent liquid or vapor from entering sumps or sewers since vapor is heavier than air and may form suffocating atmospheres.
 - Do not release refrigerant during piping work for installation, re-installation and during repairing refrigeration parts. Take care of the liquid refrigerant, it may cause frostbite.
 - Do not install this appliance in a laundry room or other location where water may drip from the ceiling, etc.
 - Do not touch the sharp aluminium fin, sharp parts may cause injury.
- Carry out drainage piping as mentioned in installation instructions.
 - If drainage is not perfect, water may enter the room and damage the furniture.
 - Select an installation location which is easy for maintenance. Incorrect installation, service or repair of this air conditioner may increase the risk of rupture and this may result in loss damage or injury and/or property.
 - Power supply connection to the room air conditioner.
 - Use power supply cord 3 x 1.5 mm² (1.0 - 1.5HP), type designation 60245 IEC 57 or heavier cord.
 - Connect the power supply cord to the mains using one of the following method.
 - Power supply point should be in easily accessible place for power disconnection in case of emergency.
 - In some countries, permanent connection of this air conditioner to the power supply is prohibited.
 - Power supply connection to the receptacle using power plug.
 - Use an approved 15/16 A (1.0 - 1.5HP) power plug with earth pin for the connection to the socket.
 - Power supply connection to a circuit breaker for the permanent connection.
 - Use an approved 16 A (1.0 - 1.5HP) circuit breaker for the permanent connection. It must be a double pole switch with a minimum 3.0 mm contact gap.
 - Installation work. It may need two people to carry out the installation work.
 - Keep any required ventilation openings clear of obstruction.

PRECAUTION FOR USING R32 REFRIGERANT

- Pay careful attention to the following points and the installation work procedures.
- ### WARNING
- The appliance shall be stored, installed and operated in a well ventilated room with indoor floor area larger than A_{min} (m²) [refer Table A] and without any continuously operating ignition source. Keep away from open flames, any operating gas appliances or any operating electric heater. Else, it may explode and cause injury or death.
 - The mixing of different refrigerants within a system is prohibited. Models that use refrigerant R32 and R410A have a different charging port thread diameter to prevent erroneous charging with refrigerant R22 and for safety.
 - Therefore, check beforehand. (The charging port thread diameter for R32 and R410A is 12.7 mm (1/2 inch).)
 - Ensure that foreign matter (oil, water, etc.) does not enter the piping.
 - Also, when storing the piping, securely seal the opening by pinching, taping, etc. (Handling of R32 is similar to R410A.)
 - Operation, maintenance, repairing and refrigerant recovery should be carried out by trained and certified personnel in the use of flammable refrigerants and as recommended by the manufacturer. Any personnel conducting an operation, servicing or maintenance on a system or associated parts of the equipment should be trained and certified.
 - Any part of refrigerating circuit (evaporators, air coolers, AHU, condensers or liquid receivers) or piping should not be located in the proximity of heat sources, open flames, operating gas appliance or an operating electric heater.
 - The user/owner or their authorized representative shall regularly check the alarms, mechanical ventilation and detectors, at least once a year, where as required by national regulations, to ensure their correct functioning.
 - A logbook shall be maintained. The results of these checks shall be recorded in the logbook.
 - In case of ventilations in occupied spaces shall be checked to confirm no obstruction.
 - Before a new refrigerating system is put into service, the person responsible for placing the system in operation should ensure that trained and certified operating personnel are instructed on the basis of the instruction manual about the construction, supervision, operation and maintenance of the refrigerating system, as well as the safety measures to be observed, and the properties and handling of the refrigerant used.
 - The general requirement of trained and certified personnel are indicated as below:
 - Knowledge of legislation, regulations and standards relating to flammable refrigerants; and,
 - Detailed knowledge of and skills in handling flammable refrigerants, personal protective equipment, refrigerant leakage prevention, handling of cylinders, charging, leak detection, recovery and disposal; and,
 - Able to understand and to apply in practice the requirements in the national legislation, regulations and Standards; and,
 - Continuously undergo regular further training to maintain this expertise.
 - Air-conditioner piping in the occupied space shall be installed in such a way to protect against accidental damage in operation and service.
 - Precautions shall be taken to avoid excessive vibration or pulsation to refrigerating piping.
 - Ensure protection devices, refrigerating piping and fittings are well protected against adverse environmental effects (such as the danger of water collecting and freezing in relief pipes or the accumulation of dirt and debris).
 - Expansion and contraction of long runs piping in refrigerating systems shall be designed and installed securely (mounted and guarded) to minimize the likelihood hydraulic shock damaging the system.
 - Protect the refrigerating system from accidental rupture due to moving furniture or reconstruction activities.
 - To ensure no leaking, field-made refrigerant joints indoors shall be tightness tested. The test method shall have a sensitivity of 5 grams per year of refrigerant or better under a pressure of at least 0.25 times the maximum allowable pressure (>1.04MPa, max 4.15MPa). No leak shall be detected.

- ### 2-10. Checks to electrical devices
- Repair and maintenance to electrical components shall include initial safety checks and component inspection procedures.
 - Initial safety checks shall include but not limit to:-
 - That capacitors are discharged: this shall be done in a safe manner to avoid possibility of sparking.
 - That there is no live electrical components and wires are exposed while charging, recovering or purging the system.
 - That there is continuity of earth bonding.
 - At all times the manufacturer's maintenance and service guidelines shall be followed.
 - If in doubt consult the manufacturer's technical department for assistance.
 - If a fault exists that could compromise safety, then no electrical supply shall be connected to the circuit until it is satisfactorily dealt with.
 - If the fault cannot be corrected immediately but it is necessary to continue operation, an adequate temporary solution shall be used.
 - The owner of the equipment must be informed or reported so all parties are advised thereinafter.

- ### 3. Repairs to sealed components
- During repairs to sealed components, all electrical supplies shall be disconnected from the equipment being worked upon prior to any removal of sealed covers, etc.
 - It is absolutely necessary to have an electrical supply to equipment during servicing, then a permanently operating form of leak detection shall be located at the most critical point to warn of a potentially hazardous situation.
 - Particular attention shall be paid to the following to ensure that by working on electrical components, the casing is not altered in such a way that the level of protection is affected. This shall include damage to cables, excessive number of connectors, terminals not made to original specification, damage to seals, incorrect fitting of glands, etc.
 - Ensure that apparatus is mounted securely.
 - Ensure that seals or sealing materials have not degraded such that they no longer serve the purpose of preventing the ingress of flammable atmospheres.
 - Replacement parts shall be in accordance with the manufacturer's specifications.
- NOTE: - The use of silicon sealant may inhibit the effectiveness of some types of leak detection equipment. Intrinsically safe components do not have to be isolated prior to working on them.

- ### 4. Repair to intrinsically safe components
- Do not apply any permanent inductive or capacitance loads to the circuit without ensuring that this will not exceed the permissible voltage and current permitted for the equipment in use.
 - Intrinsically safe components are the only types that can be worked on while live in the presence of a flammable atmosphere.
 - The test apparatus shall be at the correct rating.
 - Replace components only with parts specified by the manufacturer. Unspecified parts by manufacturer may result ignition of the refrigerant in the atmosphere from a leak.

- ### 5. Cabling
- Check that cabling will not be subject to wear, corrosion, excessive pressure, vibration, sharp edges or any other adverse environmental effects.
 - The check shall also take into account the effects of aging or continual vibration from sources such as compressors or fans.

- ### 6. Detection of flammable refrigerants
- Under no circumstances shall potential sources of ignition be used in the searching or detection of refrigerant leaks.
 - A halide torch (or any other detector using a naked flame) shall not be used.
 - The following leak detection methods are deemed acceptable for all refrigerant systems.
 - No leaks shall be detected when using detection equipment with a sensitivity of 5 grams per year of refrigerant or better under a pressure of at least 0.25 times the maximum allowable pressure (>1.04MPa, max 4.15MPa) for example, a universal sniffer.
 - Electronic leak detectors may be used to detect flammable refrigerants, but the sensitivity may not be adequate, or may need re-calibration. (Detection equipment shall be calibrated in a refrigerant-free area.)
 - Ensure that the detector is not a potential source of ignition and is suitable for the refrigerant used.
 - Leak detection equipment shall be set at a percentage of the LFL of the refrigerant and shall be calibrated to the refrigerant employed and the appropriate percentage of gas (25 % maximum) is confirmed.
 - Leak detection fluids are also suitable for use with most refrigerants, for example, bubble method and fluorescent method pipes-work. The use of detergents containing chlorine shall be avoided as the chlorine may react with the refrigerant and corrode the copper pipe-work.
 - If a leak is suspected, all naked flames shall be removed/extinguished.
 - If a leakage of refrigerant is to have which requires brazing, all of the refrigerant shall be recovered from the system, or isolated (by means of shut off valves) in a part of the system remote from the leak. The precautions in #7 must be followed to remove the refrigerant.

- ### 7. Removal and evacuation
- When breaking into the refrigerant circuit to make repairs - or for any other purpose - conventional procedures shall be used. However, it is important that best practice is followed since flammability is a consideration. The following procedure shall be adhered to:
 - Remove refrigerant -> purge the circuit with inert gas -> evacuate -> purge with inert gas -> open the circuit by cutting or brazing
 - The refrigerant charge shall be recovered into the correct recovery cylinders.
 - The system shall be purged with OFN to render the appliance safe. (remark: OFN = oxygen free nitrogen, type of inert gas) This process may need to be repeated several times.
 - Compressed air or oxygen shall not be used for this task.
 - Purging shall be achieved by breaking the vacuum in the system with OFN and continuing to fill until the working pressure is achieved, then venting to atmosphere, and finally pulling down to a vacuum.
 - This process shall be repeated until no refrigerant is within the system.
 - When the final OFN charge is used, the system shall be vented down to atmospheric pressure to enable work to take place.
 - This operation is absolutely vital if brazing operations on the pipe work are to take place.
 - Ensure that the outlet for the vacuum pump is not close to any potential ignition sources and there is ventilation available.

- ### 8. Charging procedures
- In addition to conventional charging procedures, the following requirements shall be followed.
 - Ensure that contamination of different refrigerants does not occur when using charging equipment.
 - Hoses or lines shall be as short as possible to minimize the amount of refrigerant contained in them.
 - Cylinders shall be kept in an appropriate position according to the instructions.
 - Ensure that the refrigerating system is earthed prior to charging the system with refrigerant.
 - Label the system when charging is complete (if not already).
 - Extreme care shall be taken not to over fill the refrigerating system.
 - Prior to recharging the system it shall be pressure tested with OFN (refer to #7).
 - The system shall be leak tested on completion of charging but prior to commissioning.
 - A follow up leak test shall be carried out prior to leaving the site.
 - Electrostatic charge may accumulate and create a hazardous condition when charging and discharging the refrigerant. To avoid fire or explosion, dissipate static electricity during transfer by grounding and bonding containers and equipment before charging/discharging.

- ### 9. Decommissioning
- Before carrying out this procedure, it is essential that the technician is completely familiar with the equipment and all its details.
 - It is recommended good practice that all refrigerants are recovered safely.
 - Prior to the task being carried out, an oil and refrigerant sample shall be taken in case analysis is required prior to re-use of recovered refrigerant.
 - It is essential that electrical power is available before the task is commenced.
 - Become familiar with the equipment and its operation.
 - Isolate system electrically.
 - Before attempting the procedure ensure that:
 - mechanical handling equipment is available, if required, for handling refrigerant cylinders;
 - all personal protective equipment is available and being used correctly;
 - the recovery process is supervised at all times by a competent person;
 - recovery equipment and cylinders conform to the appropriate standards.
 - Pump down refrigerant system, if possible.
 - If a vacuum is not possible, make a manifold so that refrigerant can be removed from various parts of the system.
 - Make sure that cylinder is situated on the scales before recovery takes place.
 - Start the recovery machine and operate in accordance with instructions.
 - Do not over fill cylinders. (No more than 80 % volume liquid charge).
 - Do not exceed the maximum working pressure of the cylinder, even temporarily.
 - When the cylinders have been filled correctly and the process completed, make sure that the cylinders and the equipment are removed from site promptly and all isolation valves on the equipment are closed off.
 - Recovered refrigerant shall not be charged into another refrigerating system unless it has been cleaned and checked.
 - Electrostatic charge may accumulate and create a hazardous condition when charging or discharging the refrigerant. To avoid fire or explosion, dissipate static electricity during transfer by grounding and bonding containers and equipment before charging/discharging.

- ### 10. Labelling
- Equipment shall be labelled stating that it has been de-commissioned and emptied of refrigerant.
 - The label shall be dated and signed.
 - Ensure that there are labels on the equipment stating the equipment contains flammable refrigerant.

- ### 11. Recovery
- When removing refrigerant from a system, either for servicing or decommissioning, it is recommended good practice that all refrigerants are removed safely.
 - When transferring refrigerant into cylinders, ensure that only appropriate recovery cylinders are employed.
 - Ensure that the correct number of cylinders for holding the total system charge are available.
 - All cylinders to be used are designated for the recovered refrigerant and labelled for that refrigerant (i.e. special cylinders for the recovery of refrigerant).
 - Cylinders shall be complete with pressure relief valve and associated shut-off valves in good working order.
 - Recovery cylinders are evacuated and, if possible, cooled before recovery occurs.
 - The recovery equipment shall be in good working order with a set of instructions concerning the equipment that is at hand and shall be suitable for the recovery of concerning the equipment that is at hand and shall be suitable for the recovery of flammable refrigerants.
 - In addition, a set of calibrated weighing scales shall be available and in good working order.
 - Hoses shall be complete with leak-free disconnect couplings and in good condition.
 - Before using the recovery machine, check that it is in satisfactory working order, has been properly maintained and that any associated electrical components are sealed to prevent ignition in the event of a refrigerant release.
 - Consult manufacturer if in doubt.
 - The recovered refrigerant shall be returned to the refrigerant supplier in the correct recovery cylinder, and the relevant Waste Transfer Note arranged.
 - Do not mix refrigerants in recovery units and especially not in cylinders.
 - If compressors or compressor oils are to be removed, ensure that they have been evacuated to an acceptable level to make certain that flammable refrigerant does not remain within the lubricant.
 - The evacuation process shall be carried out prior to returning the compressor to the suppliers.
 - Only electric heating to the compressor body shall be employed to accelerate this process.
 - When oil is drained from a system, it shall be carried out safely.

Required tools for Installation Works

1 Phillips screw driver	6 Pipe cutter	11 Thermometer	16 Torque wrench
2 Level gauge	7 Reamer	12 Megameter	18 Nm (1.8 kgf/m)
3 Electric drill, hole core drill (ø70 mm)	8 Knife	13 Multimeter	42 Nm (4.3 kgf/m)
4 Hexagonal wrench (4 mm)	9 Gas leak detector	14 Vacuum pump	55 Nm (5.6 kgf/m)
5 Spanner	10 Measuring tape	15 Gauge manifold	65 Nm (6.6 kgf/m)
			100 Nm (10.2 kgf/m)

Attached accessories

No.	Accessories part	Qty.	No.	Accessories part	Qty.
1	Installation plate	1	6	Remote control holder fixing screw	2
2	Installation plate fixing screw	5	7	Drain elbow	1
3	Remote Control	1	8	Air purifying filter	1
4	Battery	2			
5	Remote control holder	1			

Applicable piping kit	Piping size	
	Gas	Liquid
CZ-3F5, 7BP	9.52 mm (3/8")	6.35 mm (1/4")
CZ-4F5, 7, 10BP	12.7 mm (1/2")	6.35 mm (1/4")
CZ-5F5, 7, 10BP	15.88 mm (5/8")	6.35 mm (1/4")

SELECT THE BEST LOCATION

- | | |
|--|--|
| <h4>INDOOR UNIT</h4> <ul style="list-style-type: none"> Do not install the unit in excessive oil fume area such as kitchen, workshop and etc. There should not be any heat source or steam near the unit. There should not be any obstacles blocking the air circulation. A place where air circulates in the room is good. A place where drainage can be easily done. A place where noise prevention is taken into consideration. Do not install the unit near the door way. Ensure the spaces indicated by arrows from the wall, ceiling, fence or other obstacles. Indoor unit of this air conditioner shall be installed in a height of at least 1.8 m. | <h4>OUTDOOR UNIT</h4> <ul style="list-style-type: none"> If an awning is built over the unit to prevent direct sunlight or rain, be careful that heat radiation from the condenser is not obstructed. There should not be any animal or plant which could be affected by hot air discharged. Keep the spaces indicated by arrows from wall, ceiling, fence or other obstacles. Do not place any obstacles which may cause a short circuit of the discharged air. If piping length is over the [piping length for additional gas], additional refrigerant should be added as shown in the (Table A). |
|--|--|

Table A

Model	Capacity (HP)	Piping size		Std. Length (m)	Max. Elevation (m)	Min. Piping Length (m)	Max. Piping Length (m)	Additional Refrigerant (g/m)	Piping Length for add. gas (m)	Max. Refrigerant Charge (kg)	A _{min} (m ²)
		Gas	Liquid								
YU9***	1.0HP	9.52 mm (3/8")	6.35 mm (1/4")	5	15	3	20	10	7.5	0.59	Not applicable (*)
YU12***	1.5HP	9.52 mm (3/8")	6.35 mm (1/4")	5	15	3	20	10	7.5	0.69	Not applicable (*)

Example: For YU9***
If the unit is installed at 10 m distance, the quantity of additional refrigerant should be => 10 m (distance) - 7.5 m (piping length for additional gas) => 2.5 m => 2.5 m x 10 g/m (additional Refrigerant) => 25 g

$A_{min} = (m_r / (2.5 \times (LFL)^{0.66} \times h_o))^2$ ** not less than safety factor margin
 A_{min} = Required minimum room area, in m²
 m_r = Refrigerant charge in appliance, in kg
 LFL = Lower flammability limit (0.307 kg/m³)
 h_o = Installation height of the appliance : (1.8 m for wall mounted)
 SF = Safety factor with a value of 0.75

(*)=> Systems with total refrigerant charge, m_r lower than 1.84 kg are not subjected to any room area requirements.
 ** The required minimum room area, shall also be governed by the safety factor margin formula below :
 $A_{min} = m_r / (SF \times LFL \times h_o)$ The higher value shall be taken when determining the room area.

CAUTION

- ### 1. General
- Must ensure the installation of pipe-work shall be kept to a minimum. Avoid use dented pipe and do not allow acute bending.
 - Ignition is minimized by the physical design of the unit.
 - Must comply with national gas regulations, state municipal rules and legislation.
 - Notify relevant authorities in accordance with all applicable regulations.
 - Must ensure mechanical connections be accessible for maintenance purposes.
 - In cases that require mechanical ventilation, ventilation openings shall be kept clear of obstruction.
 - When disposal of the product, do follow to the precautions in #11 and comply with national regulations.
 - In case of field charge, the effect on refrigerant charge caused by the different pipe length has to be quantified, measured and labelled. Always refer to local municipal offices for proper handling.
 - Ensure the actual refrigerant charge is in accordance with the room size within which the refrigerant containing parts are installed.
 - Ensure refrigerant charge not to leak.
 - Wear appropriate protective equipment, including respiratory protection, as conditions warrant.
 - Keep all sources of ignition and hot metal surfaces away.
- ### 2. Servicing
- #### 2-1. Qualification of workers
- Any qualified person who is involved with working on or breaking into a refrigerant circuit should hold a current valid certificate from an industry-accredited assessment authority, which authorizes their competence to handle refrigerants safely in accordance with an industry recognized assessment specification.
 - Servicing shall only be performed as recommended by the equipment manufacturer. Maintenance and repair requiring the assistance of other skilled personnel shall be carried out under the supervision of the person competent in the use of flammable refrigerants.
 - Servicing shall be performed only as recommended by the manufacturer.
 - The system is inspected, regularly supervised and maintained by a trained and certified service personnel who is employed by the person user or party responsible.
- #### 2-2. Checks to the area
- Prior to beginning work on systems containing flammable refrigerants, safety checks are necessary to ensure that the risk of ignition is minimized.
 - For repair to the refrigerating system, the precautions in #2-3 to #2-7 must be followed before conducting work on the system.
- #### 2-3. Work procedure
- Work shall be undertaken under a controlled procedure so as to minimize the risk of a flammable gas or vapour being present while the work is being performed.
- #### 2-4. General work area
- All maintenance staff and others working in the local area shall be instructed and supervised on the nature of work being carried out.
 - Avoid working in confined spaces. Always ensure away from source, at least 2 meter of safety distance, or zoning of free space area of at least 2 meter in radius.
- #### 2-5. Checking for presence of refrigerant
- The area shall be checked with an appropriate refrigerant detector prior to work and during work, to ensure the technician is aware of potentially flammable atmospheres.
 - Marking that the leak detection equipment being used is suitable for use with flammable refrigerants, i.e. non sparking, adequately sealed or intrinsically safe.
 - In case of leakage/spillage happened, immediately ventilate area and stay upwind and away from spill/release.
 - In case of leakage/spillage happened, do notify persons down wind of the leaking/spill, isolate immediate hazard area and keep unauthorized personnel out.
- #### 2-6. Presence of fire extinguisher
- If any hot work is to be conducted on the refrigerating equipment or any associated parts, appropriate fire extinguishing equipment shall be available at hand.
 - Have a dry powder or CO₂ fire extinguisher adjacent to the charging area.
- #### 2-7. No ignition sources
- No person carrying out work in relation to a refrigerating system which involves exposing any pipe work that contains or has contained flammable refrigerant shall use any source of ignition in such a manner that it may lead to the risk of fire or explosion. He/She must not be smoking when carrying out such work.
 - All possible ignition sources, including cigarette smoking, should be kept sufficiently far away from the site of installation, repairing, removing and disposal of flammable refrigerant can possibly be released to the surrounding space.
 - Prior to work taking place, the area around the equipment is to be surveyed to make sure that there are no flammable hazards or ignition risks.
 - "No Smoking" signs shall be displayed.
- #### 2-8. Ventilated area
- Ensure that the area is in the open or that it is adequately ventilated before breaking into the system or conducting any hot work.
 - A degree of ventilation shall continue during the period that the work is carried out.
 - The ventilation should safely disperse any released refrigerant and preferably expel it externally into the atmosphere.
- #### 2-9. Checks to the refrigerating equipment
- Where electrical components are being changed, they shall be fit for the purpose and to the correct specification.
 - At all times the manufacturer's maintenance and service guidelines shall be followed.
 - If in doubt consult the manufacturer's technical department for assistance.
 - The following checks shall be applied to installations using flammable refrigerants.
 - The actual refrigerant charge is in accordance with the room size within which the refrigerant containing parts are installed.
 - The ventilation machinery and outlets are operating adequately and are not obstructed.
 - If an indirect refrigerating circuit is being used, the secondary circuit shall be checked for the presence of refrigerant.
 - Marking to the equipment continues to be visible and legible. Markings and signs that are illegible shall be corrected.
 - Refrigerating pipe or components are installed in a position where they are unlikely to be exposed to any substance which may corroded refrigerant containing components, unless the components are constructed of materials which are inherently resistant to being corroded or are properly protected against being so corroded.

Indoor/Outdoor Unit Installation Diagram

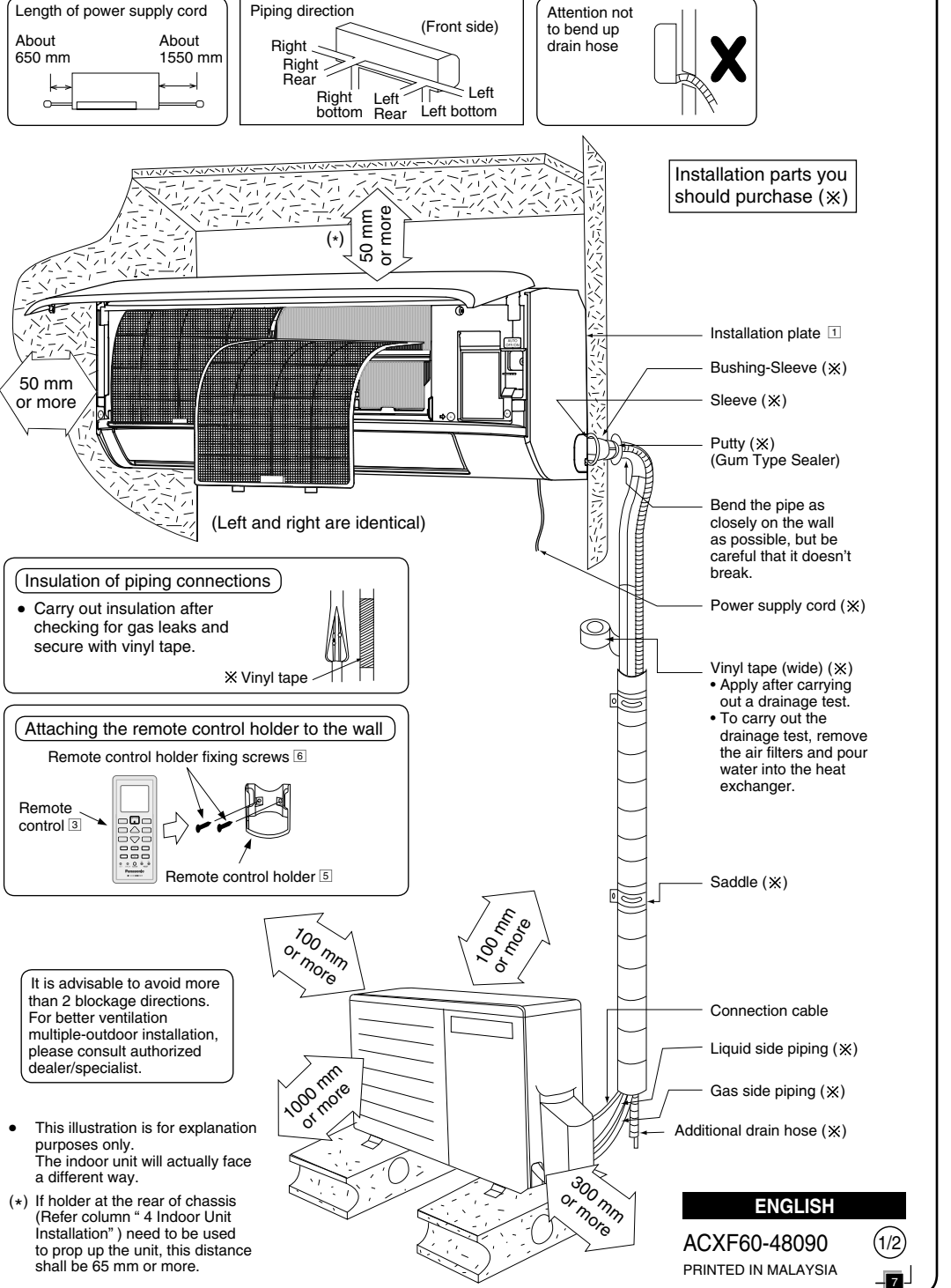

1 SELECT THE BEST LOCATION (Refer to "Select the best location" section)

2 HOW TO FIX INSTALLATION PLATE

The mounting wall shall be strong and solid enough to prevent it from vibration.

Dimension					
1	2	3	4	5	6
465 mm	70 mm (+)	365 mm	415 mm	10 mm	70 mm

• The center of installation plate should be at more than ① at right and left of the wall.
 • The distance from installation plate edge to ceiling should more than ②.
 • From installation plate center to unit's left side is ③.
 • From installation plate center to unit's right side is ④.

⑤ For left side piping, piping connection for liquid should be about ⑤ from this line.
 ⑥ For left side piping, piping connection for gas should be about ⑥ from this line.

3 TO DRILL A HOLE IN THE WALL AND INSTALL A SLEEVE OF PIPING

- Insert the piping sleeve to the hole.
- Fix the bushing to the sleeve.
- Cut the sleeve until it extrudes about 15 mm from the wall.

CAUTION
 When the wall is hollow, please be sure to use the sleeve for tube assembly to prevent dangers caused by mice biting the connection cable.

Finish by sealing the sleeve with putty or caulking compound at the final stage.

4 INDOOR UNIT INSTALLATION

1. FOR THE RIGHT REAR PIPING

- Pull out the Indoor piping
- Install the Indoor Unit
- Secure the Indoor Unit
- Insert the connection cable

2. FOR THE RIGHT AND RIGHT BOTTOM PIPING

- Pull out the Indoor piping
- Install the Indoor Unit
- Insert the connection cable
- Secure the Indoor Unit

3. FOR THE EMBEDDED PIPING

- Change the drain hose position
- Bend the embedded piping
- Pull the connection cable into Indoor Unit
- Cut and flare the embedded piping
- Install the Indoor Unit
- Connect the piping
- Insulate and finish the piping
- Secure the Indoor Unit

5. CONNECT THE CABLE TO THE INDOOR UNIT

- Install the indoor unit on the installing holder that mounted on the wall.
- Open the front panel and grille door by loosening the screw.
- Bind all the indoor and outdoor Connection cable with tape and route the connection cable via the right side escapement.

6 PIPING INSULATION

- Please carry out insulation at pipe connection portion as mentioned in Indoor/Outdoor Unit Installation Diagram. Please wrap the insulated piping end to prevent water from going inside the piping.
- If drain hose or connecting piping is in the room (where dew may form), please increase the insulation by using POLY-E FOAM with thickness 6 mm or above.

7. FOR THE EMBEDDED PIPING

- Change the drain hose position
- Bend the embedded piping
- Pull the connection cable into Indoor Unit
- Cut and flare the embedded piping
- Install the Indoor Unit
- Connect the piping
- Insulate and finish the piping
- Secure the Indoor Unit

8. CHECK THE DRAINAGE

- Open front panel and remove air filters.
- Pour a glass of water into the drain tray-styrofoam.
- Ensure that water flows out from drain hose of the indoor unit.

9. EVALUATION OF THE PERFORMANCE

- Operate the unit at cooling/heating operation mode for fifteen minutes or more.
- Measure the temperature of the intake and discharge air.
- Ensure the difference between the intake temperature and the discharge is more than 8 °C during Cooling operation or more than 14 °C during Heating operation.

10. INSTALLATION OF AIR PURIFYING FILTER/ DUST COLLECTOR FILTER

- Open the front panel.
- Remove the air filters.
- Put the Air Purifying Filter into place as shown in illustration at right.

11. IN CASE OF REUSING EXISTING REFRIGERANT PIPING

Observe the followings to decide reusing the existing refrigerant piping. Poor refrigerant piping could result in product failure.

- The circumstances listed below, do not reuse any refrigerant piping. Instead, make sure to install a new piping.
 - Heat insulation is not provided for either liquid-side or gas-side piping or both.
 - The existing refrigerant pipe has been left in an open condition.
 - The diameter and thickness of the existing refrigerant piping does not meet the requirement.
 - The piping length and elevation does not meet the requirement.
- Perform proper pump down before reuse piping.
- In the circumstances listed below, clean it thoroughly before reuse.
 - Pump down operation cannot be performed for the existing air-conditioner.
 - The compressor has a failure history.
 - Oil color is darkened. (ASTM 4.0 and above).
 - The existing air-conditioner is gas/oil heat pump type.
- Do not reuse the flare to prevent gas leak. Make sure to install a new flare.
- If there is a welded part on the existing refrigerant piping, conduct a gas leak check on the welded part.
- Replace deteriorated heat insulating material with a new one.
- Heat insulating material is required for both liquid-side and gas-side piping.

12. PROPER PUMP DOWN METHOD

- Operate air conditioner at cooling mode for 10 - 15 minutes.
- After 10 - 15 minutes of pre operation, close 2 way valve. After 3 minutes, close 3 way valve.
- Take out air conditioner unit.
- Install new Refrigerant air conditioner.

13. CHECK ITEMS

<input type="checkbox"/> Is there any gas leakage at flare nut connections?	<input type="checkbox"/> Is the indoor unit properly hooked to the installation plate?
<input type="checkbox"/> Has the heat insulation been carried out at flare nut connections?	<input type="checkbox"/> Is the power supply voltage complied with rated value?
<input type="checkbox"/> Is the connection cable being fixed to terminal board firmly?	<input type="checkbox"/> Is there any abnormal sound?
<input type="checkbox"/> Is the connection cable being clamped firmly?	<input type="checkbox"/> Is the cooling/heating operation normal?
<input type="checkbox"/> Is the drainage ok? (Refer to "Check the drainage" section)	<input type="checkbox"/> Is the thermostat operation normal?
<input type="checkbox"/> Is the earth wire connection properly done?	<input type="checkbox"/> Is the remote controller's LCD operation normal?

1 SELECT THE BEST LOCATION (Refer to "Select the best location" section)

2 INSTALL THE OUTDOOR UNIT

Model	A	B	C	D
1.0HP	474 mm	87 mm	18.5 mm	261 mm
1.5HP	570 mm	105 mm	18.5 mm	320 mm

3 CONNECT THE PIPING

Connecting The Piping to Indoor

For connection joint of all models Please make flare after inserting (locate at joint portion of tube assembly) onto the copper pipe.

Connecting The Piping to Outdoor

Decide piping length and then cut by using pipe cutter. Remove burrs from cut edge. Make flare after inserting the flare nut (locate at valve) onto the copper pipe.

Piping size	Torque
6.35 mm (1/4")	18 N·m (1.8 kgf·m)
9.52 mm (3/8")	42 N·m (4.3 kgf·m)
12.7 mm (1/2")	55 N·m (5.6 kgf·m)
15.88 mm (5/8")	85 N·m (8.6 kgf·m)
19.05 mm (3/4")	100 N·m (10.2 kgf·m)

4 CONNECT THE CABLE TO THE OUTDOOR UNIT

- Remove the control board cover from the unit by loosening the screw.
- Connection cable between indoor unit and outdoor unit shall be approved polychloroprene sheathed 4 x 1.5 mm² (1.0 - 1.5HP) flexible cord, type designation 60245 IEC 57 or heavier cord. Do not use joint connection cable. Replace the wire if the existing wire (from concealed wiring, or otherwise) is too short.
- Secure the cable onto the control board with the holder (clammer).
- Attach the control board cover back to the original position with screw.
- For wire stripping and connection requirement, refer to instruction ⑤ of indoor unit.

Earth wire shall be Yellow/Green (Y/G) in colour and longer than other AC wires for safety reason.

5 FRONT GRILLE

HOW TO TAKE OUT FRONT GRILLE

- Open front panel.
- Remove the 3 mounting screws on the front grille as shown in the illustration below.
- Slide the 3 lock knobs on the upside of front grille to unlock position.
- Pull the front grille towards you to remove the front grille.

AUTO SWITCH OPERATION

The below operations will be performed by pressing the "AUTO" switch.

- AUTO OPERATION MODE**
The Auto operation will be activated immediately once the Auto Switch is pressed and release within 5 sec..
- TEST RUN OPERATION (FOR PUMP DOWN/SERVICING PURPOSE)**
The Test Run operation will be activated if the Auto Switch is pressed continuously for more than 5 sec. to below 8 sec. A "pep" sound will occur at the fifth sec., in order to identify the starting of Test Run operation.
- REMOTE CONTROLLER RECEIVING SOUND ON/OFF**
The ON/OFF of Remote controller receiving sound can be change over by the following steps:
 a) Press "AUTO" switch continuously for more than 16 sec. to below 21 sec. A "pep", "pep", "pep" sound will occur at the sixteenth sec..
 b) Press the "AC Reset" button once, "pep" sound will occur indicates that Remote controller receiving sound setting mode is activated.
 c) Press "AUTO" switch again. Everytime "AUTO" switch is pressed (within 60 sec. interval), Remote controller receiving sound status will be reversed between ON and OFF. Long "pep" sound indicates that Remote controller receiving sound is ON. Short "pep" sound indicates that Remote controller receiving sound is OFF.

6 DISPOSAL OF OUTDOOR UNIT DRAIN WATER

- If a drain elbow is used, the unit should be placed on a stand which is taller than 5 cm.
- If the unit is used in an area where temperature falls below 0°C for 2 or 3 days in succession, it is recommended not to use a drain elbow, for the drain water freezes and the fan will not rotate.

4 AIR TIGHTNESS TEST ON THE REFRIGERATING SYSTEM

Do not purge the air with refrigerants but use a vacuum pump to vacuum the installation.

There is no extra refrigerant in the outdoor unit for air purging.

- Before system is charged with refrigerant and before the refrigerating system is put into operation, below site test procedure and acceptance criteria shall be verified by the certified technicians, and/or the installer.
- Be sure to check whole system for gas leakage.

4.1 Preparation (Step 1-2)

4.2 Evacuation (Step 3-4)

4.3 Tightness Test with Inert Gas (Step 5-7)

- Connect a charging hose with a push pin to the Low side of a charging set and the service port of the 3-way valve. During extremely cold winter, material contraction might happened, try to further tighten the 2-way, 3-way valve to ensure they are fully closed.
- Attach the gauge manifold set correctly and tightly. Make sure that both valves of the manifold gauge (low pressure and high pressure) is in close position. Then close the low side manifold gauge valve.
- Connect the center hose of the manifold gauge to a vacuum pump.
- Turn on the power switch of the vacuum pump, then turn open the low side manifold gauge valve and make sure that the needle in the gauge moves from 0cmHg (0 MPa) to -76 cmHg (-0.1 MPa) or vacuum until 500 microns is achieved. This process continues for approximately ten minutes.
- Remove the vacuum pump from the centre hose and connect the center hose to cylinder of any applicable inert gas as test gas.
- Charge test gas into the system and wait until the pressure within the system to reach min. 1.04MPa (10.4bar).
- Wait and monitor the pressure reading on the gauges. Check if there is any pressure drop. Waiting time depends on the size of the system.
- If there is any pressure drop, perform step 9-12. If there is no pressure drop, perform step 13.
- Use Gas Leak Detector to check for leaks. Must use the detection equipment with a sensitivity of 5 grams per year of test gas or better.
- Move the probe along the air conditioning system to check for leaks, and mark for repair.
- Any leak detected and marked shall be repaired.
- After repair, repeat evacuation steps 3-4 and tightness test steps 5-7. Check the pressure drop as in step 8.

4.4 Recovery of Test Gas (Step 13)

4.5 Evacuation (Step 3-4)

4.6 Open 2 and 3 valves (Step 14-16)

4.7 Complete

7 CUTTING AND FLARING THE PIPING

- Please cut using pipe cutter and then remove the burrs.
- Remove the burrs by using reamer. If burrs is not removed, gas leakage may be caused. Turn the piping end down to avoid the metal powder entering the pipe.
- Please make flare after inserting the flare nut onto the copper pipes.

8 CHECK THE DRAINAGE

- Open front panel and remove air filters.
- Pour a glass of water into the drain tray-styrofoam.
- Ensure that water flows out from drain hose of the indoor unit.

9 EVALUATION OF THE PERFORMANCE

- Operate the unit at cooling/heating operation mode for fifteen minutes or more.
- Measure the temperature of the intake and discharge air.
- Ensure the difference between the intake temperature and the discharge is more than 8 °C during Cooling operation or more than 14 °C during Heating operation.

10 INSTALLATION OF AIR PURIFYING FILTER/ DUST COLLECTOR FILTER

- Open the front panel.
- Remove the air filters.
- Put the Air Purifying Filter into place as shown in illustration at right.

11 IN CASE OF REUSING EXISTING REFRIGERANT PIPING

Observe the followings to decide reusing the existing refrigerant piping. Poor refrigerant piping could result in product failure.

- The circumstances listed below, do not reuse any refrigerant piping. Instead, make sure to install a new piping.
 - Heat insulation is not provided for either liquid-side or gas-side piping or both.
 - The existing refrigerant pipe has been left in an open condition.
 - The diameter and thickness of the existing refrigerant piping does not meet the requirement.
 - The piping length and elevation does not meet the requirement.
- Perform proper pump down before reuse piping.
- In the circumstances listed below, clean it thoroughly before reuse.
 - Pump down operation cannot be performed for the existing air-conditioner.
 - The compressor has a failure history.
 - Oil color is darkened. (ASTM 4.0 and above).
 - The existing air-conditioner is gas/oil heat pump type.
- Do not reuse the flare to prevent gas leak. Make sure to install a new flare.
- If there is a welded part on the existing refrigerant piping, conduct a gas leak check on the welded part.
- Replace deteriorated heat insulating material with a new one.
- Heat insulating material is required for both liquid-side and gas-side piping.

12 PROPER PUMP DOWN METHOD

- Operate air conditioner at cooling mode for 10 - 15 minutes.
- After 10 - 15 minutes of pre operation, close 2 way valve. After 3 minutes, close 3 way valve.
- Take out air conditioner unit.
- Install new Refrigerant air conditioner.

13 CHECK ITEMS

<input type="checkbox"/> Is there any gas leakage at flare nut connections?	<input type="checkbox"/> Is the indoor unit properly hooked to the installation plate?
<input type="checkbox"/> Has the heat insulation been carried out at flare nut connections?	<input type="checkbox"/> Is the power supply voltage complied with rated value?
<input type="checkbox"/> Is the connection cable being fixed to terminal board firmly?	<input type="checkbox"/> Is there any abnormal sound?
<input type="checkbox"/> Is the connection cable being clamped firmly?	<input type="checkbox"/> Is the cooling/heating operation normal?
<input type="checkbox"/> Is the drainage ok? (Refer to "Check the drainage" section)	<input type="checkbox"/> Is the thermostat operation normal?
<input type="checkbox"/> Is the earth wire connection properly done?	<input type="checkbox"/> Is the remote controller's LCD operation normal?

10. INSTALLATION OF AIR PURIFYING FILTER/ DUST COLLECTOR FILTER

- Open the front panel.
- Remove the air filters.
- Put the Air Purifying Filter into place as shown in illustration at right.

11. IN CASE OF REUSING EXISTING REFRIGERANT PIPING

Observe the followings to decide reusing the existing refrigerant piping. Poor refrigerant piping could result in product failure.

- The circumstances listed below, do not reuse any refrigerant piping. Instead, make sure to install a new piping.
 - Heat insulation is not provided for either liquid-side or gas-side piping or both.
 - The existing refrigerant pipe has been left in an open condition.
 - The diameter and thickness of the existing refrigerant piping does not meet the requirement.
 - The piping length and elevation does not meet the requirement.
- Perform proper pump down before reuse piping.
- In the circumstances listed below, clean it thoroughly before reuse.
 - Pump down operation cannot be performed for the existing air-conditioner.
 - The compressor has a failure history.
 - Oil color is darkened. (ASTM 4.0 and above).
 - The existing air-conditioner is gas/oil heat pump type.
- Do not reuse the flare to prevent gas leak. Make sure to install a new flare.
- If there is a welded part on the existing refrigerant piping, conduct a gas leak check on the welded part.
- Replace deteriorated heat insulating material with a new one.
- Heat insulating material is required for both liquid-side and gas-side piping.

12. PROPER PUMP DOWN METHOD

- Operate air conditioner at cooling mode for 10 - 15 minutes.
- After 10 - 15 minutes of pre operation, close 2 way valve. After 3 minutes, close 3 way valve.
- Take out air conditioner unit.
- Install new Refrigerant air conditioner.

13. CHECK ITEMS

<input type="checkbox"/> Is there any gas leakage at flare nut connections?	<input type="checkbox"/> Is the indoor unit properly hooked to the installation plate?
<input type="checkbox"/> Has the heat insulation been carried out at flare nut connections?	<input type="checkbox"/> Is the power supply voltage complied with rated value?
<input type="checkbox"/> Is the connection cable being fixed to terminal board firmly?	<input type="checkbox"/> Is there any abnormal sound?
<input type="checkbox"/> Is the connection cable being clamped firmly?	<input type="checkbox"/> Is the cooling/heating operation normal?
<input type="checkbox"/> Is the drainage ok? (Refer to "Check the drainage" section)	<input type="checkbox"/> Is the thermostat operation normal?
<input type="checkbox"/> Is the earth wire connection properly done?	<input type="checkbox"/> Is the remote controller's LCD operation normal?

14. DISPOSAL OF OUTDOOR UNIT DRAIN WATER

- If a drain elbow is used, the unit should be placed on a stand which is taller than 5 cm.
- If the unit is used in an area where temperature falls below 0°C for 2 or 3 days in succession, it is recommended not to use a drain elbow, for the drain water freezes and the fan will not rotate.

15. FRONT GRILLE

HOW TO TAKE OUT FRONT GRILLE

- Open front panel.
- Remove the 3 mounting screws on the front grille as shown in the illustration below.
- Slide the 3 lock knobs on the upside of front grille to unlock position.
- Pull the front grille towards you to remove the front grille.

AUTO SWITCH OPERATION

The below operations will be performed by pressing the "AUTO" switch.

- AUTO OPERATION MODE**
The Auto operation will be activated immediately once the Auto Switch is pressed and release within 5 sec..
- TEST RUN OPERATION (FOR PUMP DOWN/SERVICING PURPOSE)**
The Test Run operation will be activated if the Auto Switch is pressed continuously for more than 5 sec. to below 8 sec. A "pep" sound will occur at the fifth sec., in order to identify the starting of Test Run operation.
- REMOTE CONTROLLER RECEIVING SOUND ON/OFF**
The ON/OFF of Remote controller receiving sound can be change over by the following steps:
 a) Press "AUTO" switch continuously for more than 16 sec. to below 21 sec. A "pep", "pep", "pep" sound will occur at the sixteenth sec..
 b) Press the "AC Reset" button once, "pep" sound will occur indicates that Remote controller receiving sound setting mode is activated.
 c) Press "AUTO" switch again. Everytime "AUTO" switch is pressed (within 60 sec. interval), Remote controller receiving sound status will be reversed between ON and OFF. Long "pep" sound indicates that Remote controller receiving sound is ON. Short "pep" sound indicates that Remote controller receiving sound is OFF.

16. DISPOSAL OF OUTDOOR UNIT DRAIN WATER

- If a drain elbow is used, the unit should be placed on a stand which is taller than 5 cm.
- If the unit is used in an area where temperature falls below 0°C for 2 or 3 days in succession, it is recommended not to use a drain elbow, for the drain water freezes and the fan will not rotate.

Panasonic

安裝說明

空調器

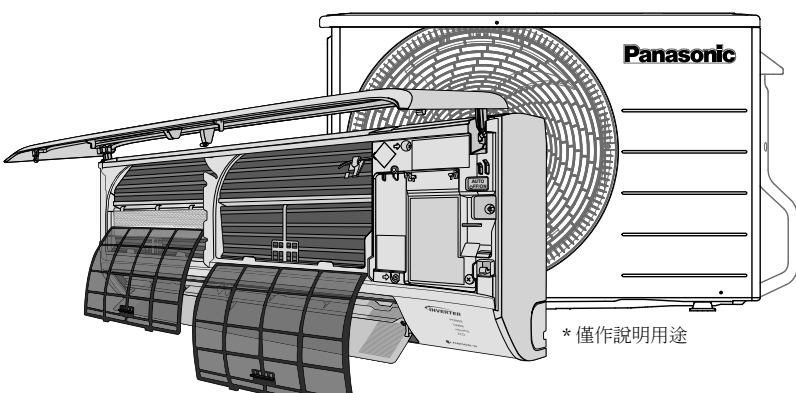

* 僅作說明用途

型號：**CS/CU-YU9*** (1.0HP)**
CS/CU-YU12* (1.5HP)**

室內機或室外機顯示的符號說明。	
	警告 這符號顯示這個設備使用了一種較容易的冷媒。如果冷劑與外部點火源一起洩漏，則有可能引起火。
	注意 這個符號表示應該仔細閱讀安裝手冊。
	注意 此符號表示檢修人員應參照“安裝手冊”處理此設備。
	注意 此符號表示操作手冊和或安裝手冊中包含了信息。

注意

R32 冷媒

此空氣調節機包含 R32 冷劑並利用 R32 冷劑進行操作。

須由具備資質的 R32 冷劑進行安裝或維修。

對此產品進行安裝、保養和維修之前，請參閱國家、州、地區和地方法律、條例、法規、安裝和調作手冊。

安全措施

- 安裝之前請仔細閱讀此“安全措施”。
- 電氣工作必須由技職工人安裝。請務必使用有正確額定電壓的插頭與主電路。
- 請務必遵照所述注意事項，因為其重要內容與您的安全息息相關。各行標的注意事項如下。忽視指示或安裝不當，可能會導致受傷或損壞。其嚴重程度如下所示。

符號	警告	此符號表示可能導致死亡或重傷。	應遵照的注意事項	符號	白色底的符號表示被禁止的項目。
	注意	此符號表示可能只導致受傷或機件損壞。	目的為以下符號分類：		深色底的符號表示必須進行的項目。

如果將設備轉讓給新用戶或交付給回收工廠，請務必同時轉交手冊。

警告

- 除非製造商推薦，否則切勿使用工具加速除霜過程或進行清理。任何不適當的方法或使用不適當的材料可能導致產品損壞、破裂和嚴重損傷。
- 不要將室外機安裝在靠近陽臺的扶手。當在高樓的陽臺安裝空氣調節機時，必須注意小孩可能會爬上室外機並爬出扶手，繼而導致意外發生。
- 勿使用非指定電纜、改裝電纜、接駁電纜或延長電纜作為電源電纜。勿與其他電器共用一個插頭。接觸不良、絕緣不良或電流超額將導致觸電或火災。
- 切勿用帶子將電源電纜繫成一捆。
- 電源電纜可能會異常升溫。
- 切勿將您的手指或其他物體插入本機，高速轉動的風扇可能會導致損傷。
- 切勿坐或踩踏在本機上以免意外摔跤。
- 將膠膠袋（包裝材料）遠離小孩，它可能會粘附在鼻子和嘴巴導致窒息。
- 當安裝或重新安裝空氣調節機時，除指定冷劑外，勿讓任何物體，例如空氣等，混入製冷循環系統（導管）。空氣等的加入將導致製冷循環系統出現異常高壓並導致爆炸、受傷等等。
- 切勿刺穿或燒燒，因為本設備已加壓。切勿觸碰接線端高壓、明火、火花或其他點火源。否則，可能發生爆炸，導致受傷或死亡。
- 切勿添加或更換指定類型以外的冷劑。這可能會導致產品損壞、破裂、損傷等。

- 對於 R32/R410A 模型，請使用 R32/R410A 冷劑所指定的導管、擴口螺母及工具。使用現有的 (R22) 導管、擴口螺母及工具可能會導致 (R32) 冷劑出現不尋常高壓，並可能造成爆炸和受傷。
- 對於 R32 和 R410A，可使用同樣的室外機擴口螺母和導管。
- 由於 R32/R410A 的工作壓力高於冷劑 R22 型號的工作壓力，因此建議更換室外機時的常規導管和擴口螺母。
- 如果不得重新使用導管，請參閱指示“在重新使用現有冷劑配管的情況下”。
- 使用於 R32/R410A 的銅管厚度必須超過 0.8 mm 千萬不要使用厚度低於 0.8 mm 的銅管。
- 殘油的數量最好低於 40 mg/10 m。
- 僱用授權代理商或專人代為安裝。
- 如果用戶自行安裝不正確，將會引起漏水、觸電或火患。
- 製冷系統作業時，應嚴格按照本安裝說明進行安裝。安裝不得法將會引起漏水、觸電或火患。
- 安裝時務請使用所列之附送或指定之配件。否則這將導致本機故障、漏水、火災或觸電。
- 安裝于堅硬和牢固得足以支撐空氣調節機之重量的位置。如果堅固度不足或安裝不得法，空氣調節機將會掉下和致傷人。
- 應遵循國家法規、法律及本安裝說明手冊進行電氣作業。一定要使用獨立電路和單一出口。若電路容量不夠或電線安裝出錯，會導致觸電或火患。
- 勿使用接駁電纜為室內/室外連接電纜。使用特定的室內/室外連接電纜，請參閱指示 ④ **如何將電纜連接至室內機**，並將室內/室外連接緊密地連接好。夾緊電纜，使外力對端子無效。若銜接和安裝不妥，會導致銜接處發熱或產生火患。
- 電線排列須妥當安排，以避免暴露控制板蓋。如果控制板蓋沒有完全地蓋好，它可能會導致火災或觸電。
- 強力建議為此設備安裝靈敏度 30 毫安/0.1 秒或以下的通地線漏電斷路器 (ELCB) 或殘餘電流裝置 (RCD)，否則，當設備故障或絕緣故障等情況發生時可能會導致觸電或火患。

- 進行安裝時，請在啟動壓縮機前妥善地安裝冷劑導管。在沒有安裝冷劑導管和將閥設置在開放位置的情況下操作壓縮機將會導致空氣被吸入、製冷循環系統出現異常高壓並導致爆炸、受傷等等。
- 進行抽氣操作時，請在拆除冷劑導管之前關閉壓縮機。在壓縮機正在操作和閥在開放狀態的情況下拆除冷劑導管將會導致空氣被吸入、製冷循環系統出現異常高壓並導致爆炸、受傷等等。
- 根據所設定的方法使用扭力扳手緊接接頭螺絲。如果將接頭螺絲鎖得太緊，經過一段時間後，接頭螺絲可能會爆裂和導致冷劑洩漏。
- 安裝完畢後，請確定沒有冷劑洩漏。冷劑一旦和火接觸可能會產生有毒氣體。
- 若在操作期間發生冷劑洩漏，請立刻進行通風。冷劑一旦和火接觸可能會產生有毒氣體。
- 應意識到冷劑不得有氣味。

8. 充填步驟

- 除常規充填步驟外，應遵循以下要求：
 - 應在充填設備時，確保不會出現不同冷劑的污染物。
 - 導管或管道儘量可短，以將管道中所包含之冷劑的數量減至最小。
 - 應依照說明書將銅瓶存放於適當位置。
 - 為系統充填冷劑之前，應確保製冷系統正確接地。
 - 充填完成時，請為系統添加標籤（若无標籤）。
 - 應務必小心不要過度充填製冷系統。
- 再充填系統之前，應使用無氣漏測試系統之壓力（參閱第 7 部分）。
- 充填完成時，應在試運轉之前進行漏氣檢查。
- 離開安裝地點之前應進行後續漏氣檢查。
- 充氣和排氣冷劑時，靜電荷可能累積并構成危險情況。在充填/排氣之前，應使容器和設備安全接地，在輸送過程中消除靜電，以避免火災或爆炸。

9. 停用

- 執行此程式之前，技術人員須十分熟悉本設備及其全部詳情。
- 建議遵循良好作業規範，所有冷劑均應安全回收。
- 在執行此項任務之前，應提取回收機油和冷劑銅樣本，以防再用所回收的冷劑之前需要進行分析。
- 開始此項任務之前須確保電力供應正常。
 - 熟悉本設備及其操作。
 - 確保系統電氣絕緣。
 - 嘗試此程式之前應確保：
 - 必要時，備有可供使用的搬置裝備，用於搬運冷劑銅瓶；
 - 備有所有個人防護設備并應正確使用；
 - 回收過程始終要在勝任人員的監督之下；
 - 回收設備和銅瓶符合適當的標準。
- 如有可能，為冷劑系統抽真空。
 - 若無法抽出真空，則製作歧管，便於從系統中的各個部分排放冷劑。
 - 在進行回收之前，應確保銅瓶處於磅秤上。
 - 啟動回收機并依照說明書進行操作。
 - 切勿超額抽真空。（液體充填不超過容積的 80%。）
 - 切勿超額抽真空時，靜電荷可能累積并構成危險情況。
 - 當正確抽真空並且完成抽過時，確保立即從安裝地點拆除銅瓶和設備并關閉設備上的所有隔離閥門。
 - 除非經過清潔和檢驗，否則不得將所回收的冷劑再填入另一個製冷系統。
- 充填或排放冷劑時，靜電荷可能累積并構成危險情況。在充填/排放之前，應使容器和設備安全接地，在輸送過程中消除靜電，以避免火災或爆炸。

10. 添加標籤

- 應為設備添加標籤，說明設備已經停用並且冷劑已排空。
- 標籤應當注明日期并簽名。
- 應確保備上貼有標籤，注明設備包含可燃性冷劑。

11. 回收

- 當出於檢修或停用設備之目的從系統排放冷劑時，建議遵循良好作業規範，所有冷劑均應安全排放。
- 當將冷劑輸送至銅瓶中時，應確保只使用適當的冷劑回收銅瓶。
- 應確保備有適當數量的銅瓶，便於容納整個系統內充填的冷劑。
- 待使用之所有銅瓶被指定用於回收的冷劑并為該冷劑添加標籤（即，用於冷劑回收的特殊銅瓶）。
- 銅瓶應有處於正常狀態的洩壓和相關閥門。
- 為回收銅瓶抽真空，如有可能，在進行回收之前卸回收銅瓶。
- 回收設備處於正常狀態，并隨附關於該設備的一系列說明，回收設備還應適合於回收可燃性冷劑。
- 此外，應備有一臺經過程準且處於正常狀態的磅秤。
- 導管應配有無洩漏快速接頭且處於良好狀態。
- 使用回收機之前，應檢查回收機是否處於正常狀態，已進行正確維護且任何關聯的電氣部件皆已密封，以防冷劑洩漏時發生引燃。
- 如有疑問，請諮詢製造商。
- 應使用正確的回收瓶時所回收的冷劑還運至冷劑供應商處，并提供相關廢棄物轉移說明。
- 切勿在回收裝置中混合冷劑。尤其不要在銅瓶中混合冷劑。
- 如欲拆卸壓縮機或排放壓縮機油，應確保將其排放至可接收水準，確保潤滑油中不含可燃性冷劑。
- 將壓縮機運至指定地點之前，應執行抽真空過程。
- 僅對壓縮機機體進行電熱，以加速此過程。
- 當從系統中排放壓縮機油時，應安全進行。

- 此設備必須正確地接地。地線不可以被連接到煤氣管、水管、避雷針線和電話線地線。否則，當設備故障或絕緣故障等情況發生時可能會導致觸電。

注意

- 勿將空氣調節機安裝於易燃氣體可能滲漏之處。氣體滲漏和積存於空氣調節機周圍可能會引起火患。
- 防止液體或蒸汽進入污水坑或下水道，因為蒸汽比空氣重，可能形成窒息氣氛。
- 進行喉管工作、重新安裝和維修冷操作時不要放出冷劑。
- 小心處理液體製冷劑，它可能會導致凍傷。
- 請勿安裝本裝置於洗衣房或其他有水自天花板等滴落之處。
- 切勿觸碰尖銳的鉛酸熱片以免受到尖銳部件傷害。
- 依照安裝說明書安排排水管。
- 排水管若安裝不當，水滴可能會弄濕房間和損壞家具。
- 選擇容易進行維修工作的安裝位置。此空氣調節機安裝、檢修或維修不當可能增加破裂的風險，因而可能導致損失、損壞或受傷或財物損失。
- 室內空氣調節機的電源銜接。
 - 請使用電線線 3 x 1.5 mm² (1.0 - 1.5HP) 類型名稱 60245 IEC 57 或更粗的電線線。
 - 用以下其中一種方法將空調器的電源電纜連接到總線。電線應該位於容易接近的地方以便在發生緊急事件時可以容易地切斷電源。
 - 某些國家禁止空氣調節機永久性銜接電源供應。
 - 用電插頭塞入插孔以銜接電源。
 - 用有地線的合格 15/16A (1.0 - 1.5HP) 電插頭塞入插孔以連接電源。
 - 將電源永久性銜接到電流切割器。
 - 用合格 16A (1.0 - 1.5HP) 電流切割器進行永久 連接，而且至少有 3.0 mm 空隙的雙極開關。
- 安裝工作。安裝工作可能動用兩人。
- 確保所有通風口保持暢通無阻。

使用 R32 冷劑劑注意事項

- 請密切注意以下幾點和安裝工作程序。

警告

- 本設備應儲存、安裝并工作於通風良好的空間內，室內面積應大於 A_{min} (參見表 A) 並且不存在任何連續操作的點火源。遠離明火、任何工作中的燃氣設備或任何工作中的電熱器。否則，可能發生爆炸，導致受傷或死亡。
- 禁止在系統內混合不同的冷劑。為安全起見，使用 R32 和 R410A 冷劑的型號具有不同的充填端口螺紋直徑，以防錯誤充填 R22 冷劑。
- 因此，應專車檢查。[R32 和 R410A 的充填端口螺紋直徑為 12.7 mm (1/2 英寸)。]
- 確保無異物（油、水等）進入導管。
- 而且，當儲存導管時，應通過夾緊、黏貼等方式緊密封閉管口。（R32 之操作與 R410A 相似。）
- 操作、維護、修理以及冷劑回收應根據製造商的建議，由使用可燃性冷劑方面經過培訓和認證的人員處理。在設備的系統或相關部分上進行操作、維修或維護的任何人員都應該經過培訓和認證。
- 製冷迴路（蒸發器、空氣調節器、AHU、冷凝器或液體接收器）或管道的任何部位不應位於熱源、明火、操作熱氣器具或工作中的電熱器附近。
- 用戶/所有者或授權代表應按照國家規定的要求，至少定期每半年檢查一次報警器、機械通風器和探測器並確保其正確運作。
- 應該保持日記更新。檢查結果應記錄在日記中。
- 應檢查佔用空間內的通風情況，並確認沒有腐蝕物。
- 在使用新的製冷系前，負責系統運行者應確保經過培訓和認證的操作人員根據說明手冊對冷劑系統進行施工、監理、運行和維護，以及要遵守所有安全措施，以及所使用的冷劑的特性及處理。
- 培訓和認證人員的一般要求如下：
 - 了解有關可燃性冷劑的立法、法規和標準，以及；
 - 瞭解有關可燃性冷劑、個人防護設備、防止冷劑洩漏、處理銅瓶、充電、洩漏偵測、回收和處置方面的詳細知識和技能，以及；
 - 理解有關國家立法、法規和標準的要求，以及；
 - 持續進行定期和進一步的培訓，以確保持續持有專業知識。
- 應妥善安裝佔用空間內的空調器管道，以免操作和維修時造成意外損壞。
- 應採取措施避免冷劑導管發生過度振動或震動。
- 應為保護裝置、製冷管和配件提供良好保護，使其免受不良環境影響（例如，排水管積水和凍結風險或污物和碎屑堆積風險）。
- 製冷系統長管道的膨脹與收縮應妥善設計並安裝平閥（安裝妥當和保護），盡可能將液體衝擊對系統造成損壞的可能性降至最低。
- 應妥善保護製冷系統，避免因移動家具或重建活動等而發生意外破裂。
- 應對室內整體牆面製冷管管接頭進行氣密性測試，確保洩漏。在至少 0.25 倍於最大容許壓力的壓力 (>1.04MPa，最大 4.15MPa) 下，該測試方法應具備有每年 5 克冷劑或更好的靈敏度。不應應用洩漏。

安裝時所需的工具			
1 菲力螺絲起子	6 剪管器	11 溫度計	16 扭力扳手
2 水平儀	7 擴孔器	12 高阻表	18 Nm (1.8 kgf·m)
3 電鑽，空心鑽（直徑 Ø70 mm）	8 刀	13 萬用電表	42 Nm (4.3 kgf·m)
4 六角扳手（4 mm）	9 漏氣偵查器	14 真空泵	55 Nm (5.6 kgf·m)
5 扳手	10 帶尺	15 量規歧管	65 Nm (6.6 kgf·m)
			100 Nm (10.2 kgf·m)

附送之配件	
編號	數量
1 安裝板	1
2 安裝板固定螺絲	5
3 遙控器	1
4 電池	2
5 遙控器支架	1
6 遙控器支架固定螺絲	2
7 排水彎管	1
8 空氣淨化過濾器	1

通用的導管套件	配管尺寸	
	氣體	液體
CZ-3F5, 7BP	9.52 mm (3/8")	6.35 mm (1/4")
CZ-4F5, 7, 10BP	12.7 mm (1/2")	6.35 mm (1/4")
CZ-52F5, 7, 10BP	15.88 mm (5/8")	6.35 mm (1/4")

選擇最佳位置

室內機	室外機
<ul style="list-style-type: none"> 切勿將機組安裝到油煙過多的區域，如：廚房、車間等。 機組附近應沒有任何熱源和蒸氣。 不應有任何阻礙空氣流通的障礙物。 最好安裝于空氣流通的地方。 最好安裝于可經完成排水的地方。 最好安裝于有障礙物在內的地方。 切勿將機組安裝在靠近門道的地方。 確保前頭所示之部位離開牆壁、天花板、籬笆或其他阻礙物一段距離。 切勿將機組安裝在靠近門道的地方。 確保前頭所示之部位離開牆壁、天花板、籬笆或其他阻礙物一段距離。 本空調機室內機最低安裝高度應為 1.8 m。 	<ul style="list-style-type: none"> 如果造一個天棚保護室外機組以防止陽光直射或雨淋時，則應注意冷凝器的散熱不受阻礙。 安裝場所不要與養動物和種植花木，因為排出的熱氣對它們有影響。 確保前頭所示之部位離開牆壁、天花板、籬笆或其他阻礙物一段距離。 切勿將機組安裝在靠近門道的地方。 確保前頭所示之部位離開牆壁、天花板、籬笆或其他阻礙物一段距離。 若導管長度超過 [附加氣體的導管長度]，則必須如 (表 A) 所示添加額外的冷劑。

表 A

型號	容量 W (HP)	配管尺寸	標準長度 (m)	最大高度 (m)	最小管子長度 (m)	最大管子長度 (m)	補充冷劑 (g/m)	附加氣體所需的導管長度 (m)	最大冷劑充注量 (kg)	A _{min} (m ²)	
YU9***	1.0HP	9.52 mm (3/8")	6.35 mm (1/4")	5	15	3	20	10	7.5	0.59	不適用 (*)
YU12***	1.5HP	9.52 mm (3/8")	6.35 mm (1/4")	5	15	3	20	10	7.5	0.69	不適用 (*)

舉例：針對 YU9***

若機組的安裝距離是 10 m，額外冷劑的數量應該是

=> 10 m (距離) - 7.5 m (附加氣體的導管長度)

=> 2.5 m

=> 2.5 m x 10 g/m (附加冷劑) => [25 g]

A_{min} = (m_c / (2.5 x (LFL)^{0.81} x h₀))² ** 不小於安全係數

A_{min} = 所需最小房間面積 (m²)

m_c = 設備內冷劑充注量 (kg)

LFL = 燃燒下限 (0.307 kg/m³)

h₀ = 設備的安裝高度：(壁掛式 1.8 m)

SF = 安全係數值 0.75

** 所需最小房間面積，A_{min} 還應遵循下方的安全係數公式：

(*)=> 總冷劑充注量 m_c 低於 1.84 kg 的系統不受任何房間面積要求限制。

A_{min} = m_c / (SF x LFL x h₀) 確定房間面積時應取較大值。

注意

1. 一般

- 必須確保管件的安裝應保持在最低限度。避免使用凹進的管道，不容許存在銳角彎曲。
- 必須確保管件免受實體損傷。
- 必須遵循國家法規、城市政規定和法律。
- 應限期所有適用法規通知有關當局。
- 必須確保機組連接於進行保養。
- 若需要機械維護，則通風口處不存在障礙物。
- 當獲准此產品時，務必遵循第 14 部分中的注意事項并遵循國家法規。
- 由不同管徑長度造成的冷劑充注必須量化、測量和標記。
- 確保實際冷劑充注容量視含冷劑部分所安裝之空間的大小而定。
- 確保冷劑充注不洩漏。
- 倘若條件允許，應佩戴適當的防護設備，包括呼吸防護器。
- 應遠離所有點火源和熱金屬表面。

2. 檢修

- 1. 工作人員資格**
 - 參與冷劑迴路工作或介入冷劑迴路的任何具備資質的人員均應持有由行業認可之評估機構頒發的當前有效憑證，該評估機構授權他們有能力依照業內公認的評估規範安全操作冷劑。
 - 必須按照設備製造商的建議進行檢修。需要其他熟練技術人員協助的保養和維修工作應當在能夠勝任可燃性冷劑使用的人員之監督下進行。
 - 必須按照製造商的建議進行檢修。
 - 系統由受僱於該用戶或負責人的經過培訓和認證的檢修人員進行進行檢查、定期監督和維護。
- 2. 檢查該區域**

- 1. 開始**
 - 開始在包含可燃性冷劑的系統上作業之前，必須進行安全檢查，以確保將引燃之風險降至最低。
 - 對製冷系統進行維修時，開始在系統上作業之前，必須遵循第 2-3 部分至第 2-7 部分的注意事項。
- 2. 作業程序**

- 1. 應按照可控的程式進行作業，以便將工作期間存在可燃氣體或蒸汽的風險降至最低。**
- 2.4 一般作業區域**

- 1. 應當將所進行作業之性質告知在該區域內作業的所有看護人員和其他人員并予以監督。**
- 2.5 檢查是否存在冷劑**

- 1. 在作業之前及作業過程中，應使用適當的冷劑偵測器檢查該區域，確保技術人員知曉潛在的易燃空氣。**
- 2.6 備有滅火器**

- 1. 確保所使用的洩漏偵測設備適用於可燃性冷劑，保持無火花、充分密封或本質安全。**
- 2.7 無點火源**

- 1. 如果發生洩漏/溢漏，應立即為該區域進行通風，保持逆風并遠離洩漏/溢漏。**
- 2.8 通風區域**

- 1. 如果發生洩漏/溢漏，應通知洩漏/溢漏順風方向之人員，立即隔離危害區域，非授權人員不得進入該區域。**
- 2.9 製冷設備檢查**

- 1. 應設置“禁止吸煙”標誌。**
- 2. 通風區域**

- 1. 介入該系統或進行任何高溫作業之前，應確保該區域寬敞或充分通風。**
- 2. 應進行作業時應保持一定的通風。**
- 2.10 應確保能夠安全分散任何洩漏的冷劑，最好將其驅散至外部環境中。**

室內/室外裝機圖

電源電線長度 約 650 mm 約 1550 mm

導管方向 右 (正面) 右後 右下側 左後 左下側

注意不要將排水管向上彎曲

顧客應購買的安裝零件 (X)

安裝板 (X)

套管襯套 (X)

套管 (X)

油灰 (X) (粘膠密封劑)

背管彎管，使其盡最貼近牆面上，但小心別弄斷它。

電源電纜 (X)

纖維尼龍膠帶 (寬) (X)

包裹之先進行排水試驗。

進行排水試驗時，取下空氣調節器，將水倒入熱交換器。

將遙控器支架固定到牆面上

遙控器 (X)

遙控器支架固定螺絲 (X)

遙控器支架 (X)

電線固定座 (X)

連接電纜

液體側管 (X)

氣體側管 (X)

附加排水管 (X)

障礙方向最好不多於兩個。為實現良好通風與多重戶外安裝，請諮詢授權經銷商/專業人士。

100 mm 或以上

100 mm 或以上

100 mm 或以上

300 mm 或以上

專管連接的隔熱

- 在檢查是否有氣體洩露後，進行隔熱處理並使用纖維尼龍膠帶將其固定。

纖維尼龍膠帶

將遙控器支架固定到牆面上

遙控器 (X)

遙控器支架固定螺絲 (X)

遙控器支架 (X)

電線固定座 (X)

連接電纜

液體側管 (X)

氣體側管 (X)

附加排水管 (X)

障礙方向最好不多於兩個。為實現良好通風與多重戶外安裝，請諮詢授權經銷商/專業人士。

100 mm 或以上

100 mm 或以上

100 mm 或以上

300 mm 或以上

本安裝圖僅用於說明目的。室內機實際上採用不同的方式。

(*) 如需在機箱後部使用支架 (請參閱“4 室內機安裝”)，來支撐機組，則距離應為 65 mm 或以上。

中文

ACXF60-4810

在馬來西亞印刷

1/2

1 選擇最佳位置 (參考“選擇最佳位置”之頁)

2 如何固定安裝板

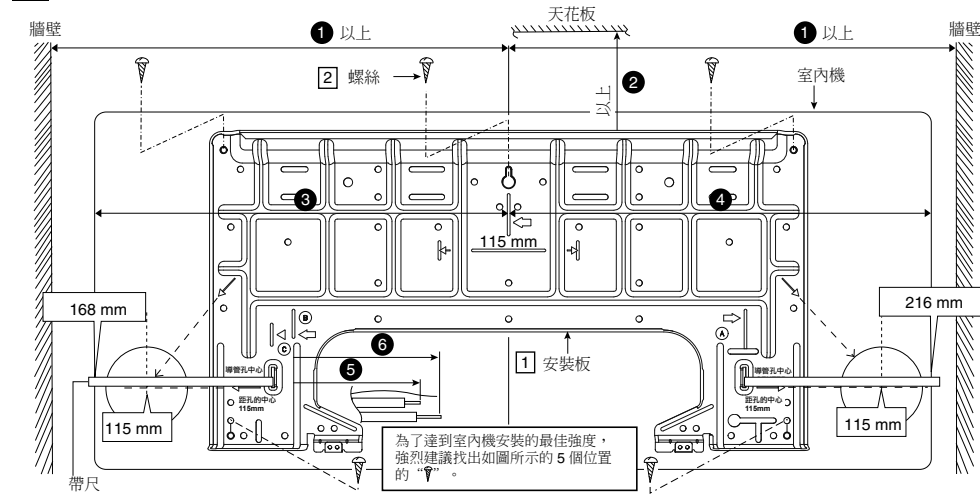

尺寸					
①	②	③	④	⑤	⑥
465 mm	70 mm (+)	365 mm	415 mm	10 mm	70 mm

- 安裝板的中心點到左及右邊牆的距離應大於①。
- 從安裝板邊緣到天花板的距離應大於②。
- 從安裝板中心到本機的左側為③。
- 從安裝板中心到本機的右側為④。
- 至於左邊導管，從這條線起至液體導管連接的距離應約為⑤。
- 至於右邊導管，從這條線起至氣體導管連接的距離應約為⑥。

- 用5枚或以上的螺絲(至少5枚螺絲)，將安裝板安裝到牆面上。(如果將機組安裝到混凝土牆面上，可考慮使用固定螺絲釘。)
- 務必使用水平儀及細線標記一道劃線，並通過對準該道劃線，以水平方向裝上安裝板。
- 用φ70 mm的空心鑽管穿孔。
- 將安裝板的左側和右側形成一條線，延長線的交點是孔的中心。另一個方法是將卷尺放在上圖所示的位置。測孔的左右兩側距離應為115 mm時即可取得測孔的中心點。
- 右側或左側鑽一個導管孔，該孔應稍偏向室外側傾斜。

3 在牆上鑽孔及安裝導管套管

- 將導管套管插入孔中。
- 為套管裝上機套。
- 切斷套管，讓牆外側留下約15 mm長的套管。

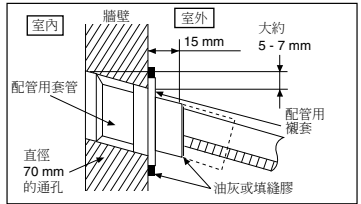

當牆壁為空心結構時，務請使用配有套管，以防止老鼠咬壞連接電纜而導致的危險。

- 最後請用油灰或堵窩劑加密封(在最後階段進行)。

4 室內機的安裝

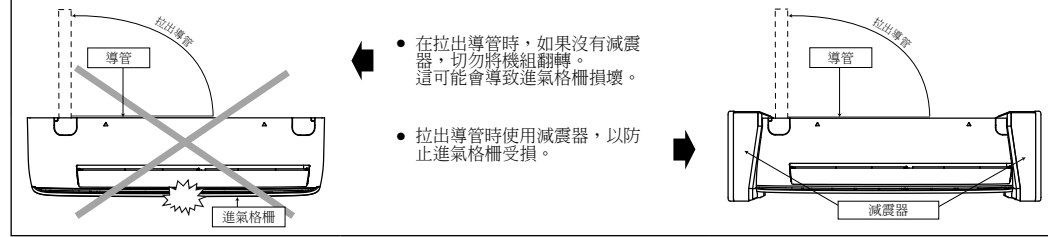

- 右後導管的安裝
 - 拉出室內導管
 - 安裝室內機
 - 固定室內機
 - 若使用室內電源連接，過長的電源電纜必須相應地佈置，請在固定室內機前參閱“電源電纜佈置”。
 - 插入連接電纜

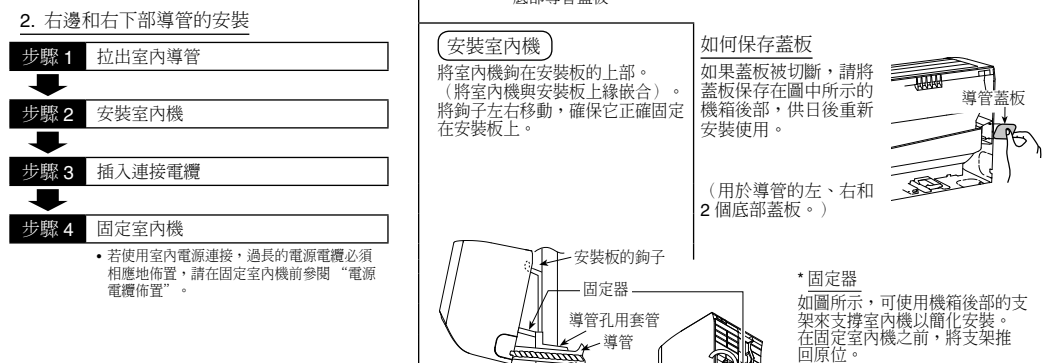

- 右邊和下部導管的安裝
 - 拉出室內導管
 - 安裝室內機
 - 插入連接電纜
 - 固定室內機
 - 若使用室內電源連接，過長的電源電纜必須相應地佈置，請在固定室內機前參閱“電源電纜佈置”。

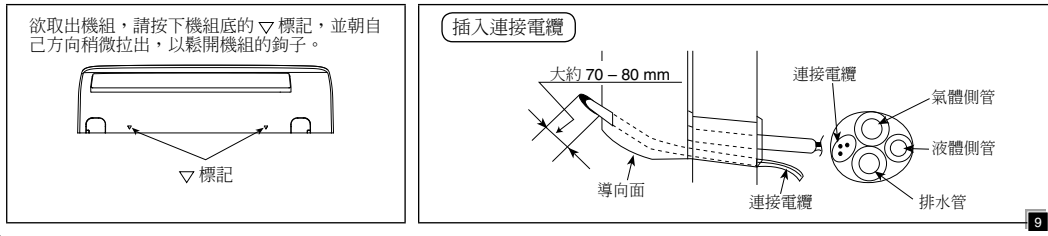

1 選擇最佳位置 (參考“選擇最佳位置”之頁)

2 裝置室外機

- 選定最佳位置後，依照室內/室外機安裝圖進行安裝。
- 用螺絲(φ10 mm 直徑)將室外機穩實打橫地裝在牆上或樑上。確保機組安裝在水平面上，確保水從機組排水孔流出。
- 若裝在屋頂，請考慮到強風和地震。
- 請用螺絲、螺絲釘把安裝框架裝穩。

型號	A	B	C	D
1.0HP	474 mm	87 mm	18.5 mm	261 mm
1.5HP	570 mm	105 mm	18.5 mm	320 mm

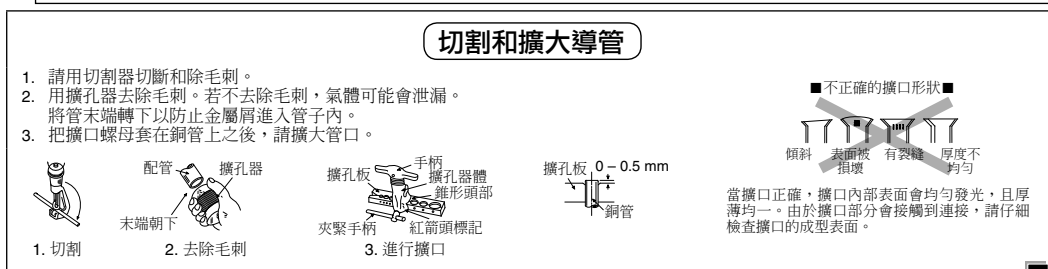
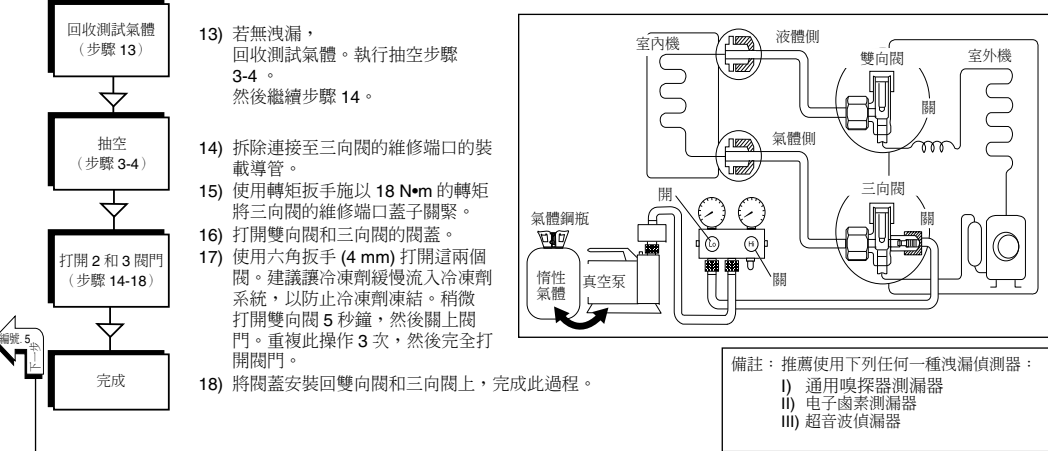
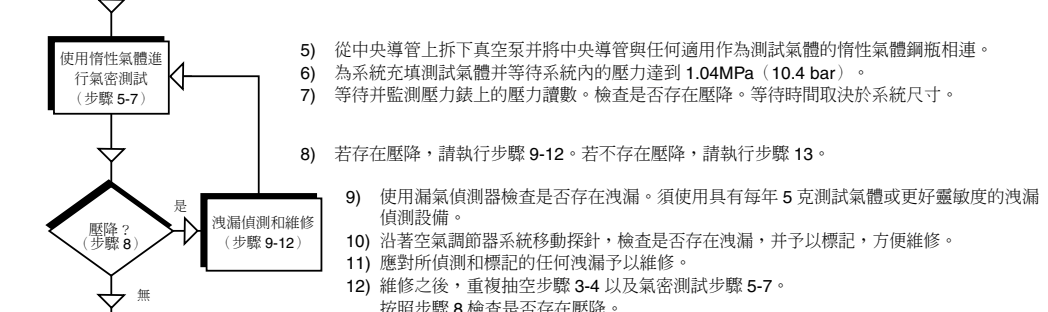

3. 嵌入式配管的處理

- 更改排水管的位置
- 將嵌入式導管弄彎
 - 使用彈簧管或類似的物體弄彎導管，以避免導管被壓壞。
- 引導連接電纜進入室內機
 - 室內和室外機連接電纜可以在不拆除前格柵的情況下進行連接。
- 切割和擴大嵌入式導管
 - 在確定導管尺寸時，將機組滑至安裝板的最左邊。
 - 請參閱“切割和擴大導管”一欄。
- 安裝室內機
- 連接管子
 - 請參閱室外機末端的“連接管子”(連接至外導管和這套氣體並無破損後才執行以下的步驟)。
- 為導管進行隔熱及成型處理
 - 請參閱室內/室外機安裝圖的“導管連接的隔熱”。
- 固定室內機
 - (這適用於左後導管。)

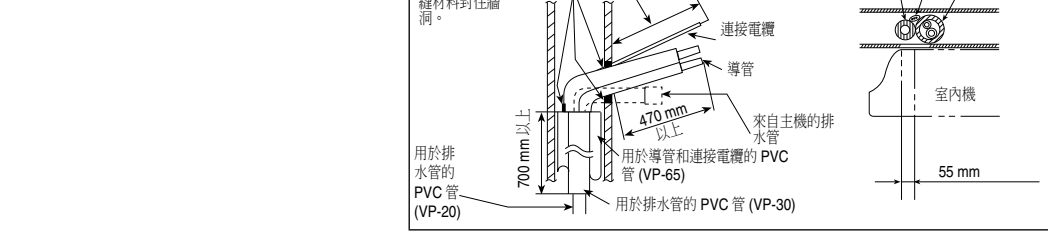

5 將電纜連接至室內機

- 將室內機安裝在裝在牆壁上的安裝支架。
 - 鬆開螺絲然後打開前面板和格柵門。
- 室內和室外的連接電纜應採用被核准的聚氯二烯鎂。4 x 1.5 mm² (1.0 - 1.5HP) 電線(編號 60245 IEC 57)或負荷更高的電線。切勿使用接駁連接電纜。若現有(隱藏配線或其它)電纜太短，請更換之。
- 用膠帶綁起所有室內機和室外機的連接電纜，並將連接電纜繞至左邊出口。



1 選擇最佳位置 (參考“選擇最佳位置”之頁)

2 裝置室外機

- 選定最佳位置後，依照室內/室外機安裝圖進行安裝。
- 用螺絲(φ10 mm 直徑)將室外機穩實打橫地裝在牆上或樑上。確保機組安裝在水平面上，確保水從機組排水孔流出。
- 若裝在屋頂，請考慮到強風和地震。
- 請用螺絲、螺絲釘把安裝框架裝穩。

型號	A	B	C	D
1.0HP	474 mm	87 mm	18.5 mm	261 mm
1.5HP	570 mm	105 mm	18.5 mm	320 mm

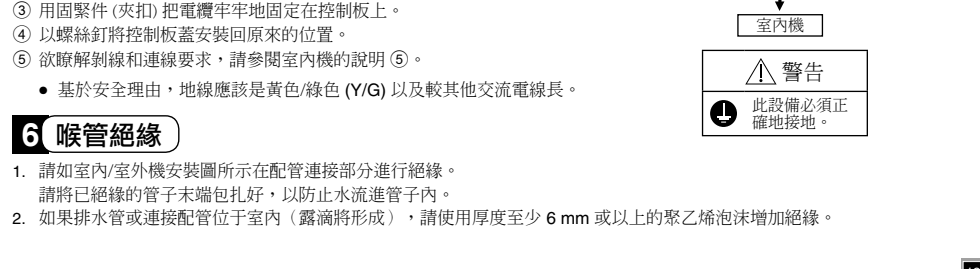
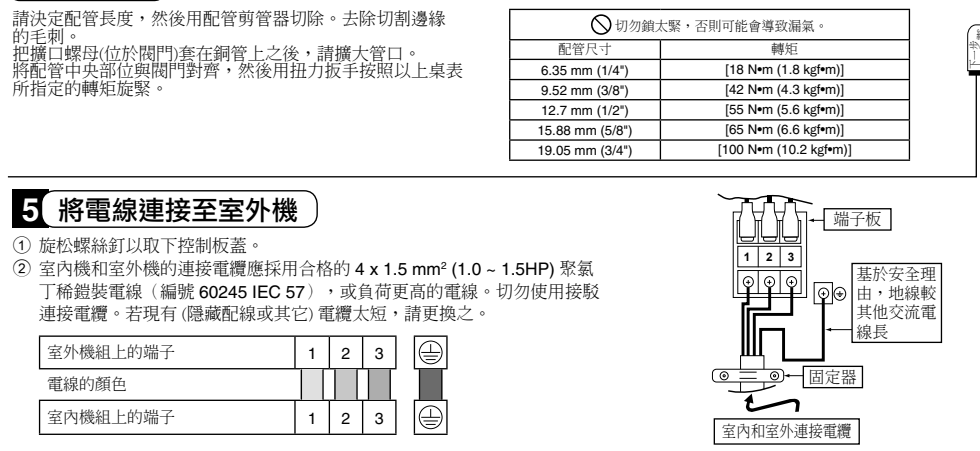
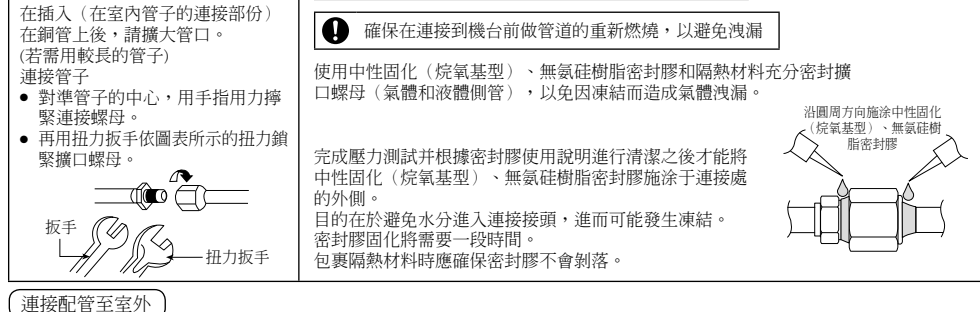

4 製冷系統氣密測試

- 切勿使用冷凍劑排除系統內的空氣，而應使用真空泵為裝置抽真空。
- 室外機內不存在額外冷劑用於排除空氣。
- 在為系統充填冷劑之前以及製冷系統投入工作之前，應由經認證的技術人員和/或安裝工對下方現場測試程序和驗收準則予以核實。
- 請務必檢查整個系統是否存在氣體洩漏。

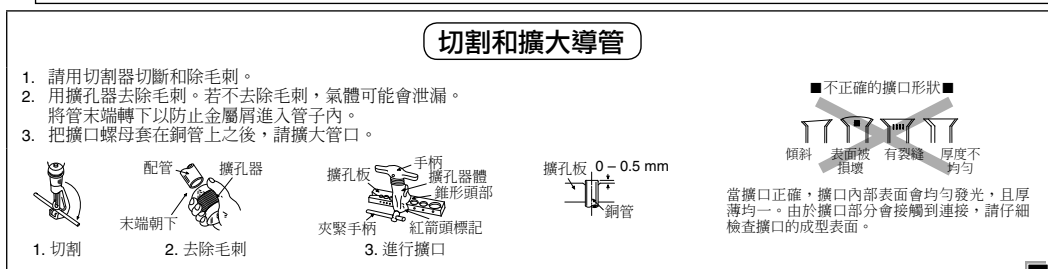
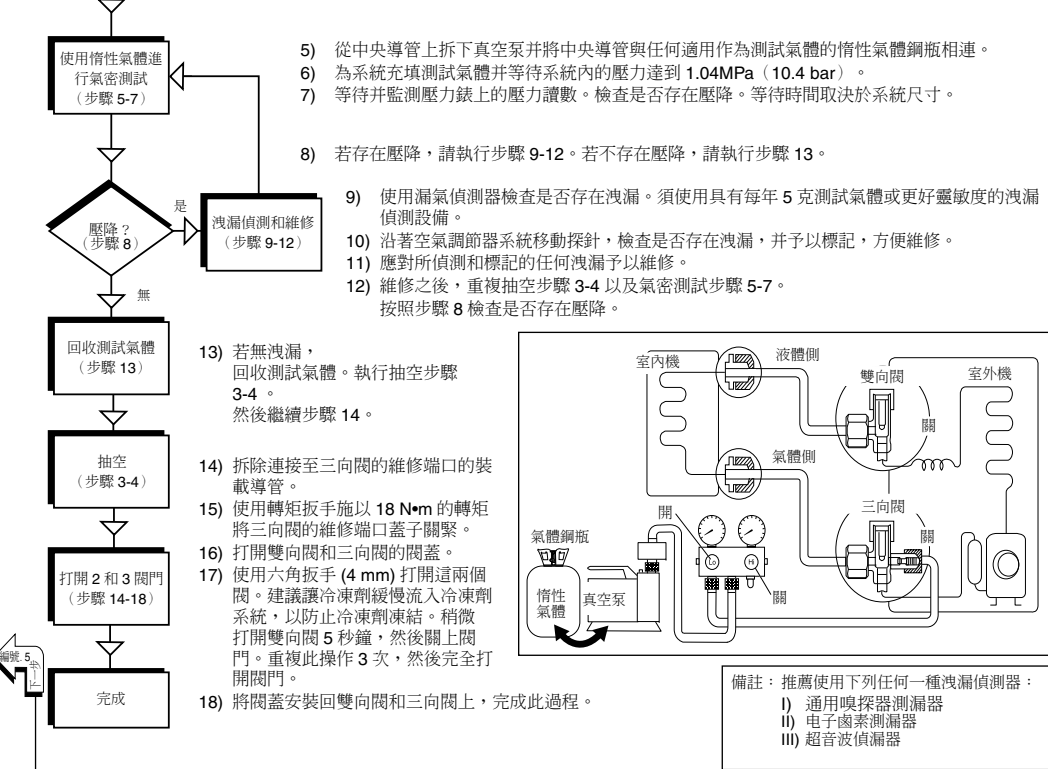

如何取出前格柵

- 若有必要，如進行安裝或檢修服務，請跟從以下步驟取出前格柵。
- 打開前面板。
- 如下圖所示，卸下前格柵上的3枚安裝螺絲。
- 將前格柵上方的3個鎖定裝置扭動至解鎖位置。
- 將前格柵朝自己方向拉出，以取出前格柵。

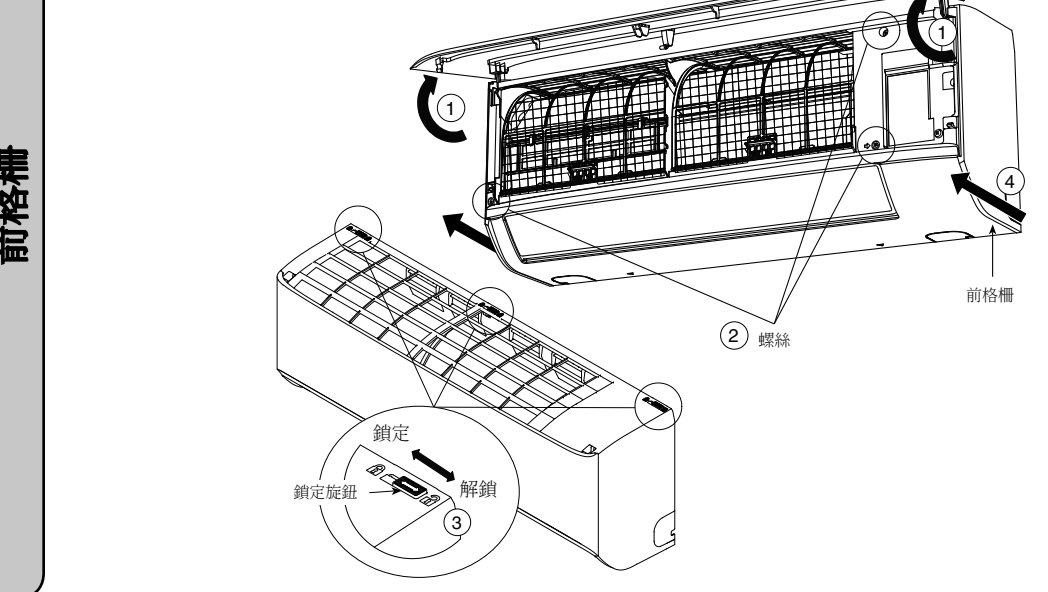

自動開關操作

- 自動操作模式
 - 一旦按下“自動開關”按鈕並在5秒之內鬆開，自動操作將立即生效。
- 試運轉操作(用於抽氣/檢修目的)
 - 如果持續按自動按鈕5至8秒鐘，試運轉操作將被激活。“嗚”聲在第5秒時將會響起，以顯示測試已開始操作。
- 遙控器接收聲的開關
 - 遙控器接收聲的開關可按下列步驟更改：
 - 持續按“AUTO”按鈕16至21秒鐘。在第十六秒鐘時會發出“嗚”、“嗚”、“嗚”、“嗚”聲音。
 - 按下“AC Reset”鍵一次，您將會聽到“嗚”聲，表示遙控器接收聲設定模式已被開啟。
 - 再按“AUTO”按鈕。每次(在60秒的間隔內)按“AUTO”鍵，遙控器的接收聲狀態將會在開和關之間轉換。較長的“嗚”聲表示遙控器的接收聲設定已被關閉。

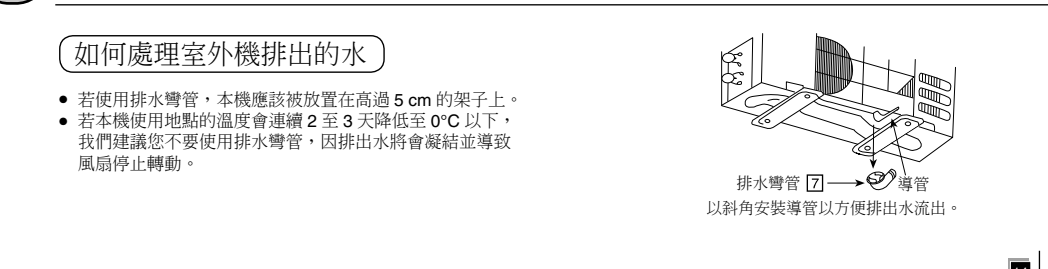

5 如下圖所示，移除膠帶及連接室內機和室外機之間的連接電纜。

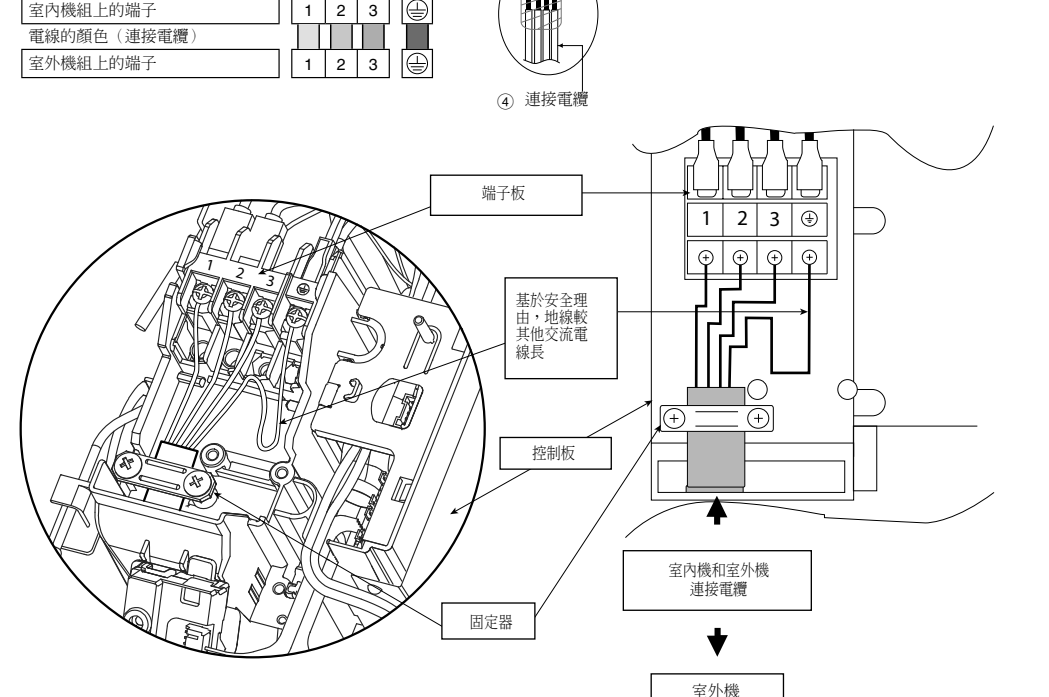

- 用固固件把連接電纜牢牢地固定在控制板上。請勿過度擰緊固定器固定螺絲，否則可能會損壞固定器。
- 關上格柵門，鎖緊螺絲然後關上前面板。

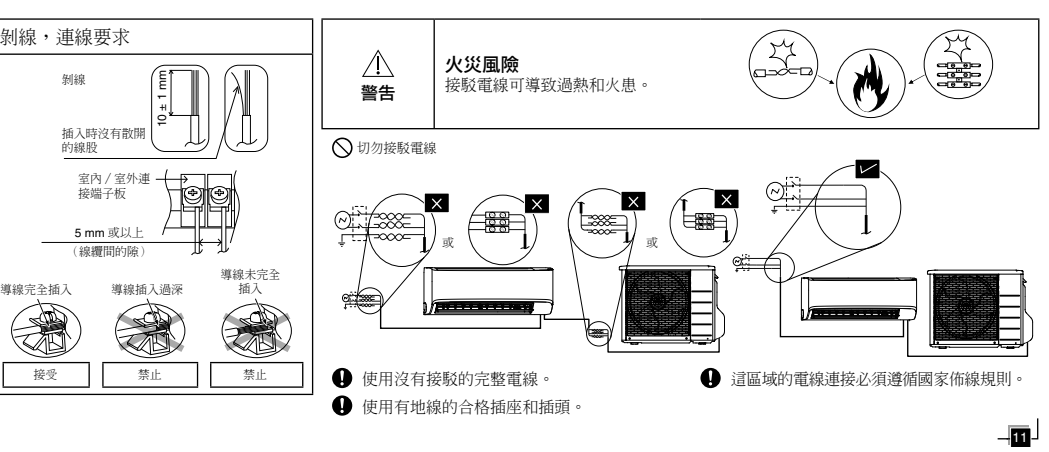

檢查排水

- 打開前面板，然後取下空氣過濾器。
- 排水檢查可在不卸下前格柵的情況下進行。
- 往排水托盤的液體倒水一杯水。
- 確保水從室內的排水管流出。

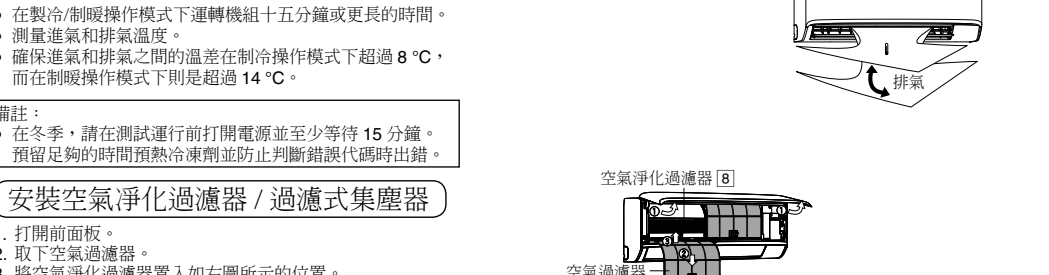

性能評估

- 在製冷/制暖操作模式下運轉機組十五分鐘或更長的時間。
- 測量進氣和排氣溫度。
- 確保進氣和排氣之間的溫差在制冷操作模式下超過8°C，而在制暖操作模式下是超過14°C。



安裝空氣淨化過濾器/過濾式集塵器

- 打開前面板。
- 取下空氣過濾器。
- 將空氣淨化過濾器置入如右圖所示的位置。

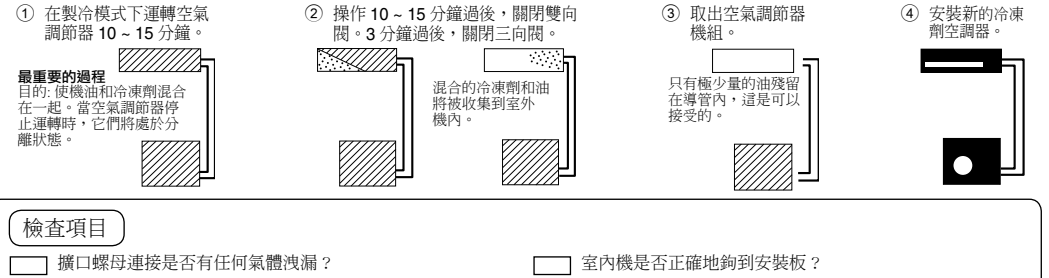

正確的抽氣方法

- 在製冷模式下運轉空氣調節器10-15分鐘。
- 操作10-15分鐘過後，關閉雙向閥3分鐘過後，關閉三向閥。
- 取出空氣調節器機組。
- 安裝新的冷凍劑空調節器。

