

Operating Instructions LED TV

English

Model No.

TH-24G400H

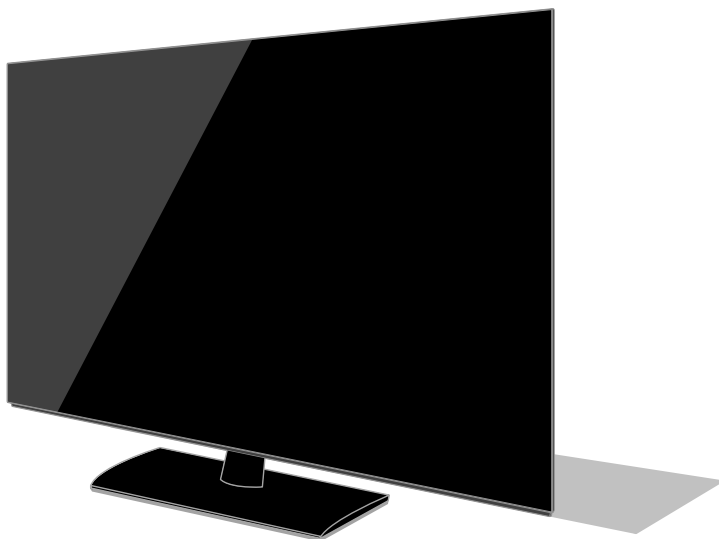

Thank you for purchasing this Panasonic product.

Please read these instructions carefully before operating this product and retain them for future reference.

Please carefully read the “Safety Precautions” of this manual before use.

The images shown in this manual are for illustrative purposes only.

EXA



TQB4GD0282



Manufactured under license from Dolby Laboratories. Dolby, Dolby Audio and the double-D symbol are trademarks of Dolby Laboratories.

The terms HDMI and HDMI High-Definition Multimedia Interface, and the HDMI Logo are trademarks or registered trademarks of HDMI Licensing Administrator, Inc. in the United States and other countries.



RealMedia, RealVideo and RealAudio are trademarks or registered trademarks of RealNetworks, Inc.

These statements are under the Licence Agreement with RealNetworks, Inc.

4.4.2.1 Terms of use must prohibit the user from modifying, translating, reverse engineering, decompiling, disassembling or using other means to discover the Source Code or otherwise replicate the functionality of the Client Code, except to the extent that this restriction is expressly prohibited by applicable law.

4.4.2.2 Terms of use must effectively disclaim on behalf of Real all warranties and conditions other than those set forth in this Agreement, express and implied, including implied warranties or conditions of merchantability and fitness for a particular purpose; and effectively exclude all liability for indirect, special, incidental and consequential damages, including but not limited to lost profits or replacement systems.

This product is licensed under the AVC patent portfolio license for the personal and non-commercial use of a consumer to (i) encode video in compliance with the AVC Standard ("AVC Video") and/or (ii) decode AVC Video that was encoded by a consumer engaged in a personal and non-commercial activity and/or was obtained from a video provider licensed to provide AVC Video. No license is granted or shall be implied for any other use.

Additional information may be obtained from MPEG LA, LLC.

See <http://www.mpegla.com>.

Panasonic does not guarantee operation and performance of peripheral devices made by other manufacturers; and we disclaim any liability or damage arising from operation and/or performance from usage of such other maker's peripheral devices.



This mark indicates the product operates on AC voltage.



This mark indicate a Class II or double insulated electrical appliance wherein the product does not require a safety connection to electrical earth (ground).

Notice for Digital terrestrial broadcasting functions

- Function related to Digital broadcasting will work in the areas where the digital terrestrial broadcasting services are received. Consult your local Panasonic Dealer with coverage areas.
- Not all the features are available depending on the country, area, broadcaster and service provider.
- This TV has the capability for Digital broadcasting specifications. But future Digital broadcasting services cannot be guaranteed.

Even if no special notation has been made of company or product trademarks, these trademarks have been fully respected.

Contents

Safety Precautions	3
Setting Up the TV	5
Connecting the TV	6
Initial Setup	8
Operating the TV	9
Using TV Guide	10
Watching External Inputs	11
Using Media Player	11
Using HEXABOOST	12
Using the Menu Functions	13
Additional Information	18
Troubleshooting	20
Maintenance	21
Specifications	22

Safety Precautions

To help avoid risk of electrical shock, fire, damage or injury, please follow the warnings and cautions below:

■ Mains plug and lead

Warning

If you detect anything unusual, immediately remove the mains plug.

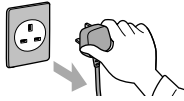

Note

● Mains Plug and lead types vary depending on the model and countries.

- This TV is designed to operate on AC ~ 220 - 240 V, 50 / 60 Hz.
- Insert the mains plug fully into the mains socket.
- To turn Off the apparatus completely, you must pull the mains plug out of the mains socket. Consequently, the mains plug should be easily accessible at all times.
- Disconnect the mains plug when cleaning the TV.
- Do not touch the mains plug with wet hands.



● Do not damage the mains lead.

• Do not place a heavy object on the lead.



• Do not place the lead near a high temperature object.



• Do not pull on the lead. Hold onto the mains plug body when disconnecting the plug.



- Do not move the TV with the lead plugged into a mains socket.
- Do not twist the lead, bend it excessively or stretch it.
- Do not use a damaged mains plug or mains socket.
- Ensure the TV does not crush the mains lead.

● Do not use any mains lead other than that provided with this TV.

■ Take care

Warning

● Do not remove covers and never modify the TV yourself as live parts are accessible and risk of electric shock when they are removed. There are no user serviceable parts inside.



● Do not expose the TV to rain or excessive moisture. This TV must not be exposed to dripping or splashing water and objects filled with liquid, such as vases, must not be placed on top of or above the TV.



- Do not insert foreign objects into the TV through the air vents.
- If the TV is used in an area where insects may easily enter the TV.
It is possible for insects to enter the TV, such as small flies, spiders, ants, etc. which may cause damage to the TV or become trapped in an area visible on the TV, e.g. within the screen.
- Do not use an unapproved pedestal / mounting equipment. Be sure to ask your local Panasonic dealer to perform the setup or installation of approved wall-hanging brackets.
- Do not apply strong force or impact to the display panel.
- Ensure that children do not climb on the TV.
- Do not place the TV on sloping or unstable surfaces, and ensure that the TV does not hang over the edge of the base.



Warning

Never place a TV in an unstable location. A TV may fall, causing serious personal injury or death. Many injuries, particularly to children, can be avoided by taking simple precautions such as:

- Using cabinets or stands recommended by the manufacturer of the TV.
- Only using furniture that can safely support the TV.
- Ensuring the TV is not overhanging the edge of the supporting furniture.
- Not placing the TV on tall furniture (for example, cupboards or bookcases) without anchoring both the furniture and the TV to a suitable support.
- Not placing the TV on cloth or other materials placed between the TV and supporting furniture.
- Educating children about the dangers of climbing on furniture to reach the TV or its controls.

- This TV is designed for table-top use.
- Do not expose the TV to direct sunlight and other sources of heat.



To prevent the spread of fire, keep candles or other open flames away from this product at all times



■ Suffocation / Choking Hazard

Warning

- The packaging of this product may cause suffocation, and some of the parts are small and may present a choking hazard to young children. Keep these parts out of reach of young children.

■ Display

Caution

- Do not spray water or detergent directly on TV screen for cleaning purpose. Leaking liquid substance will cause damage to TV.
- Be careful of cats, rats or other animals that may urinate on the TV (front and rear). It may lead to TV failure.
- Do not use sharp or hard objects (finger nails, knife and etc.) on TV screen. This may cause damage to the screen surface.

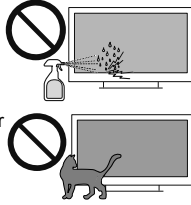

■ Pedestal

Warning

- Do not disassemble or modify the pedestal.

Caution

- Do not use any pedestal other than the one provided with this TV.
- Do not use the pedestal if it becomes warped or physically damaged. If this occurs, contact your nearest Panasonic dealer immediately.
- During setup, make sure that all screws are securely tightened.
- Ensure that the TV does not suffer any impact during installation of the pedestal.
- Ensure that children do not climb onto the pedestal.
- Install or remove the TV from the pedestal with at least two people.
- Install or remove the TV by the specified procedure.

■ Ventilation

Caution

Allow sufficient space (at least 10 cm) around the TV in order to help prevent excessive heat, which could lead to early failure of some electronic components.

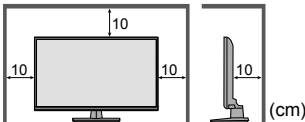

- Ventilation should not be impeded by covering the ventilation openings with items such as newspapers, tablecloths and curtains.
- Whether you are using a pedestal or not, always ensure the vents at the bottom of the TV are not blocked and there is sufficient space to enable adequate ventilation.



■ Moving the TV

Caution

- Before moving the TV, disconnect all cables.
- At least two people are required to move the TV.

■ When not in use for a long time

Caution

- This TV will still consume some power even in the Off mode, as long as the mains plug is still connected to a live mains socket.
- Remove the mains plug from the wall socket when the TV is not in use for a prolonged period of time.

■ Use conditions

Caution

- This appliance is intended for use in tropical climates.

■ Battery for the Remote Control

Caution

- Incorrect installation may cause battery leakage, corrosion and explosion.
- Replace only with the same or equivalent type.
- Do not mix old and new batteries.
- Do not mix different battery types (such as alkaline and manganese batteries).
- Do not use rechargeable batteries (Ni-Cd, etc.).
- Do not burn or break up batteries.
- Do not expose batteries to excessive heat such as sunshine, fire or the like.
- Make sure you dispose of batteries correctly.
- Remove the battery from the unit when not using for a prolonged period of time to prevent battery leakage, corrosion and explosion.

Setting Up the TV

Attaching the pedestal

Supplied accessories

Accessories may not be placed all together. Take care not to throw them away unintentionally.

Operating Instructions

Remote Control

- N2QAYB001116
- ➔ (p. 9)



Batteries (R6) × 2

- ➔ (p. 6)



Mains Lead

- ➔ (p. 7)

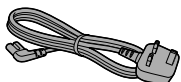

Pedestal

- ➔ (p. 5)

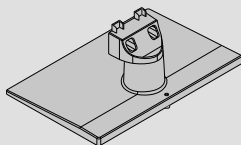

- Assembly screws

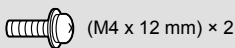

Note

- Illustrations shown may be different between models and countries.

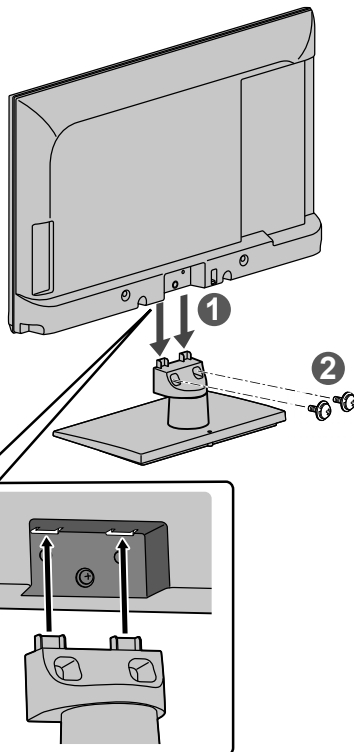

Removing the pedestal from the TV

Be sure to remove the pedestal in the following way when using the wall-hanging bracket or repacking the TV.

- 1 Remove the assembly screws from the TV.
- 2 Pull out the pedestal from the TV.

Inserting remote's batteries

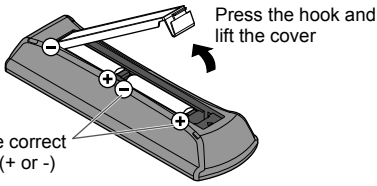

Wall mounting the TV (optional)

Please contact your local Panasonic dealer to purchase the recommended wall-hanging bracket.

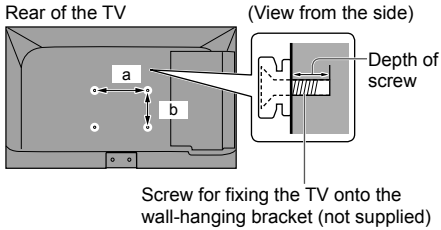

■ Holes for wall-hanging bracket installation

- a: 100 mm
b: 100 mm

■ Screw specification

- Type: M4
Depth of screw:
Minimum: 8 mm
Maximum: 12 mm

Warning

- Using other wall-hanging brackets, or installing a wall-hanging bracket by yourself have the risk of personal injury and product damage. In order to maintain the unit's performance and safety, be absolutely sure to ask your dealer or a licensed contractor to secure the wall-hanging brackets. Any damage caused by installing without a qualified installer will void your warranty.
- Carefully read the instructions accompanying optional accessories, and be absolutely sure to take steps to prevent the TV from falling off.
- Handle the TV carefully during installation since subjecting it to impact or other forces may cause product damage.
- Take care when fixing wall brackets to the wall. Always ensure that there are no electrical cables or pipes in the wall before hanging bracket.
- To prevent fall and injury, remove the TV from its fixed wall position when it is no longer in use.

Connecting the TV

- Please ensure the TV is disconnected from the mains socket / power point before attaching or disconnecting any RF / AV leads.
- External equipment and cables are for illustrative purposes only and not supplied with this TV.
- Check the type of terminals and cable plugs are correct when connecting.
- When using an HDMI cable, use the fully wired one.
- Keep the TV away from electronic equipment (video equipment, etc.) or equipment with an infrared sensor. Otherwise, distortion of image / sound may occur or operation of other equipment may be interfered.
- Also read the manual of the equipment being connected.

Terminals

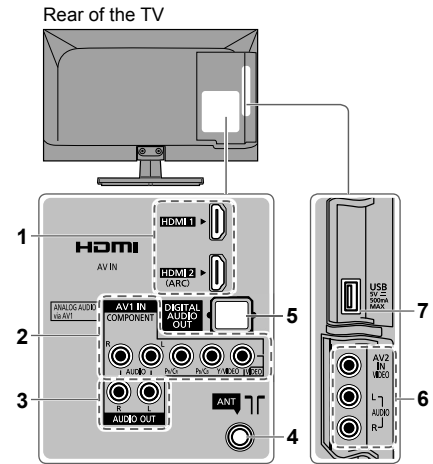

- HDMI 1 - 2
- AV1 IN
- AUDIO OUT
- Aerial terminal
- DIGITAL AUDIO OUT
- AV2 IN
- USB port

--- This symbol indicates DC operation.

Connections

Aerial and mains lead

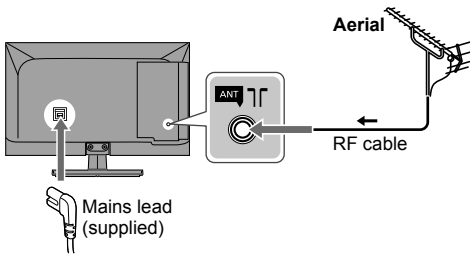

Insert the mains plug firmly into place.

- When disconnecting the mains lead, be absolutely sure to disconnect the mains plug at the mains socket first.

- Keep RF (aerial) cable away from the mains lead to avoid and minimise mains interference pickup.
- Do not place the RF cable under the TV.
- An aerial, correct cable (75 Ω coaxial) and correct terminating plug are required to obtain optimum quality picture and sound.
- If a communal aerial system is used, you may require the correct connection cable and plug between the wall aerial socket and the TV.
- Your local Television Service Centre or dealer may be able to assist you in obtaining the correct aerial system for your particular area and the accessories required.
- Any matters regarding aerial installation, upgrading of existing systems or accessories required, and the costs incurred, are the responsibility of you, the customer.
- If the aerial is placed in the wrong location, interference might happen.

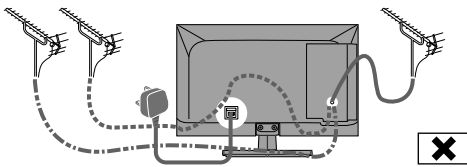
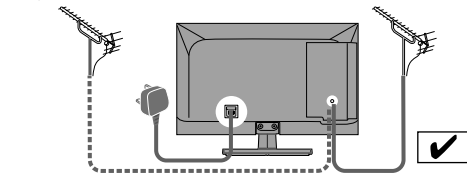

DVD Recorder / VCR

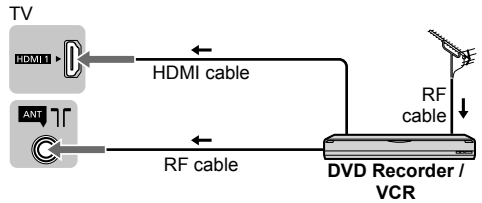

Set top box

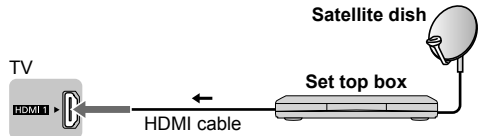

AV / Game equipment

■ Using HDMI terminal

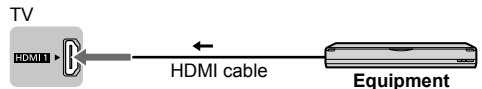

- You can also make similar connection via HDMI 2.

■ Using COMPONENT terminals

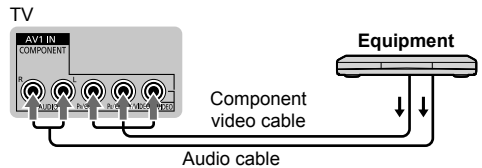

■ Using COMPOSITE terminals

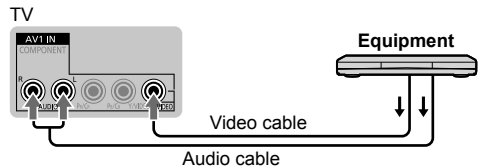

Speaker system

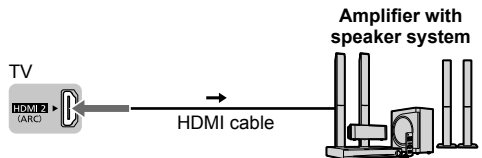

- Use HDMI 2 for connecting an amplifier that has ARC (Audio Return Channel) function. For an amplifier without ARC function, use DIGITAL AUDIO OUT.
- To enjoy the sound from the external equipment in multi-channel sound (e.g. Dolby Digital 5.1ch), connect the equipment to the amplifier. For the connections, read the manuals of the equipment and amplifier.

Initial Setup

When you first turn on the TV, a series of steps will pop-up to guide you to setup your TV.

- These steps are not necessary if the setup has been completed by your local dealer.

1 Plug the mains plug into the mains socket and turn on the TV.

It may take a few seconds before the screen is displayed.

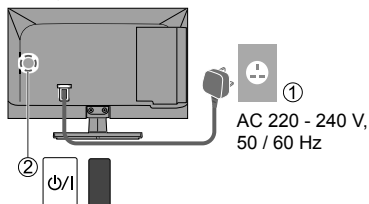

2 Select your language.

3 Select your area.

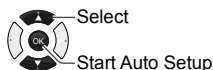

4 Scanning starts.

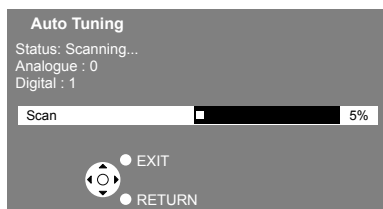

- This function searches and stores TV channels.
- The stored channels and sorted channel order vary depending on the area, broadcasting system and conditions of signal reception.

5 Select [Home].

Please select your viewing environment.

Home Shop



- [Shop] is for shop display.
- To change the viewing environment later on, you need to initialise all settings by accessing [Shipping Condition] (p. 16).

Setup is now complete and your TV is ready for viewing.

Note

- If tuning has failed, check the connection of the RF cable, then follow the on-screen instructions.

Operating the TV

Using the remote control

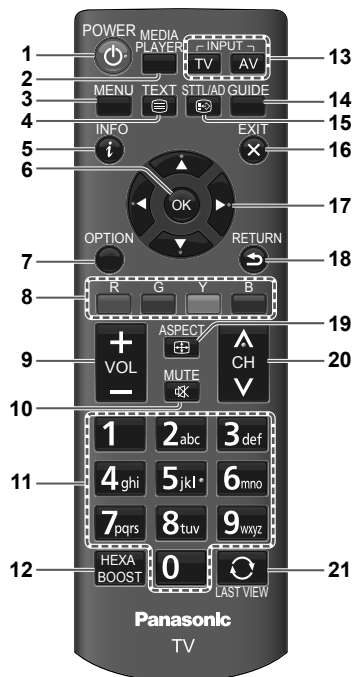

- 1 : Standby On / Off switch
- 2 **MEDIA PLAYER** ➔ (p. 11)
- 3 Displays **[Main Menu]** ➔ (p. 13)
- 4 **Textelet button**
 - This button is not used for this model.
- 5 Displays **Information banner**
- 6 **OK**
 - Confirms selections.
 - Press after selecting channel positions to quickly change channel.
 - Displays the **[Channel List]**.
- 7 Displays **[Option Menu]**
 - Shortcut to subtitle language / sound settings.
 - Follow the operation guide to select / change the settings.
- 8 **Coloured buttons**
 - Performs multiple operations which correspond to the operation guide displayed on the menu screen.
- 9 **Volume Up / Down**
- 10 **Sound Mute On / Off**
- 11 **Numeric buttons**
 - Changes channel.
 - Sets characters.
 - When in Standby mode, switches TV On.
- 12 **Activate HEXABOOST function**

13 Input mode selection

- TV - switches to TV input mode. (Digital TV or Analogue TV).
- AV - displays **[Input Selection]** screen (p. 11) or press repeatedly to select the input mode.

14 TV Guide ➔ (p. 10)

15 Displays subtitles

16 Exits to the TV viewing screen

17 Cursor buttons

- Makes selections or adjustments.

18 Returns to the previous menu / page

19 ASPECT

- Displays the **[Aspect Selection]** screen. Follow the operation guide to select the mode. **[16:9]** / **[14:9]** / **[Just]** / **[4:3]** / **[4:3 Full]** / **[Zoom1]** / **[Zoom2]** / **[Zoom3]** ➔ (p. 19)
- You can also press the button repeatedly to select the mode.

20 Channel Up / Down

21 Returns to the last viewed channel

[Channel List]

Lists out channels based on Analogue / Digital / All (Analogue + Digital)

- List of all analogue and digital channels
- List of digital channels only
- List of analogue channels only
- List of **[Favourites Edit]** ➔ (p. 16)

About operation guide

When operating the TV with the remote control, follow the operation guide available at the bottom of the screen to perform the operation you want.

Example: **[Aspect Selection]**

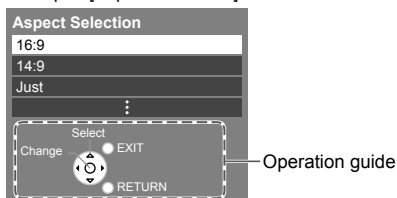

Referring to the operation guide:

- To select the mode
- To change to the selected mode
- To return to the previous menu
- To exit from the menu



Using the TV controls

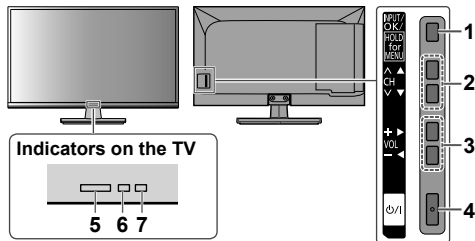

Note

- Location of indicators may vary depending on the models.

1 Changes the input mode

Displays [Main Menu] when press and hold for 3 seconds

- Press again and hold for 3 seconds to return to the previous screen from submenus / exit from main menu page.

2 Channel Up / Down

Cursor Up / Down

- Makes selections in the menu system.

3 Volume Up / Down

Cursor Left / Right

- Makes selections and / or adjustments when in the menu system.

4 Mains power On / Off switch

- Use to switch the mains power.
- To turn Off the apparatus completely, you must pull the mains plug out of the mains socket.
- [P]/[I]: Standby / On

5 Remote control signal receiver

6 C.A.T.S. (Contrast Automatic Tracking System) sensor

- Senses brightness to adjust picture quality when [Eco Mode] in the [Picture] menu is set to [On].
→ (p. 13)

7 Power LED

- Red: Standby
- Green: On
- The LED blinks when the TV receives a command from the remote control.

Using TV Guide

The TV Guide - Electronic Programme Guide (EPG), shows a list of broadcasts for several days (depending on the broadcasters).

- When this TV is turned on for the first time, or switched off for more than a week, it may take some time before the TV Guide is completely shown.
- This function varies depending on the country you select (p. 8).
- Digital and Analogue channels are displayed on the same TV Guide screen. There will be no programme listings for Analogue channels.
- TV mode only.

Display the TV Guide.

GUIDE



Example:



- 1 Current date and time
- 2 TV Guide date
- 3 TV Guide time
- 4 Programme
- 5 Channel position and name

Follow the operation guide to operate the TV Guide.

Note

- It may be slow to response when pressing the **UP/ DOWN** cursor button for TV program guide. This is due to program data downloading.
- **EXIT / RETURN** for selected channel.

[Type filter]

Let's you view a channel list of the selected type filter.

B

(Press again to return to TV Guide.)

(Type list)

Type	Subtype
MOVIE	Drama
NEWS	Detective
⋮	⋮

When you highlight on [Type], the corresponding [Subtype] will be shown. [Type] / [Subtype] are multi-selectable.



Select [Type]/[Subtype] screen



Select [Type]/[Subtype] item
Add/Remove

Watching External Inputs

- 1 Connect the external equipment.
→ (p. 7)
- 2 Display the [Input Selection] menu, then select the input of the connected equipment.

Example:

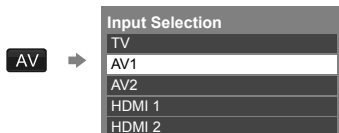

Note

- You can label or skip each input mode.
→ [Input Labels] (p. 15)
Skipped inputs will not be displayed when the AV button is pressed.
- If the external equipment has an aspect adjustment function, set it to "16:9".

Using Media Player

Media Player allows you to enjoy photo, music or video recorded on a USB Flash Memory.

- During the operation, audio signal is output from DIGITAL AUDIO OUT, AUDIO OUT or HDMI 2 (ARC function) terminals. To use HDMI 2 with ARC function, connect an amplifier that has ARC function and set to use theatre speakers (p. 7).
- The picture may not appear correctly on this TV depending on the digital cameras used.
- Display may take some time when there are many files and folders in the USB Flash Memory.
- Partly degraded files might be displayed at a reduced resolution.
- The folder and file names may be different depending on the digital camera used.

Inserting / Removing the USB Flash Memory

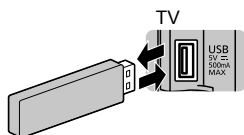

- Insert or remove straight and completely.

Starting Media Player

- 1 Insert the USB Flash Memory.
- 2 Start Media Player.



- 3 Select the mode.



[Photo]: Displays the thumbnail of all photos in the USB Flash Memory.

[Music]: Displays the thumbnail of music folders in the USB Flash Memory.

[Movie]: Displays the thumbnail of video titles in the USB Flash Memory.

[Contents Select]

Switching between modes

When you are in the thumbnail view of any mode, you can change to the other mode by accessing the [Contents Select] screen.



[Drive Select]

For USB with partition, you can change to the other partition directly in the same mode.



Follow the operation guide to perform available operations in each mode.

- INFO
- Displays the information of the highlighted content.
 - Displays / hides the operation guide.

Photo mode



Operation guide

[E] : Error display

[View]

Enters Single view mode to view photo one at a time.

[Slideshow]

Lets you view all photos in the slideshow mode.

[View Select]

Lets you toggle between all photos view and folder view.

G

[All photos]: Display all photos.

[Folder view]: Display the thumbnails grouped by folder.

[Option Menu]■ **[Slideshow Settings]**

- **[Transition Effect]:** Effect for photo switching during slideshow. [None] / [Dissolve] / [Wipe right] / [Wipe left] / [Wipe up] / [Wipe down] / [Box in] / [Box out] / [Random]
- **[Screen Mode]:** Screen mode for Single view and Slideshow. [Normal] / [Zoom]
 - In [Normal] screen mode, depending on the photo size, it may not be fully enlarged to fill the screen. E.g.: portrait style picture.
- **[Interval]:** Slideshow interval. [5 / 10 / 15 / 30 / 60 / 90 / 120 seconds]
- **[Repeat]:** Slideshow repeat. [Off] / [On]
- **[Back Ground Music]:** Background music during photo viewing. [Off] / [Type1] / [Type2] / [Type3]

Note

- Picture quality may become lower depending on the slideshow settings.

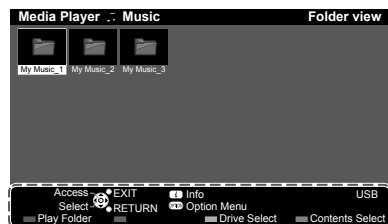
Music mode

Operation guide

[Play Folder]

Playbacks all music in the selected folder.

R

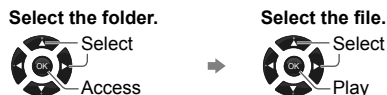
■ **To playback the selected file only****[Option Menu]**■ **[Music Setup]**

- **[Repeat]:**
 - [One]: Playback repeat on the selected one file.
 - [Folder]: Playback repeat within the selected folder.
 - [Off]: Playback repeat off.

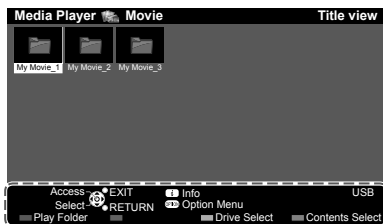
Movie mode

Operation guide

[Play Folder]

Playbacks all movies in the selected folder.

R

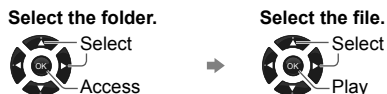
■ **To playback the selected file only****[Option Menu]**■ **[Video Setup Menu]**

- **[Multi Audio]:** Selects the sound tracks (if available) during video playback.
- **[Subtitle]:** Selects the subtitle (if available) during video playback.
- **[Aspect Change]:** Selects the aspect mode during video playback. [16:9] / [14:9] / [Just] / [4:3 Full] / [Zoom1] / [Zoom2] / [Zoom3]
 - [4:3 Full] only available for HD videos.
 - You can also change the aspect by pressing the **ASPECT** button repeatedly.
- **[Repeat]:** Playback repeat options. [Off] / [On]

Using HEXABOOST

1 Display the HEXABOOST modes.



2 Select the HEXABOOST modes.

Example:

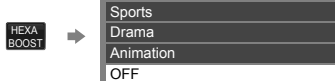
**Note**

- Default setting for HEXABOOST mode is OFF.
- Settings can be changed by pressing the HEXABOOST button.
- Cursor cannot be used for selections.
- In Media Player, HEXABOOST only valid in full screen Video.

[HEXABOOST modes]

- **[Sports]:** Expression of fresh lawn with clear image.
- **[Drama]:** Vivid yet natural skin tone.
- **[Animation]:** Clear and vivid animation picture.

- Access the submenu

Child Lock Access



Access

Note

- Only available items can be selected.

Using the Menu Functions

1 Display the menu.

MENU



Example:

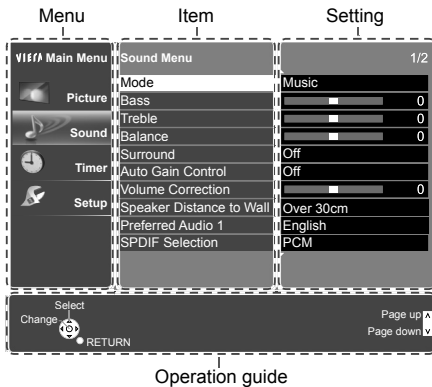

Operation guide

2 Select the menu.



Select

Access

3 Select the item.



Select

Change / Adjust / Access / Reset

4 Change the setting.

Example:

- Change the setting option

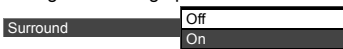

Select

Access

- Adjust the intensity bar



Adjust

Picture

[Viewing Mode]

Sets the picture mode for each input. **[Dynamic]** / **[Normal]** / **[Cinema]** / **[True Cinema]**

[Dynamic]: Improves contrast and sharpness for viewing in a bright room.

[Normal]: For viewing in a normal lighting condition.

[Cinema]: Improves the performance of contrast, black and colour reproduction for watching movies in a darkened room.

[True Cinema]: Reproduces the original image quality precisely without any revision.

In each [Viewing Mode], the settings for [Backlight], [Contrast], [Brightness], [Colour], [Sharpness], [Tint], [Colour Balance], [Eco Mode], [P-NR] and [3D-COMB] can be adjusted and stored for each input.

- Not available when [HEXABOOST] is enabled.

[Backlight], [Contrast], [Brightness], [Colour], [Sharpness]

Increases or decreases the levels of these options according to your personal preference.

[Tint]

Adjusts the picture hue to suit your taste.

- For NTSC signal reception.

[Colour Balance]

Selects the colour temperature of the picture.

[Cool] / **[Normal]** / **[Warm]**

- Not available when [Viewing Mode] is set to [True Cinema].

[Channel Colour Set]

Adjusts the suitable colour density from 3 levels for each channel.

- Select the channel to adjust and set this function.

[Eco Mode]

Automatically adjusts picture settings depending on ambient lighting conditions. **[Off]** / **[On]**

[P-NR]

Picture noise reduction function which reduces unwanted picture noise and flicker noise in the contoured parts of a picture. **[Off]** / **[Min]** / **[Mid]** / **[Max]**

[3D-COMB]

Makes still or slow moving pictures more vivid.

[Off] / **[On]**

- Set to [On] to improve the colours if patterning is seen while watching still or slow moving pictures.

- For PAL / NTSC signal reception in TV mode or from composite input.

[Colour Matrix]

Adjusts suitable colour parameters for [SD] (standard definition) or [HD] (high definition).

[SD]: Input signal is a normal TV system.

[HD]: Input signal is a high definition system.

- Available only with 480p or 576p input on video signals in a natural colour from digital equipment connected to COMPONENT or HDMI terminal.

[Colour System]

Selects optional colour system based on video signals in AV mode. **[Auto]** / **[PAL]** / **[SECAM]** / **[M.NTSC]** / **[NTSC]**

[16:9 Overscan]

Selects the screen area displaying the image for 16:9 aspect. **[Off]** / **[On]**

[On]: Enlarges the image to hide the edge of the image.

[Off]: Displays the image in the original size.

- Set to [On] if noise is generated on the edge of the screen.
- This function can be memorised separately for SD (Standard definition) and HD (High definition) signals.

[Reset to Defaults]

Resets the current picture settings to defaults.

Sound**[Mode]**

Sets your favourite sound mode. **[Music]** / **[Speech]** / **[User]**

- The selected mode affects all input signals.

[Music]*: Improves sound quality for watching music videos, etc.

[Speech]*: Improves sound quality for watching news, drama, etc.

* In [Music] and [Speech] modes, you can adjust the [Bass] and [Treble] settings, and those settings will be stored for each mode.

[User]: Adjusts the sounds manually by using the equaliser.

– When you select [User] mode, [Equaliser] is active instead of [Bass] and [Treble]. Select [Equaliser] and adjust the frequency ➔ (p. 14).

- Not available when [HEXABOOST] is enabled.

[Bass]

Adjusts level to enhance or minimise lower, deeper sound output.

[Treble]

Adjusts level to enhance or minimise sharper, higher sound output.

[Equaliser]

Adjusts the frequency level to suit your favourite sound quality.

- This function is available when [Mode] is set to [User].
- Select the frequency and change the frequency level by using the cursor buttons.
- To enhance the bass sound, raise the level of the lower frequency. To enhance the treble sound, raise the level of the higher frequency.

- To reset the levels of each frequency to the default settings, select [Reset to Defaults] by using the cursor button, and then press the **OK** button.

[Balance]

Adjusts volume level of right and left speakers.

[Surround]

Surround sound settings. **[Off]** / **[On]**

[Auto Gain Control]

Automatically regulates large sound level differences between channels and inputs. **[Off]** / **[On]**

[Volume Correction]

Adjusts the volume of individual channel or input mode.

[Speaker Distance to Wall]

Compensates for the low frequency sound due to the distance between the speakers and the wall.

[Over 30cm] / **[Up to 30cm]**

- If the distance between the TV and wall is over 30 cm, [Over 30cm] is recommended.
- If the distance between the TV and wall is within 30 cm, [Up to 30cm] is recommended.

[Preferred Audio 1]

Selects the preferred language for Digital TV multi audio (depending on the broadcaster).

[MPX]

Selects multiplex sound mode (if available).

[Stereo]: Use this normally.

[Mono]: When stereo signal cannot be received.

- [M1]** / **[M2]:** Available while mono signal is transmitted.
- For Analogue TV only.

[SPDIF Selection]

SPDIF: A standard audio file transfer format.

Selects the initial setting for digital audio output signal from DIGITAL AUDIO OUT and HDMI 2 (ARC function) terminals. **[Auto]** / **[PCM]**

[Auto]: Dolby Digital is output as Dolby Digital Bitstream. HE-AAC and MPEG are output as PCM.

[PCM]: Digital output signal is fixed to PCM.

- For Digital TV or video contents of Media Player.

[MPEG Optical Level]

Adjusts the audio level output from DIGITAL AUDIO OUT terminal as the initial setting.

[-12 / -10 / -8 / -6 / -4 / -2 / 0 dB]

- Normally, PCM sound is higher comparing with the other types of audio track.

[HDMI 1/2 Input(HDMI)]

Selects to fit the input signal (p. 19).

[Digital] / **[Analogue]**

[Digital]: When sound is carried via the HDMI cable connection.

[Analogue]: When sound is not carried via the HDMI-DVI adaptor cable connection.

- For HDMI input only.

[SPDIF Delay]

Adjusts the time delay for the sound output from DIGITAL AUDIO OUT or HDMI 2 (ARC function) terminals if the sound does not synchronise with the image. **[0]** / **[10]** / **[20 to 200] (msec)**

[Downmix Mode]

Selects the output mode for listening to compressed music. **[Surround]** / **[Stereo]** / **[Dual1]** / **[Dual2]**

- Not available in Analogue TV mode.

[Type]

Narration settings for impaired users (only available in some countries). **[Normal]** / **[Hearing Impaired]** / **[Visually Impaired]**

[Hearing Impaired]: Provides aids in understanding and enjoyment with Digital TV subtitles (depending on the broadcaster).

[Visually Impaired]*: Activates the narration sound track when available on the broadcast.

- For Digital TV only.

* [Visually Impaired] (below) is available after you have selected this option.

[Visually Impaired]

■ [Speaker]

Narration sound track is output to the TV speakers.

[Off] / **[On]**

■ [Volume]

Adjusts the volume of the narration sound track.

■ [Pan and Fade]

Selects the audio pan and fade effect. **[Off]** / **[On]**

[Off]: Main Audio program.

[On]: Controls the level of the Main Audio Program and the pan of the Associated Audio Program.

[Reset to Defaults]

Resets the current sound settings to defaults.

Timer

[Off Timer]

Sets the duration until the TV automatically goes to Standby mode.

[Off] / **[15 / 30 / 45 / 60 / 75 / 90 minutes]**

[Auto Standby]

Enables the TV to turn into Standby mode automatically if no operation is performed after the selected period.

[Off] / **[2 hours]** / **[4 hours]**

- Automatic input switching with the connected equipment affects this function and time-count will be reset.

Setup

[Link Settings]

■ [CEC]

When set to [On], the TV will automatically switch to the appropriate HDMI input whenever an HDMI connected equipment is initially turned on and play mode is selected. **[Off]** / **[On]**

■ [Power off Link]

When set to [On], all HDMI connected equipment will be turned off automatically by turning off the TV.

[Off] / **[On]**

– A Panasonic DVD Recorder will not turn off if it is still in the Rec mode.

– The TV remains on even if all the HDMI connected equipment are turned off.

[Child Lock] ➔ (p. 17)

[Tuning Menu] ➔ (p. 16 - 17)

[Language]

■ [Language]

Changes language for on-screen displays.

[Display Settings]

■ [Preferred Subtitles 1]

Selects the preferred subtitle language for digital channels (depending on the broadcaster).

■ [Preferred Subtitle Type]

Selects the preferred subtitle type for digital channels (depending on the broadcaster). **[Normal]** / **[Hearing Impaired]**

■ [Input Labels]

Accesses the input labels list to select the label of each input mode or set to skip unconnected one for easier identification and selection in [Input Selection] (p. 11) or banner.

- To skip the input mode, select [Skip].

■ [Banner Display Timeout]

Sets how long the Information banner stays on screen (p. 18). **[0 (No display)]** / **[1 second]** / **[2 - 10 (seconds)]**

■ [Radio Mode]

Sets the timer to turn off the screen automatically when a radio channel is selected.

[Off] / **[5 / 10 / 15 / 20 seconds]**

– The sound is active even when the screen is off.

– This function could reduce power consumption when listening to a radio channel.

– Press any button except Standby, Volume Up / Down and Sound Mute buttons to turn on the screen.

– Not available in Analogue TV mode.

[System Menu]**■ [Shipping Condition]**

Resets all settings, including tuning data, to the original condition.

- Access this function and follow the on-screen instructions to complete the procedures.
- Initial Setup (p. 8) will automatically start after [Shipping Condition] completes.

■ [System Update] ➔ (p. 18)**■ [Software Licence]**

Displays the software licence information.

■ [System Information]

Displays the software version.

[Power Save]

Reduces brightness of picture to economise on power consumption. **[Off]** / **[On]**

Using the [Tuning Menu]

Use the [Tuning Menu] to retune the TV automatically or manually, add new channels, check signal conditions, create your favourite channel lists, skip unwanted channels, etc.

[Auto Tuning] (TV mode only)

Retunes the channels received in your area automatically.

- Automatically searches and adds available channels to the memory.
- After the scan is complete, all previously saved channels will be erased.



- When the operation is completed, the channel at the lowest position will be displayed.
- If tuning has not been done completely, perform [Analogue Manual Tuning].

[Scan]

Adds new channels automatically to the channel list. Example: Antenna

**[Analogue Manual Tuning]**

Sets analogue channel manually.

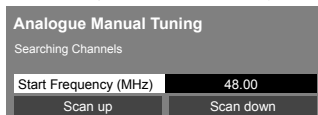
**1 Enter the frequency to start scanning.****2 Select the scanning method.**

- **[Scan up]:** Scans ascendingly from the entered frequency to higher frequencies.
- **[Scan down]:** Scans descendingly from the entered frequency to lower frequencies.

[DTMB Signal Condition]

Shows the Digital TV signal condition. Example:

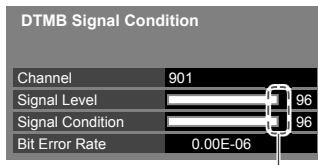

These bars show the maximum signal value of the selected channel.

[DTMB Manual Tuning]

Searches for the Digital TV channels manually. All channels found will be added to the Channel List.

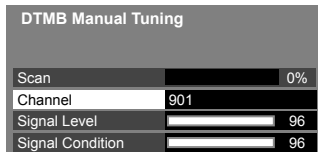
Select a channel position, then start tuning.**[Favourites Edit]**

Creates favourite channel lists from various broadcasters.

Select a channel to add or remove from the list.

(-o) : Encrypted channel



⬇ : Add
● : Remove

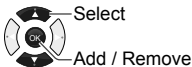

[Skip]

Skip or hides unwanted channels.

Select a channel, then reveal / hide.

Skip

4	Analogue	●
40	Analogue	○
901	Digital	○
902	Digital	○

○ : Hide (skip)
● : Reveal



[Sort]

Sorts channels.

1 Select a channel.

Sort

4	Analogue	●
40	Analogue	○
901	Digital	○
902	Digital	○

○ : Selected ● : Unselected



2 Swap the channel position (if available).



[Channel List Edit]

Edits channel settings.

1 Select a channel.

Channel List Edit

4	Analogue
40	Analogue
901	Digital
902	Digital



2 Edit the channel settings.

Channel List Edit

Network Name	
Channel	40
Channel Name	
Frequency (MHz)	48.25
Colour System	Auto
Sound System	B/G

- You cannot change the [Network Name].
- [Frequency], [Colour System] and [Sound System] edit are available for Analogue channels only.

Select an item.



Enter the new settings.

1	2	3
4	5	6
7	8	9
0		

or

Change the settings.



- You can set the characters by using the numeric and cursor buttons as follows:

0	_ 0	5	J K L 5
1	. ! : # 1	6	M N O 6
2	A B C 2	7	P Q R S 7
3	D E F 3	8	T U V 8
4	G H I 4	9	W X Y Z 9

Backspace

[Clear block]

Clears the entire channel list.

Select [OK] to clear.

Are you sure?

OK Cancel

Setting [Child Lock]

You can lock specific channels / AV input terminals. When the locked channel / input is selected, a message appears. Enter the PIN number to watch.

Enter the PIN number (4 digits).

Child Lock-PIN Entry

Please enter new PIN

PIN * * * *

- Enter the PIN number twice at first setting.
- Make a note of the PIN number in case you forget it.

Child Lock

Change PIN

Child Lock List Access

■ To lock channels or inputs

- 1 Select [Child Lock List].
- 2 Select a channel / input, then lock it.

Child Lock List - TV and AV

Name	Input	Type	Lock
7 BBC1 Wales	TV	TV	●
14 BBC THREE	TV	TV	●
101 E4C	TV	TV	●
...			

Select

Lock *EXIT

RETURN Lock all Unlock all

Page up Page down

G Y

☒ : Lock all, ☐ : Unlock all
☒ : Locked input / channel

■ To change the PIN number

- 1 Select [Change PIN].
- 2 Enter a new PIN number twice.

Note

- Setting [Shipping Condition] (p. 16) erases the PIN number and all settings.

Performing [System Update]

To update automatically

Set [Auto Download] and [Auto Install] to [Yes].

Setup	
Manual OAD Download	
Auto Download	Yes
Auto Install	Yes

- Once you have set the option, the TV automatically performs a search and download any available update.
- The automatic update can also perform when the TV is in Standby.

If [System Update] is performed, the software will be updated (it may change TV functions). If you do not want to do so, set [Auto Install] to [No].

To update immediately

1 Select [Manual OAD Download].

Setup	
Manual OAD Download	Access
Auto Download	No
Auto Install	No

The TV searches for an update (several minutes) and displays a corresponding message, if any.

2 Download the update.

Note

- Download may take more than 10 minutes.
- During software download and update, DO NOT switch off the TV.
- The notification message might be a reminder. In this case, the schedule information (the date that the new version can be used) will appear. You can set the reservation for update.

Additional Information

Auto power standby function

The TV will automatically go into Standby mode in the following conditions:

- No signal is received and no operation is performed for 30 minutes in Analogue TV mode.
- [Off Timer] is active in the [Timer] menu (p. 15).
- No operation is performed for the period selected in [Auto Standby] (p. 15).

Information banner

Example : Digital TV

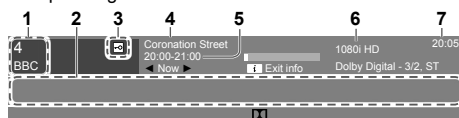

- 1 Channel position and name
- 2 Programme details
- 3 Channel type ([Radio], [Data], etc.) / Encrypted channel () / TV mode (D, TA)
- 4 Programme
- 5 Programme Start / Finish time (Digital TV) / Channel number, etc. (Analogue TV)
- 6 Input signal
- 7 Current time

Icon / Message	Meaning
⊗	Sound mute On
[Encrypted]	Scrambled programme
[Dolby Digital]	Dolby Digital audio track
[STTL]	Subtitle service available
[TTX]	Teletext service available
[ST], [Dual], [Mono]	Audio mode
1 - 90	Off Timer remaining time

■ To display extra information (Digital TV)

INFO



(Press again to hide the banner.)

Aspect

- **[16:9]**
Directly displays the image at 16:9 without distortion (anamorphic).
 - For Digital Broadcast channels, image will be displayed based on broadcasted channel aspect ratio.
- **[14:9]**
Displays the image at the standard 14:9 without distortion.
- **[Just]**
Displays a 4:3 image full-screen. Stretching is only noticeable at the left and right edges.
- **[4:3]**
Displays the image at the standard 4:3 without distortion.
- **[4:3 Full]**
Displays a 4:3 image enlarged horizontally to fit the screen.
 - For HD (High definition) signals only
- **[Zoom1]**
Displays a 16:9 letterbox or 4:3 image without distortion.
- **[Zoom2]**
Displays a 16:9 letterbox (anamorphic) image full-screen without distortion.
- **[Zoom3]**
Displays a 2.35:1 letterbox (anamorphic) image full-screen without distortion. At 16:9, displays the image at its maximum (with slight enlargement).

Input signal that can be displayed

Signal name	COMPONENT	HDMI
525 (480) / 60i, 60p	○	○
625 (576) / 50i, 50p	○	○
750 (720) / 60p, 50p	○	○
1,125 (1,080) / 60i, 50i	○	○
1,125 (1,080) / 60p, 50p, 24p		○

- Mark : Applicable input signal
- Signals other than above may not be displayed properly.
- The above signals are reformatted for optimal viewing on your display.

Supported file format in Media Player

- **Photo**
JPEG (.jpg, .jpeg)
 - Supported resolution: 8 × 8 to 30,719 × 17,279
 - DCF and EXIF standards
 - Sub-sampling: 4:4:4, 4:2:2, 4:2:0
 - **Music**
MP3 (.mp3) / AAC (.m4a)*1 / WMA (.wma)*1, 2 / LPCM (.wav) / FLAC (.flac)
 - **Video**
AVI (.avi)*2, 3 / MKV (.mkv)*3 / ASF (.asf, .wmv)*1, 2 / MP4 (.f4v, .m4v, .mp4)*4 / FLV (.flv) / 3GPP (.3gp, .3g2) / TS (.mts, .m2ts, .tp, .trp, .ts, .tts) / PS (.mod, .mpg, .mpeg, .vob, .vro) / RMVB (.rmvb, .rm)
- *1 Copy-protected files cannot be played back.
*2 WMA Pro and WMA Lossless are not supported.
*3 Some subtitles or chapter functions may not be available.
*4 This TV supports this container recorded with Panasonic products. For details, read the manual of the products.
- **Subtitles**
MicroDVD, SubRip, TMLPlayer (.srt, .sub, .txt)
 - The video file and subtitles text file are inside the same folder, and the file names are the same except for the file extensions.
 - If there are more than one subtitles text file inside the same folder, they are displayed in the following order of priority: ".srt", ".sub", ".txt".

Note

- Even if these conditions are fulfilled, some files may not play depending on how they are encoded.
- Do not use two-byte characters or other special codes for data.
- Connected devices may become unusable with this TV if the file or folder names are changed.

HDMI connection

This TV incorporates HDMI™ technology. HDMI (high-definition multimedia interface) is the world's first complete digital consumer AV interface complying with a non-compression standard. HDMI allows you to enjoy high-definition digital images and high-quality sound by connecting the TV and the equipment.

Applicable HDMI features

- Input audio signal:
2ch Linear PCM (sampling frequencies - 48 kHz, 44.1 kHz, 32 kHz)
- Input video signal:
 - ➔ **"Input signal that can be displayed" (p. 19)**
Match the output setting of the digital equipment.
- Audio Return Channel* (HDMI 2 terminal only)

■ DVI connection

If the external equipment has only a DVI output, connect to the HDMI terminal via a DVI to HDMI adaptor cable. When the DVI to HDMI adaptor cable is used, connect the audio cable to the audio input terminal (use AV1 IN AUDIO terminals).

Note

- Audio settings can be made on [HDMI 1/2 Input(HDMI)] in the [Sound] menu.
- These HDMI connectors are "type A".
- These HDMI connectors are compatible with HDCP (High-Bandwidth Digital Content Protection) copyright protection.
- Equipment having no digital output terminal may be connected to the input terminal of component or video to receive analogue signals.

* Audio Return Channel (ARC) is a function to send digital sound signals via an HDMI cable.

USB Flash Memory

For playing back in Media Player

Format: FAT16, FAT32

Compliance:

Supports only USB1.1 or USB2.0 standard.

Maximum USB capacity supported is 16GB.

USB Hub or card adapter is not supported.

Note

- Data modified with a PC may not be displayed.
- Do not remove the device while the TV is accessing data. Otherwise this can damage the device or TV.
- Do not touch the pins on the device.
- Insert the device in the correct direction. Otherwise this can damage device or TV.
- Electrical interference, static electricity, or erroneous operation may damage the data or device. Panasonic is not liable for any deterioration or damage of data or device during operations with the TV.
- It is recommended to connect the USB Flash Memory directly to the TV's USB port.
- Some USB devices or USB HUB may not be used with this TV.
- You cannot connect any devices by using USB card reader.

Troubleshooting

Before requesting service or assistance, please follow these simple guides to resolve the problem.

If an error message appears, follow the message's instructions.

If the problem still persists, please contact your local Panasonic dealer for assistance.

Screen

Red, blue, green or black spots on the screen.

→ This is the characteristic of liquid crystal panels. The liquid crystal panel is built with very high precision technology. Occasionally, a few non-active pixels may appear on the screen as points of red, green, blue or black. This does not affect the performance of your TV and it is not a quality problem.

Chaotic image, noisy.

- Set [P-NR] in the [Picture] menu to remove noise (p. 13).
- Check nearby electrical products (car, motorcycle, fluorescent lamp).

No image is displayed.

- Check the settings of [Contrast], [Brightness] or [Colour] in the [Picture] menu (p. 13).
- Check the TV is in AV mode. If the TV is in AV mode, check the selected input mode match the output of the external equipment (p. 11).

Blurry or distorted image.

- (No sound or low volume.)
- Reset channels. ➔ (p. 16)

Unusual image is displayed.

- Turn the TV off with Mains power On / Off switch (p. 10), then turn it on again. If the problem persists, initialise all settings. ➔ [Shipping Condition] (p. 16)

Pictures from equipment connected via HDMI are unusual.

- Check the HDMI cable is connected properly.
- Turn the TV and equipment off, then turn them on again.
- Check an input signal from the equipment (p. 19).
- Use equipment compliant with EIA/CEA-861/861D.

Sound

No sound is produced.

- Check the sound mute setting (p. 9) and volume.

Low level or distorted sound.

- Sound signal reception may be deteriorated.

Sound output via HDMI connection is unusual.

- Set the sound setting of the connected equipment to "2ch L.PCM".
- Check the [HDMI 1/2 Input(HDMI)] setting in the [Sound] menu (p. 14).
- If digital sound connection has a problem, select analogue sound connection (p. 20).

General

The TV goes into Standby mode.

→ This TV is equipped with auto power standby function (p. 18).

The remote control does not work or is intermittent.

- Replace the batteries (p. 6).
- Point the remote control directly at the remote control signal receiver of the TV (within about 7 m and 30 degree angle).
- Situate the TV away from sunshine or block sources of bright light from shining on the remote control signal receiver of the TV.

Parts of the TV become hot.

→ Even if the temperature of parts of the front, top and rear panels has risen, these temperature rises do not cause any problems in terms of performance or quality.

The TV panel moves slightly when it is pushed with a finger.

Clattered sound might be heard.

→ There is some flexibility around the panel to prevent damage. This is not a malfunction.

Overcurrent error message appears.

- The connected USB device might cause this error. Remove the device and turn the TV off with Mains power On / Off switch, then turn it on again.
- Check foreign objects are not inside the USB port.

Maintenance

First, remove the mains plug from the socket outlet.

Regular care

- Gently wipe the surface of the display panel, cabinet and pedestal by using a soft cloth.
- Wipe the mains plug with a dry cloth at regular intervals. Moisture and dust may lead to fire or electrical shock.

For stubborn dirt

First clean the dust on the surface. Dampen a soft cloth with clean water or diluted neutral detergent (1 part detergent to 100 parts water). Wring the cloth and wipe the surface. Finally, wipe away all the moisture.

Caution

- Do not use a hard cloth or rub the surface too hard as this could scratch the surface.
- Do not subject the TV's surfaces to water or detergent. Liquid inside the TV could lead to product failure.
- Do not subject the surfaces to insect repellent, solvent, thinner or other volatile substances. This may degrade surface quality or cause peeling of the paint.
- The surface of the display panel is specially treated and may be easily damaged. Take care not to tap or scratch the surface with your fingernail or other hard objects.
- Do not allow the cabinet and pedestal to make contact with a rubber or PVC substance for a long time. This may degrade surface quality.

Specifications

Model no.

TH-24G400H

Power source

AC 220 - 240 V, 50 / 60 Hz

Power consumption

(Rated power / Standby power)

33 W / 0.30 W

Display panel

Panel

LED backlight Liquid Crystal Display

Visible screen size (diagonal)

60 cm

Display resolution

1 366 (W) × 768 (H)

Dimensions (W × H × D)

562 mm × 409 mm × 180 mm (With Pedestal)

562 mm × 344 mm × 62 mm (TV only)

Mass

5.0 kg (With Pedestal)

4.5 kg (TV only)

Connection terminals

AV1 IN (COMPONENT / VIDEO)

VIDEO

Pin jack × 1, 1.0 V[p-p] (75 Ω)

AUDIO L - R

Pin jack × 2, 0.5 V[rms]

Y

1.0 V[p-p] (including synchronisation)

P_B/C_B, P_R/C_R

±0.35 V[p-p]

AV2 IN

VIDEO

Pin jack × 1, 1.0 V[p-p] (75 Ω)

AUDIO L - R

Pin jack × 2, 0.5 V[rms]

HDMI 1 / 2 input

TYPE A Connectors

USB

USB 2.0 TYPE A Connectors

DC = 5 V, Max. 500 mA

DIGITAL AUDIO OUT

PCM / Dolby Digital, Fibre optic

AUDIO OUT

AUDIO L - R

Pin jack × 2, 0.5 V[rms]

Sound

Audio output

6 W (3 W + 3 W)

Receiving systems / Band name

17 Systems	Function
1 PAL B, G, H	Reception of broadcast transmissions and Playback from Video Cassette Tape Recorders
2 PAL I	
3 PAL D, K	
4 SECAM B, G	
5 SECAM D, K	
6 SECAM K1	
7 NTSC M (NTSC 3.58/4.5 MHz)	
8 NTSC 4.43/5.5 MHz	Playback from Special VCR's or DVD
9 NTSC 4.43/6.0 MHz	
10 NTSC 4.43/6.5 MHz	
11 NTSC 3.58/5.5 MHz	
12 NTSC 3.58/6.0 MHz	
13 NTSC 3.58/6.5 MHz	
14 SECAM I	
15 PAL 60 Hz/5.5 MHz	Playback from Special Disc Players and Special VCR's or DVD
16 PAL 60 Hz/6.0 MHz	
17 PAL 60 Hz/6.5 MHz	

GB20600-2006 Mode-C=3780 8 MHz UHF (Hong Kong) free-to-air TV Broadcast reception

Receiving channels (Analogue TV)

VHF BAND

- 2-12 (PAL/SECAM B, K1)
- 0-12 (PAL B AUST.)
- 1-9 (PAL B N.Z.)
- 1-12 (PAL/SECAM D)
- 1-12 (NTSC M Japan)
- 2-13 (NTSC M USA)

UHF BAND

- 21-69 (PAL G, H, I/SECAM G, K, K1)
- 28-69 (PAL B AUST.)
- 13-57 (PAL D, K)
- 13-62 (NTSC M Japan)
- 14-69 (NTSC M USA)

CATV

- S1-S20 (OSCAR)
- 1-125 (USA CATV)
- C13-C49 (JAPAN)
- S21-S41 (HYPER)
- Z1-Z37 (CHINA)
- 5A, 9A (AUST.)

Aerial input

VHF / UHF

Operating conditions

Temperature

0 °C - 40 °C

Humidity

20 % - 80 % RH (non-condensing)

Note

- Design and Specifications are subject to change without notice. Mass and Dimensions shown are approximate.
- TH-24G400H comply with China Terrestrial Television National Standard (GB20600-2006) Mode-C=3780

This product incorporates the following software:

- (1) the software licensed under the GNU General Public License, Version 2.0 (GPL V2.0) and/or,
- (2) open sourced software other than the software licensed under the GPL.

The software categorized as (1) - (2) are distributed in the hope that it will be useful, but WITHOUT ANY WARRANTY, without even the implied warranty of MERCHANTABILITY or FITNESS FOR A PARTICULAR PURPOSE. Please refer to the detailed terms and conditions thereof shown in the "Software License" menu on this product.

At least three (3) years from delivery of this product, Panasonic Corporation will give to any third party who contacts us at the contact information provided below, for a charge no more than our cost of physically performing source code distribution, a complete machine-readable copy of the corresponding source code covered under GPL V2.0 or the other licenses with the obligation to do so, as well as the respective copyright notice thereof.

Contact Information: cdrequest@unipf.jp

The source code and the copyright notice are also available for free in our website below.

<http://www.unipf.jp/dl/DTV13ET/>

Information on Disposal in other Countries outside the European Union



This symbol is only valid in the European Union. If you wish to discard this product, please contact your local authorities or dealer and ask for the correct method of disposal.

Customer's Record

The model number and serial number of this product may be found on its rear panel. You should note this serial number in the space provided below and retain this book, plus your purchase receipt, as a permanent record of your purchase to aid in identification in the event of theft or loss, and for Warranty Service purposes.

Model Number _____

Serial Number _____

Panasonic Corporation

Web Site: <http://www.panasonic.com>