

Panasonic®

Operating Instructions
使用說明書
Petunjuk Pengoperasian

Double Heater Microwave Oven
烤焗微波爐
Tungku Gelombang Mikro dengan Pemanggang Ganda

Household Use Only
僅家庭用
Hanya Untuk Penggunaan Rumah Tangga

Model No.
型號: **NN-DF38PB**



Panasonic Kitchen Appliances Technology (Jiaxing) Co., Ltd.
No.369 Chenggong Road, Economic and Technological Development Zone,
Jiaxing, Zhejiang Province, China
Web Site: <http://www.panasonic.com>

F0003CX60HP
PA0424-0
Printed in China

Important safety instructions
Read carefully and keep for future reference
重要安全措施
仔細閱讀並妥善保存
Sebelum menggunakan Oven ini,
silahkan baca buku petunjuk pengoperasian secara menyeluruh

Table of Contents



























Quick Guide to Operation	2-3
IMPORTANT SAFETY INSTRUCTIONS	4-6
Installation and General Instructions	6-8
Microwaves and How They Work	8-9
Feature Diagram.....	10
Control Panel.....	11
Up/Down Selection	12
Display Window	12
Cooking Modes.....	13
Cookware and Utensil Chart.....	14
Beep Choice	15
Child Safety Lock Setting	15
Oven Lamp	15
Micro Power Setting	16
Micro Power Defrost Setting.....	17
Turbo Defrost Setting	17
Defrosting Tips and Techniques	18
Grill Setting	19-20
Oven Setting	21-22
Timer Setting (Kitchen Timer/Standing Time/Delay Start)	23
3-Stage Setting.....	24
Add Time Setting	25
Sensor Reheat Setting	26
Cleaning Setting	27
Auto Cook Setting and Menus.....	28-33
Defrosting Chart.....	34
Reheating Charts.....	35
Cooking Charts.....	36
Before Requesting Service.....	37-38
Care of your Microwave Oven.....	39
Technical Specifications	40

English

Quick Guide to Operation

After plugging in, "8888" will appear in the display window, then you can start to operate.























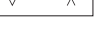



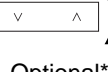

English

Feature	How to Operate	
To Set Beep Choice On/Off (page 15)	 →  →  Press once. Set the mode Press once. Default mode is "On"	
To Set/Cancel Child Safety Lock (page 15)	To Set:  →  Press 3 times	Cancel:  →  Press 3 times
To Turn Oven Lamp On/Off (page 15)	 Press	
To Use Microwave Power (page 16)	 →  →  Press once. Select the power level Press once.	
	 →  Set the cooking time Press once.	
To Use Microwave Defrost (page 17)	 →  →  Press once. Select 270 W Press once.	
	 →  Set the cooking time Press once.	
To Use Turbo Defrost (pages 17-18)	 →  →  Press once. Set the weight Press once.	
To Use Grill (pages 19-20)	 →  →  Press once. Select the power level Press once.	
	 →  Set the cooking time Press once.	

Quick Guide to Operation

(continued)

English

<p>To Use Oven (pages 21-22)</p>	<p>With / Without Preheating:</p> <p>  →  →  Press once. Select the temperature Press once. </p> <p> →  →  →  Press once. Set the cooking time Press once. </p> <p><i>* Skip this step when preheat is not required.</i></p>
<p>To Use as a Kitchen Timer (page 23)</p>	<p>  →  →  Press once. Set the kitchen time Press once. </p>
<p>To Set Standing Time (page 23)</p>	<p> Set the desired cooking program →  →  →  Press once. Set the standing time Press once. </p>
<p>To Set Delay Start (page 23)</p>	<p>  →  → Set the desired cooking program →  Press once. Set the delay time Press once. </p>
<p>To Set Add Time (page 25)</p>	<p>  →  After cooking, press this pad to select Add Time function. Press once. </p>
<p>To Use Sensor Reheat (page 26)</p>	<p>  →  → * Press once. Press once. Optional* </p>
<p>To Use Cleaning Program (page 27)</p>	<p>  →  →  →  Press once. Select "F1". Press once. Press once. </p>
<p>To Use Auto Cook (page 28)</p>	<p>For menus 1-9 (Without Preheating); For menus 10-20 (With Preheating)</p> <p>  →  →  Press once. Select the desired auto menu. Press once. </p> <p> →  →  →  Press once. Set the desired weight Press once. </p> <p><i>* Skip this step when preheating is not required.</i> <i>* Skip this step for menu 16-20.</i></p>

IMPORTANT SAFETY INSTRUCTIONS

READ CAREFULLY AND KEEP FOR FUTURE REFERENCE

English

Precautions to be taken when using Microwave Ovens for Heating Foodstuffs INSPECTION FOR DAMAGE:

A microwave oven should only be used if an inspection confirms all of the following conditions:

1. The door fits squarely, securely and opens and closes smoothly.
2. The door hinges are in good condition.
3. The metal plates of a metal seal on the door are neither buckled nor deformed.
4. The door seals are neither covered with food nor have large burn marks.

PRECAUTIONS:

Microwave radiation from microwave ovens can cause harmful effects if the following precautions are not taken:

1. Never tamper with or deactivate the interlocking devices on the door.
2. Never poke an object, particularly a metal object, between the door and the oven while the oven is operating.
3. Never place saucepans, unopened cans or other heavy metal objects in the oven.
4. Do not let other metallic articles, e.g. fast food foil containers, touch the side of the oven.
5. Clean the oven cavity, the door and the seals with water and a mild detergent at regular intervals. Never use any form of abrasive cleaner that may scratch or scour surfaces around the door.
6. Do not use harsh abrasive cleaners or sharp metal scrapers to clean the oven door glass, since they can scratch the surface, which may result in shattering of the glass.
7. Always use the oven with the cookware recommended by the manufacturer.
8. Never operate the oven without a load (i.e., an absorbing material such as food or water) in the oven cavity unless specifically allowed in the manufacturer's literature.
9. For horizontally hinged doors, never rest heavy objects such as food containers on the door while it is open.

10. Do not place sealed containers in the microwave oven. Baby bottles fitted with a screw cap or a teat are considered to be sealed containers.
11. This appliance is not intended for use by persons (including children) with reduced physical, sensory or mental capabilities, or lack of experience and knowledge, unless they have been given supervision or instruction concerning use of the appliance by a person responsible for their safety.
12. Children should be supervised to ensure that they do not play with the appliance.
13. It is hazardous for anyone other than a competent person to carry out any service or repair operation that involves the removal of a cover which gives protection against exposure to microwave energy.
14. The surfaces are liable to get hot during use.
15. The appliance must not be installed behind a decorative door in order to avoid overheating.

Practical Hints:

1. For initial use of **Grill** and **Oven**, if you see white smoke arise, it is not a malfunction.
2. Exterior oven surfaces, including air vents on the cabinet and the oven door will get hot during **Grill** and **Oven**. Use with care when opening or closing door and when inserting or removing food and accessory.



Caution! Hot surfaces

3. The oven has heating elements situated in the top and in the base of the oven. After using the **Grill** and **Oven** functions, the ceiling will be very hot.
4. During use the appliance becomes hot. Care should be taken to avoid touching heating elements inside the oven.
5. The accessible parts may become hot when **Grill** and **Oven** is in use. Children should be kept away.
6. Before using **Grill** and **Oven** functions for the first time, operate the oven without food and accessory on **Oven** 200 °C for 10 minutes. This will allow the oil that is used for rust protection to be burned off. This is the only time that the oven is operated completely empty (except when preheating).

IMPORTANT SAFETY INSTRUCTIONS (continued)

Important Instructions

WARNING—To reduce the risk of burns, electric shock, fire, injury to persons or excessive microwave energy:

1. Read all instructions before using the microwave oven.
2. Some products such as whole eggs and sealed containers - (for example, closed glass jars **and sealed baby bottles with teat**) - may explode and should not be heated in the microwave oven.
3. Use this microwave oven only for its intended use as described in this manual.
4. As with any appliance, close supervision is necessary when used by children.
5. Do not operate this microwave oven, if it is not working properly, or if it has been damaged or dropped.
6. Do not store or use this appliance outdoors.
7. Do not immerse cord or plug in water.
8. Keep cord away from heated surfaces.
9. Do not let cord hang over edge of table or counter.
10. To reduce the risk of fire in the oven cavity:
 - (a) Do not overcook food. Carefully attend microwave oven if paper, plastic, or other combustible materials are placed inside the oven to facilitate cooking.
 - (b) Heating therapeutic wheat bags is not recommended. If heating, do not leave unattended and follow manufacturers' instructions carefully.
 - (c) Remove wire twist-ties from bags before placing bag in oven.
 - (d) If materials inside the oven should ignite, keep oven door closed, turn oven off at the wall switch, or shut off power at the fuse or circuit breaker panel.
 - (e) Never leave microwave unattended while cooking or reheating.
11. Do not remove outer panel from oven.
12. Appliances are not intended to be operated by means of an external timer or separate remote-control system.
13. The oven should be cleaned regularly and any food deposits removed.
14. Failure to maintain the oven in a clean condition could lead to deterioration of the surface that could adversely affect the life of the appliance and possibly result in a hazardous situation.

Circuits

Your microwave ovens should be operated on a separate circuit from other appliances. The voltage used must be the same as specified on this microwave oven. Failure to do this may cause the power board fuse to blow, and/or food to cook slower. Do not insert higher value fuse in the power board.

Earthing Instructions

This microwave oven must be earthed. In the event of an electrical short circuit, earthing reduces the risk of electric shock by providing an escape wire for the electric current. This microwave oven is equipped with a cord having an earthing wire with an earthing plug. The plug must be plugged into an outlet that is properly installed and earthed.

WARNING—Improper use of the earthing plug can result in a risk of electric shock.

Fan Motor Operation after Cooking

After using this oven, the fan may rotate to cool the electric components. This is perfectly normal, and you can take out the food from the oven while the fan operates.

After using **Oven** mode, it is recommended to open the door of the oven to accelerate the cooling down process and shorten fan running time.

IMPORTANT SAFETY INSTRUCTIONS (continued)

English

WARNING

- a) The door seals and door seal areas should be cleaned with a damp cloth. The appliance should be inspected for damage to the door seals and door seal areas and if these areas are damaged the appliance should not be operated until it has been repaired by a qualified service technician trained by the manufacturer.
- b) If the door or door seals are damaged, the oven must not be operated until it has been repaired by a competent person.
- c) It is dangerous for anyone other than a service technician trained by the manufacturer to perform repair service.
- d) It is hazardous for anyone other than a competent person to carry out any service or repair operation that involves the removal of a cover which gives protection against exposure to microwave energy.
- e) If the supply cord is damaged, it must be replaced by the manufacturer, its service agent or similarly qualified persons in order to avoid a hazard.
- f) Before use, the user should check that whether the utensils are suitable for use in microwave ovens.
- g) Liquids or other foods must not be heated in sealed containers since they are liable to explode, at the same time, it should avoid the boiling liquids splash.
- h) Only allow children to use the oven without supervision when adequate instructions have been given so that the child is able to use the oven in a safe way and understands the hazards of improper use.
- i) When the appliance is operated in the Grill or Oven modes, children should only use the oven under adult supervision due to the temperatures generated.

Installation and General Instructions

General Use

1. In order to maintain high quality, do not operate the oven when empty. The microwave energy will reflect continuously throughout the oven if no food or water is present to absorb energy. This can lead to damage to the microwave oven including arcing within the oven cavity.
2. If smoke is observed, tap **Stop/Cancel** and leave door closed in order to stifle any flames. Disconnect the power cord, and/or shut off power at the fuse or circuit breaker panel.
3. The microwave oven is intended for heating food and beverages. Drying of food or clothing and heating of warming pads, slippers, sponges, damp cloth and similar may lead to risk of injury, ignition or fire.
4. Do not dry clothes, newspapers or other materials in oven. They may catch on fire.
5. Do not use recycled paper products, unless the paper product is labelled as safe for microwave oven use. Recycled paper products may contain impurities which may cause sparks and/or fires when used.
6. Do not use newspapers or paper bags for cooking.
7. Do not hit or strike control panel. Damage to controls may occur.
8. POT HOLDERS may be needed as heat from food is transferred to the cooking container and from the container to the oven. The oven can be very hot after removing the cooking container from the oven.
9. Do not store flammable materials next to, on top of, or in the oven. It could be a fire hazard.
10. Do not cook food directly on the base of oven unless indicated in recipes. (Food should be placed in a suitable cooking utensil.)
11. **DO NOT** use this oven to heat chemicals or other non-food products. **DO NOT** clean this oven with any product that is labelled as containing corrosive chemicals. **The heating of corrosive chemicals in this oven may cause microwave radiation leaks.**
12. When using the **Microwave** mode, never place any aluminum or metal containers directly on the Enamel Tray.
13. Do not use the Enamel Tray when cooking in the **Microwave** mode only.
14. During cooking, some steam will condense inside and/or on the oven door. This is normal and safe. Steam will disappear after the oven is cool down.
15. Do not leave the microwave unattended while reheating or cooking food in disposable containers made of plastic, paper or other combustible materials, as these types of containers can ignite if overheated.
16. Metallic containers for food and beverages are not allowed during microwave cooking.
17. Only use utensils that are suitable for use in microwave ovens.

Installation and General Instructions (continued)

Placement of the Oven

This oven is intended for Counter-top use only. It is not intended for built-in use or use inside a cupboard. The appliance shall not be placed in a cabinet.

1. The oven must be placed on a flat, stable surface, more than 85 cm above the floor. For correct operation, the oven must have sufficient air flow, i.e. **5 cm at one side, the other being open; 25 cm clear over the top; 10 cm at the rear. Do not remove feet.**

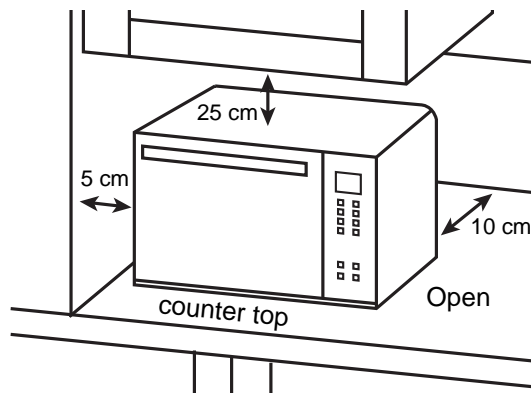

- (a) Do not block air vents. If they are blocked during operation, the oven may overheat. If the oven overheats, a thermal safety device will turn the oven off. The oven will remain inoperable until it has cooled.
 - (b) Do not place oven near a hot or damp surface such as a gas stove, electric range or sink etc.
 - (c) Do not operate oven when room humidity is too high.
2. This oven was manufactured for household use only.

Food

1. Do not use your oven for home canning or the heating of any closed jar. Pressure will build up and the jar may explode. In addition, the microwave oven cannot maintain the food at the correct canning temperature. Improperly canned food may spoil and be dangerous to consume.
2. Do not attempt to deep fat fry in your microwave oven.
3. Eggs in their shell and whole hard-boiled eggs should not be heated in microwave ovens since they may explode, even after microwave heating has ended.
4. Potatoes, apples, egg yolks, chicken wings, whole squash and sausages are examples of foods with nonporous skins. This type of food must be pierced before cooking, to prevent bursting.
5. When heating liquids, e.g. soup, sauces and beverages in your microwave oven, overheating the liquid beyond boiling point can occur without evidence of bubbling. This could result in a sudden boil over the hot liquid. To prevent this possibility the following steps should be taken:
 - (a) Avoid using straight-sided containers with narrow necks.
 - (b) Do not overheat.
 - (c) Stir the liquid before placing the container in the oven and again halfway through cooking time.
 - (d) After heating, allow to stand in the oven for a short time, stirring again before carefully removing the container.
 - (e) Microwave heating of beverages can result in delayed eruptive boiling, therefore care must be taken when handling the container.
 - (f) As a general rule, always cover wet foods, e.g. soups, casseroles and plated meals.
6. **DO NOT USE A CONVENTIONAL MEAT THERMOMETER IN THE MICROWAVE OVEN. To check the degree of cooking of roasts and poultry use a MICROWAVE THERMOMETER.** Alternatively, a conventional meat thermometer may be used after the food is removed from the oven. If undercooked, return meat or poultry to the oven and cook for a few more minutes at the recommended power level. It is important to ensure that meat and poultry are thoroughly cooked.

Installation and General Instructions (continued)

- 7. COOKING TIMES given in the Cooking Guide section are APPROXIMATE.** Factors that may affect cooking time are preferred degree of moisture content, starting temperature, altitude, volume, size, shape of food and utensils used. As you become familiar with the oven, you will be able to adjust for these factors.
- 8. It is better to UNDERCOOK RATHER THAN OVERCOOK foods.** If food is undercooked, it can always be returned to the oven for further cooking. If food is overcooked, nothing can be done. Always start with minimum cooking times recommended.
- 9.** Extreme care should be taken when cooking popcorn in a microwave oven. Cook for minimum time as recommended by manufacturer. Use the directions suitable for the wattage of your microwave oven. NEVER leave oven unattended when popping popcorn.
- 10.** When heating food in plastic or paper containers, keep an eye on the oven due to the possibility of ignition.
- 11.** The contents of feeding bottles and baby food jars are to be stirred or shaken and the temperature is to be checked before consumption, in order to avoid burns.

Microwaves and How They Work

MICROWAVE COOKING

Microwaves are a form of high frequency electromagnetic waves (app. 12 cm wave length) similar to those used by a radio. Electricity is converted into microwave energy by the magnetron tube. The microwaves travel from the magnetron tube to the oven cavity where they are reflected, transmitted or absorbed.

Reflection

Microwaves are reflected by metal just as a ball is bounced off a wall. A combination of stationary (interior walls) and rotating metal (turntable or stirrer fan) helps assure that the microwaves are well distributed within the oven cavity to produce even cooking.

Transmission

Microwaves pass through some materials such as paper, glass and plastic much like sunlight shining through a window. Because these substances do not absorb or reflect the microwave energy, they are ideal materials for microwave oven cooking containers.

Absorption

Microwaves are absorbed by food. They penetrate to a depth of about 2 to 4 cm.

Microwave energy excites the molecules in the food (especially water, fat and sugar molecules), and causes them to vibrate very quickly.

The vibration causes friction and heat is produced. In large foods, the heat which is produced by friction is conducted to the center to finish cooking the food.

MICROWAVE COOKING UTENSILS

Microwave cooking opens new possibilities in convenience and flexibility for cooking containers. Although new microwave accessory are constantly being introduced, many utensils readily available in most kitchens may also be used for microwave cooking and heating.

Glass, Ceramic and China

Heat-Resistant glass cookware is invaluable in microwave cooking. Many of these items are readily available in most homes: glass measures, custard cups, mixing bowls, loaf dishes, covered casseroles, oblong baking dishes, pie plate and round or square cake dishes.

Dinnerware can be used for microwave heating. Many brands of dinnerware are microwave safe. Check the care information for reference to microwave use for dinnerware and serving pieces.

If dinnerware is marked ovenproof, it is safe to use it frequently in the microwave oven. However, to be sure, check by conducting microwave dish test.

Several types of glassware and dinnerware are not recommended for use in the microwave oven.

Remember these basic rules when using dinnerware and glassware. Do not use dishes with metallic trim or containers with metal parts. Arcing may occur and/or the dish may break.

Do not use ceramic mugs or cups with glued-on handles. The handles may fall off with continued heating.

Do not use delicate glassware.

Although the glassware may be transparent to microwave energy, the heat from the food may cause the glassware to crack.

HOW TO TEST A CONTAINER FOR SAFE MICROWAVE OVEN USE:

Fill a 300 ml (½ pt.) glass measure with water and place it in the microwave oven along with the container to be tested; heat one minute at 1000 W, if the container is microwave oven safe, it should remain comfortable cool and the water should be hot. If the container is warm, it has absorbed some microwave energy and should not be used. This test cannot be used for plastic containers which should be dishwasher safe.

Microwaves and How They Work (continued)

Jars and Bottles can be used to warm food to serving temperature, if the lid is removed first. Cooking should not be done in these containers since most are not heat-resistant and during extended heating times, heat from food would cause cracking or breaking.

Browning Dishes are used to sear chops, meat patties, steaks etc. A special coating on the bottom of the dish absorbs the microwave energy and becomes very hot. When foods are added to the dish, the result is a seared effect. Preheat dish according to manufacturer's directions. Add food to be seared and heat according to recipe or personal preference. Use pot holders to remove dish from microwave oven. Do not use browning dish on Auto Menu. Check information included with browning dish for detailed instructions and heating chart.

Do not use browning dish for roasting or whole poultry.

Paper, Napkins, Paper Towels, Plates and Cups

All are handy utensils for microwave cooking. Use them for foods with short cooking times and low fat content.

Avoid wax coated paper goods, since the wax may melt onto the food when the food reaches high temperatures.

Waxed paper is suitable to use to prevent splatter. Disposable polyester coated paperboard pans are sturdy, come in a variety of sizes and are ideal for microwaving.

CAUTION: DO NOT use recycled paper products, such as brown paper bags, since they contain impurities which may cause arcing (blue sparks) and damage the oven.

Straw, Wicker and Wood

Straw and wicker baskets may be used in the microwave oven for short periods of time to warm rolls or bread.

Large wooden utensils such as bowls or cutting boards should NOT be used for prolonged heating as the microwave energy may cause the wood to become dry and brittle.

Plastic Dishes, Cups and Some Freezer Containers

may be used in the microwave oven. Choose plastic containers carefully since some can become soft, distorted or pitted from the heat of the food. Check manufacturer's recommendations concerning microwave safety. Plastic dishes should not be used for cooking over an extended period of time or with foods having high fat and sugar content.

Cooking Bags designed to withstand boiling, freezing, or conventional heating are microwave safe. Prepare bags according to manufacturer's directions. Close cooking bag with nylon tie provided, otherwise, use a piece of cotton string, or a strip cut from the open end of the bag. Make six 1 cm (½ in.) slits in the top of bag to allow steam to escape. DO NOT use wire twist-tie to close bag. They can act as an antenna and cause arcing (blue sparks). Wire twist-ties could ignite and damage the oven. DO NOT cook in plastic

food storage bags. They are not heat-resistant and may melt. Do not use roaster bags on Auto Sensor programmes.

Plastic Wrap (cling film) can be used to cover dishes in most recipes. Over an extended heating time, some disfiguration of the wrap may occur.

When using cling film "covers," as well as any glass lid, be careful to remove it away from you to avoid steam burns. After heating, loosen plastic but let dish stand covered.

For Auto Sensor Cooking do not turn back corners of cling film covers.

Metal containers or utensils, and those with metallic trim, should NOT be used in the microwave oven. Since microwave energy is reflected by metal, foods in metal containers will not cook evenly.

There is also the possibility of "arcing". This is a static discharge or blue spark between gaps in the metal or between the metal and the interior of the oven. Arcing may cause damage to the oven walls. If arcing occurs, turn the unit off and transfer food to a non-metallic container.

Although metal utensils must be avoided in microwave cooking, some metal can be helpful when used correctly.

Aluminium Foil can be used safely if certain guidelines are followed.

Because it reflects microwave energy, foil can be used to an advantage in some recipes. It can be used to prevent overcooking. Small pieces of foil are used to cover areas such as chicken wings, tips of roasts, or other thin parts that cook before the rest of the recipe is finished. Foil is used in these cases to slow or stop the cooking process and prevent overcooking.

Pieces of foil can be held in position with pieces of wooden cocktail sticks.

Foil Lined Containers, either cardboard or plastic, should NOT be used in the microwave oven. Foil lined milk cartons, frozen orange juice concentrate containers, or baking containers, included in some cake mixes are examples of things to be avoided.

Metal Skewers can be used if there is a large amount of food in proportion to the amount of metal. Take care in the placement of the skewers to avoid arcing between the skewers or between the skewers and the sides of the oven.

Wooden skewers are the best and can be easily purchased at your local market, grocery store, or in the housewares section of many department stores.

Thermometers are available for use in microwave ovens. DO NOT USE CONVENTIONAL MERCURY TYPE CANDY OR MEAT THERMOMETERS in food while heating in the microwave oven.

Metal Twist-Ties either paper or plastic coated, should NOT be used in the microwave oven.

Feature Diagram

English

Front View

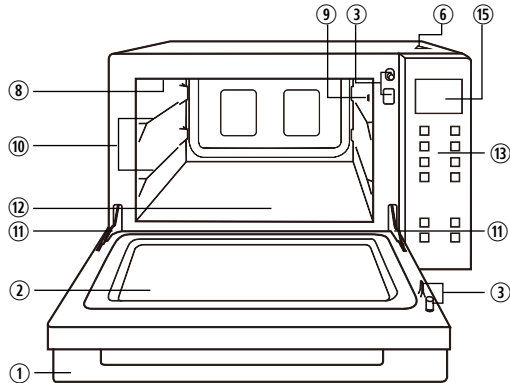

Rear View

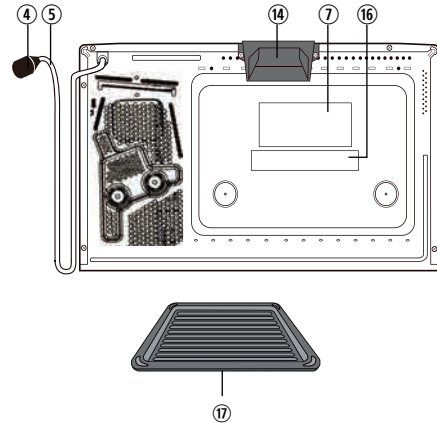

① **Door handle**

Pull the door handle downwards to open. When you open the oven door during cooking, the cooking is stopped temporarily without clearing the programmed settings. The cooking is resumed as soon as the door is closed and the Start/Set pad is pressed. The oven lamp lights as soon as the oven door is opened.

② **Oven window**

③ **Door safety lock system**

To prevent injury, do not insert finger, knife, spoon or other object into the latch hole.

④ **Power supply plug**

⑤ **Power supply cord**

⑥ **Warning symbol**

⑦ **Warning label (Some areas may have two warning labels at the back of oven.)**

⑧ **Grill elements**

⑨ **LED lights**

The oven lamp lights as soon as the oven door is opened.

⑩ **Shelf positions**

⑪ **Door hinges**

To prevent injury when opening or closing the door, keep fingers away from the door hinges.

⑫ **Flat Table**

1. Clean the flat table after cooling.
2. Do not directly place the food on the flat table. Place it on a container or container rack special for the microwave oven.

⑬ **Control panel**

⑭ **Air vent exhaust**

⑮ **Display window**

⑯ **Identification label**

⑰ **Enamel Tray**

1. Place the enamel tray on the shelves.
2. Take it out with thermal insulation gloves after use. To avoid scalding, do not touch it with your hands.
3. The maximum weight that can be used on the oven accessories is 3.2 kg.

Note: Enamel Tray and Metallic Container cannot be applied when using microwave function.

Note:

The above illustration is for reference only.

Control Panel

The control panels have the same layout and function, despite the display of language may be different.

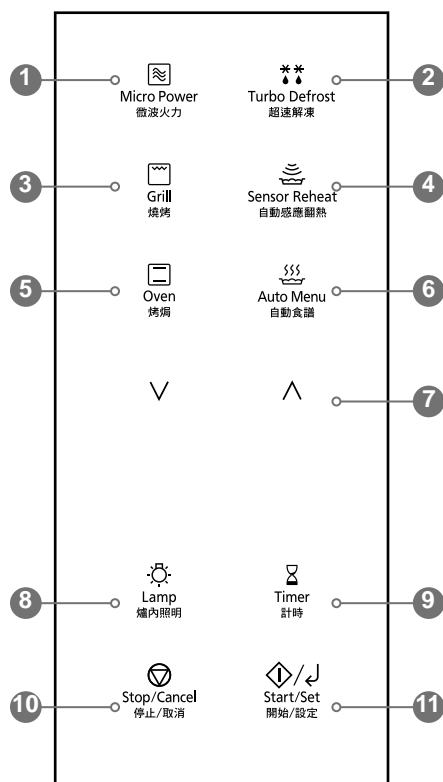

1. **Micro Power** (pages 16-17)
2. **Turbo Defrost** (pages 17-18)
3. **Grill** (pages 19-20)
4. **Sensor Reheat** (page 26)
5. **Oven** (pages 21-22)
6. **Auto Menu** (pages 27-33)
7. **Up/Down Selection** (page 12)
Select the power, temperature, time, weight or auto menu by tapping “v” / “^”.
8. **Lamp** (page 15)
9. **Timer** (page 23)
10. **Stop/Cancel**
Before cooking:
One tap clears your instructions.
During cooking:
One tap temporarily stops the cooking program.
Another tap cancels all your instructions and “0” will appear in the display.
11. **Start/Set**

Beep sound

A beep sounds when a key is tapped. If this beep does not sound, you may have turned off the beep choice, you can turn it on by tapping **Start/Set** Pad once then tapping “v” / “^” after first plugged in, (see page 15). When the oven changes from one function to another or remind you to stir food during cooking, two beeps sound. After the completion of the preheating on oven, three beeps sound. After completion of the preheating on some auto menus, a long beep sounds. After completion of cooking, five beeps sound.

Note:

If an operation is set and the **Start/Set** is not pressed within 6 minutes, the oven will automatically cancel the operation. The display will revert back to “0”.

Up/Down Selection

Select the power, temperature, time, weight or auto menu by tapping “√” / “^”. The power, temperature, time, weight or auto menu number appears in the display window. The time/weight/temperature can be adjusted quickly by holding pad.

English

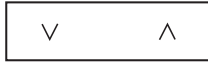

1 Power/Temperature/Time/Weight/Auto Menu Selection:
Select the power, time, weight, temperature or auto menu by tapping “√” / “^”.

2 Add Time Selection:
Use the pad for the Add Time Function (see page 25)



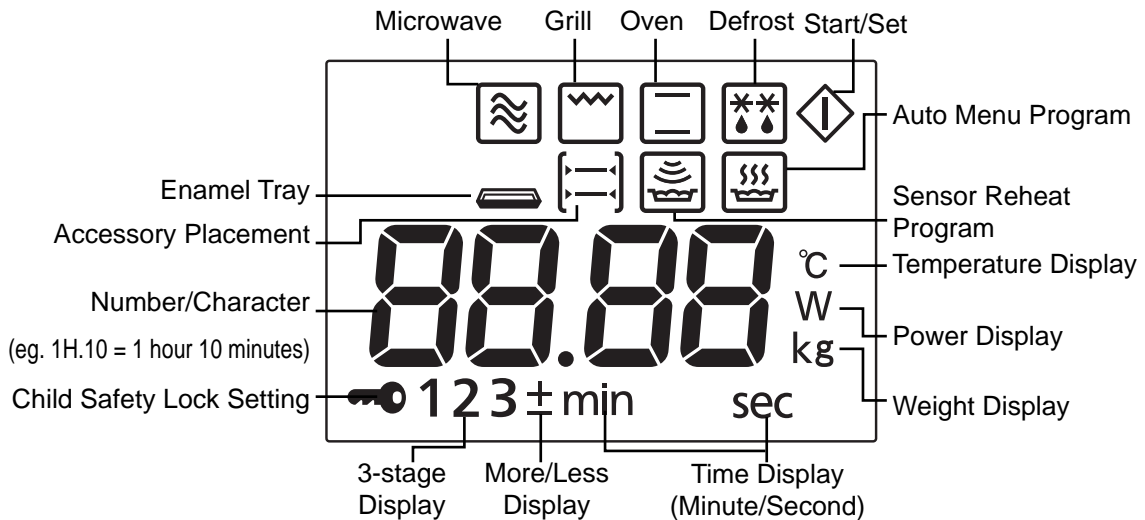

3 More/Less Selection:
To set more/less for Sensor Reheat (see page 26).

Display Window

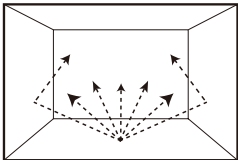
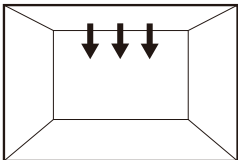

Cooking Modes

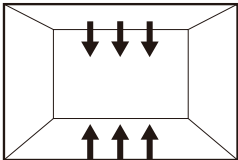
The diagrams shown below are examples of the accessories. It may vary depending on recipe/dish used. The icon " " in below chart means Enamel Tray.

Cooking modes	
<p>MICROWAVE</p>  <p>Accessory -</p>	<p>Uses</p> <ul style="list-style-type: none"> ■ Defrosting ■ Reheating ■ Melting: butter, chocolate, cheese. ■ Cooking fish, vegetables, fruits, eggs. ■ Preparing: stewed fruits, jam, sauces, custards, choux, pastry, caramel, meat, fish. ■ Baking cakes without colour. <p>No preheating</p> <hr/> <p>Containers</p> <p>Use your own Pyrex® dishes, plates or bowls, directly on the base of the oven. Microwaveable, no metal.</p>
<p>GRILL</p>  <p>Accessory </p>	<p>Uses</p> <ul style="list-style-type: none"> ■ Grilling of meat or fish. ■ Toast grilling. ■ Colouring of gratin dishes or meringue pies. <p>No preheating</p> <hr/> <p>Containers</p> <p>Heatproof, metal tin can be used on Enamel Tray in lower or upper shelf positions.</p>
<p>OVEN</p>  <p>Accessory </p>	<p>Uses</p> <ul style="list-style-type: none"> ■ Baking of small items with short cooking times: puff pastry, cookies, roll cakes, scones. ■ Special baking: bread rolls or brioches, sponge cakes. ■ Baking of pizzas and tarts. <p>Preheating advised</p> <hr/> <p>Containers</p> <p>Heatproof, metal tin can be used on Enamel Tray in lower or upper shelf positions. Do not place foods directly on base of oven.</p>

English

Cookware and Utensil Chart

English

	Microwave	Grill	Oven
Enamel Tray	no	yes	yes
Aluminium foil	no	yes	yes
Ceramic Plate	yes	yes	yes
Browning Dish	yes	no	no
Brown paper bags	no	no	no
Dinnerware oven/microwave safe	yes	yes	yes
Non-oven/microwave safe	no	no	no
Disposable paperboard containers	yes*	yes*	yes*
Glassware oven glassware & ceramic	yes	yes	yes
Non-heat resistant	no	no	no
Metal cookware	no	yes	yes
Metal twist-ties	no	yes	yes
Oven cooking bag	yes	yes*	yes*
Paper towels and napkins	yes	no	no
Plastic defrosting rack	yes	no	no
Plastic dishes microwave safe	yes	no	no
Non-microwave safe	no	no	no
Microwave safe cling film	yes	no	no
Straw, wicker, wood	yes	no	no
Thermometers microwave safe	yes	no	no
conventional	no	yes	yes
Waxed paper	yes	yes	yes
Silicon bakeware	yes*	yes*	yes*

* Check manufacturers' recommendation, must withstand heat or follow the recipe instructions.

Beep Choice

The oven has both "Beep On" and "Beep Off" mode. This unique function of your Panasonic microwave oven allows you to establish the initial non-cooking features of your oven.



1. **Press the Start/Set pad after first plugged in.**
"bBEEP" appears in the display window. The default mode is "On".
2. **Press Up/Down Selection pad.**
The mode changes to "OFF".
3. **After setting, tap Stop/Cancel pad to exit.**

Notes:

1. The choice can be selected only when you plug-in the oven.
2. Tap **Up/Down Selection** pad, it will revert to initial mode.

Child Safety Lock Setting

Using this system will make the oven controls inoperable; however, the door can be opened. Child lock can be set when the display shows a "0".

To set:



To cancel:



Note:

To set or cancel child safety lock, **Start/Set** pad or **Stop/Cancel** pad must be pressed 3 times within 10 seconds.

Oven Lamp

To turn on/off the oven lamp.



Press the Lamp pad to turn on/off the oven lamp.

Note:

This feature is not available in child safety lock mode.

Micro Power Setting

There are 6 different microwave power levels available. Do not place food directly on the base of the oven. Use your own dishes, plates or bowls covered with a lid or pierced cling film directly on the base of the oven.

English



1. Press **Micro Power** pad once. The microwave symbol "☰" will appear.



2. Select the power level. Press the "∨" / "∧" until the power you require appears in the display window. (see below chart)



3. Press the **Start/Set** pad to confirm the selection.

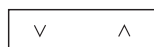

4. Select the cooking time by pressing the "∨" / "∧".
(High Power: up to 30 minutes)
(Other Powers: up to 1 hour 30 minutes)



5. Press the **Start/Set** pad to start. The cooking program will start and the time in the display will count down.

Power Level	Example of Use
1000 W (High)	Boil water. Cook fresh fruits, vegetables, preserved fruit and candies.
800 W (Med High)	Cook fish and seafood, meat, poultry, eggs and cakes.
600 W (Medium)	Cook cakes, stew food, melt butter and chocolate.
440 W (Low)	Cook tough meat, stew soup and soften butter.
270 W (Defrost)	Defrost meat, poultry or seafood.
100 W (Warm)	Keep food warm and soften ice cream.

Notes:

1. You can change the cooking time during cooking if required. Press the "∨" / "∧" to increase or decrease the cooking time. Time can be increased/decreased in 1 minute increments, up to 10 minutes.
2. Do not attempt to use microwave only with any metal container in the oven.
3. Do not place food directly onto the base of the oven. Place in a microwaveable or glass dish. Foods reheated or cooked by microwave only should be covered with a lid or pierced cling film, unless otherwise stated.
4. For 3-stage cooking refer to page 24.
5. Standing time can be programmed after microwave power and time setting. Refer to using the timer page 23.

Micro Power Defrost Setting

This feature allows you to defrost by setting time by yourself.



1. Press **Micro Power** pad once. The microwave symbol "☼" will appear.



2. Press the "v" / "^" until 270 W appears in the display window. ("☼" and "270" will appear.)



3. Press the **Start/Set** pad to confirm the selection.

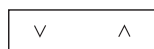

4. Select the cooking time by pressing the "v" / "^".
(Maximum cooking time: up to 1 hour 30 minutes)



5. Press the **Start/Set** pad to start.
The cooking program will start and the time in the display will count down.

Notes:

1. Opening the door and taking out the defrosted parts during the operating time is recommended. Turn over, stir or rearrange the parts which are still in icy.
2. For manual defrosting times, please refer to defrosting chart on pages 34.
3. Please use plastic wrap or lids when defrosting.

Turbo Defrost Setting

This feature allows you to defrost meat, poultry and seafood automatically by just setting the weight. The serving/weight is 100 g to 2000 g.



1. Press **Turbo Defrost** pad once.



2. Select the required weight by pressing the "v" / "^".



3. Press the **Start/Set** pad to start.
The defrosting program will start and the time in the display will count down.

Notes:

1. Turbo Defrost can be used to defrost many cuts of meat, poultry and fish by weight. The oven will determine the defrosting time and power levels. Once the oven is programmed, the defrosting time will appear in the display. For best results the minimum recommended weight is 200 g.
2. Turn over the food, remove defrosted food and shield thin ends/fat bones of roast with foil when buzzer rings in the middle of cooking.
3. The shape and size of the food will determine the maximum weight the oven can accommodate.
4. Allow standing time to ensure the food is completely defrosted.
5. If 'HOT' appears in the display window, the oven temperature is too high from previous use and an auto program can not be set. Cooking mode and time may still be set manually.

Defrosting Tips and Techniques

Preparation for Freezing

The quality of the cooked foods comes from the foods before freezing, freezing ways and defrosting tips and times. So it is important to purchase fresh and high quality foods. And freeze them immediately. Thick plastic foil, package, freezing wrap and the meat which has been sealed before selling are all able to be reserved in the refrigerator for some times.

Note:

1. When freezing meats, poultry and fish or seafood, the foods should be arranged evenly and wrap as 2.5 cm - 5 cm square or a round shape.
2. Please clean the whole chicken before freezing. (The bowels can be frozen individually.) Clean the whole chicken and make it dry. Binding the leg and thigh.
3. Remove all air and seal securely. Label package with type and cut of meat, date and weight.
4. Please remove the aluminum foil if the package is made of aluminum to prevent arcing.
5. The foods in the refrigerator should be kept under -18 °C. (At least 24 hours in freezer before defrosting.)

Turbo Defrost

The Turbo defrost function is operated based on the weight of foods. Most cut foods such as chicken, meat and fish can be defrosted by using this function easily. Set weight based on the real weight of foods, and the microwave oven will set the power and time automatically. The display window will display the time of defrost after setting. The foods listed in the below table are the most suitable for using defrost function. The minimize weight is 100 g and the maximum is 2000 g for getting the best result.

Foods	The maximum weight for the foods
Meat loaf, chicken, rib	2000 g
Beef, lamb, whole chicken	2000 g
Whole fish, shellfish, prawn and fish fillet	1000 g

Tips for Turbo defrost

Meat, which is with bones. For example, if the meat with bones has the same weight as the pure meat, the meat in the former one is lighter than the latter one. So, subtract 500 g for 2000 g meat with bones is better for defrosting and 200 g - 300 g for meat with bones which is less than 2000 g.

Two buzz beeps

Turn over the meat, chicken, fish and shellfish. Separate the stewed meat, chicken pieces and meat loaf. Apart the meat loaf from the hamburger. Shield the edge of chicken wings, roast, fat or bones.

Key to defrosting

For evenly defrosting, turn over the foods or move the position of the foods in the containers during the progress of defrosting.



Remove the package of the raw meat and place it on the plate.



Shield the front part of the chicken drumsticks by using aluminum foil.

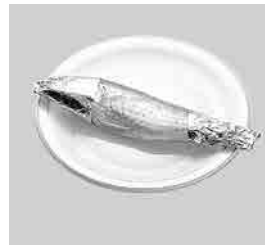

Shield the head and tail of the whole fish by using aluminum foil.

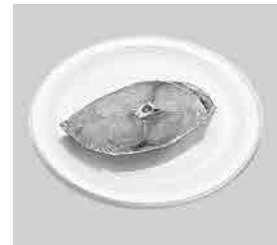

Remove the package of the fish fillet and place it on the plate.

Grill Setting

The grill system on the oven gives fast efficient cooking for a wide variety of foods e.g. chops, sausages, steaks, toast, etc.

English



1. Press **Grill** pad once.



2. Select the power level.
Press the “V” / “^” until the power you require appears in the display window. (see below chart)



3. Press the **Start/Set** pad to confirm the selection.

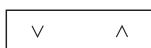

4. Select the cooking time by pressing the “V” / “^”.
(Maximum cooking time is 1 hour and 30 minutes)



5. Press the **Start/Set** pad to start.
The cooking program will start and the time in the display will count down.

Power Level	Suitable kinds of foods
Grill 1 (Low)	Slice of poultry or meat
Grill 2 (Medium)	Thin seafood
Grill 3 (High)	Bread and toast

Oven Accessories to Use

When grilling fish, chops or small food items, the Enamel Tray should be placed in the upper shelf position. For larger food items, the Enamel Tray should be in the lower shelf position.

Place food on Enamel Tray

The Enamel Tray will allow fat and juices to drip into the watercourse to reduce excess splatter and smoke when grilling.

Most foods require turning halfway during cooking. When turning food, open oven door and carefully remove the Enamel Tray by holding firmly.

After turning, return food to the oven, close door and press the **Start/Set** pad to start. The oven will continue to count down the remaining cooking time. It is quite safe to open the oven door at any time to check the progress of the food as it is grilling.



For grilling small foods use the Enamel Tray in the upper shelf position.

Notes:

1. You can change the cooking time during cooking if required. Pressing the “√” / “^” to increase or decrease the cooking time. Time can be increased/ decreased in 1 minute increments, up to 10 minutes.
2. There is no microwave power on the **Grill** only program.
3. Use the Enamel Tray provided, as explained.
4. The **Grill** will only operate with the oven door closed.
5. Most meat items e.g. bacon, sausages, chops can be cooked on the hottest setting **Grill 3**. This setting is also suitable for toasting bread, muffins and teacakes etc.
6. **Grill 2** and **Grill 1** are used for more delicate foods or those that require a longer grill time e.g. fish or chicken portions.
7. **Never cover the food when grilling.**
8. The Enamel Tray and surrounding oven will get very hot. Use oven gloves.
9. After grilling, it is important that the Enamel Tray is removed for cleaning before reuse and that the oven walls and floor are wiped with a cloth squeezed in hot soapy water to remove any grease.
10. When using the grill to cook foods, the cooking times will be similar to traditional grilling.

Oven Setting

The oven can be used as an oven using the oven mode which uses top and bottom heat. For best results always place food in a preheated oven. When using oven mode, the Enamel Tray can be placed in the upper or lower shelf position.

See individual guidelines on page 22 for recommended use.

Do not pre-heat on oven mode with the Enamel Tray in position.

English

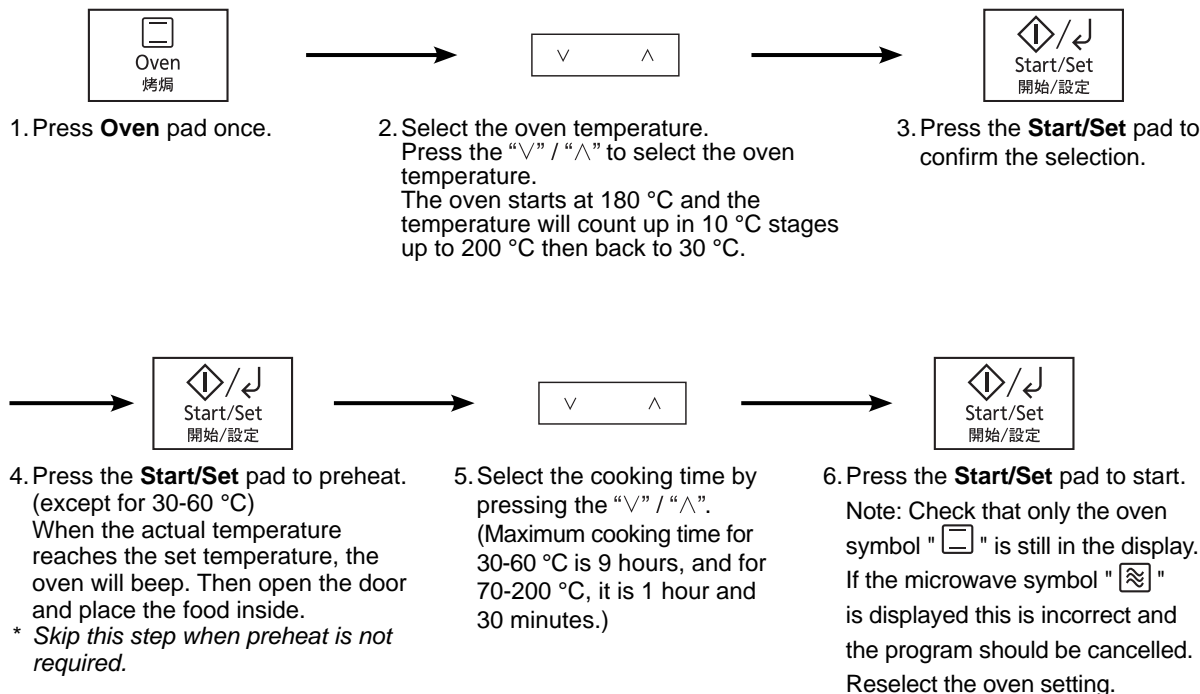

Notes:

1. If the oven has previously been used and it is too hot to ferment dough on 30/40 °C, 'HOT' will appear in the display window. Please wait until the cavity cools down. After the 'HOT' disappears, 30/40 °C may be used again, otherwise you can ferment dough at room temperature.
2. Open the door using the pull down door because if **Stop/Cancel** pad is tapped the program may be cancelled.
3. The oven can not preheat to 30-60 °C.
4. You can change the cooking time during cooking if required. Tapping the “v” / “^” to increase or decrease the cooking time. Time can be increased/decreased in 1 minute increments, up to 10 minutes.
5. The selected temperature can be recalled and changed during cooking and preheating if required. Press **Oven** pad once to indicate the temperature in the display window. You can change the temperature (except 30-60 °C) by pressing the “v” / “^”. While the temperature is recalled in the display window.
6. The oven will maintain the selected preheated temperature for approximately 30 minutes. If no food has been placed inside the oven or a cooking time set, then it will automatically cancel the cooking program and revert to “0”.

Oven Accessory to Use

In oven mode, you can cook food directly on the Enamel Tray in the upper or lower shelf position. Or you can place your standard metal baking tins and ovenware on the Enamel Tray in the lower shelf position. Do not place tins and ovenware directly on the base of the oven in oven mode.

Roasting meat:

Enamel Tray in lower shelf position.



Baking:

Enamel Tray in lower shelf position.



You can use the Enamel Tray for baking dish for roasting potatoes or vegetables, and for baking fairy cakes, scones and cookies. It is also ideal for re-heating pre-baked convenience pastry items.

Roasting Vegetables / Potatoes:

Enamel Tray in lower shelf position.



Reheating:

Enamel Tray in lower shelf position.



Caution: The Enamel Tray and surrounding oven will get very hot. Use oven gloves.

Guideline to Oven Temperatures

For best results always place food in a preheated oven. Don't forget that for ease of programming of the most commonly used temperatures, your oven will start at 180 °C and count up in 10 °C stages to 200 °C then back to 30 °C. Food is generally cooked uncovered - unless it is stated in the instructions or recipe.

Temp °C	Use
30/40 °C	Proving bread or pizza dough
50 °C	Warming dishes
60/70 °C	Dried fruits, beef jerky
80/90 °C	Slow cooking
100 °C	Pavlova
110 °C	Meringues
140 °C	Rich fruit cake
150/160 °C	Macaroons
160/170 °C	Casseroles, small tarts, cookies

Temp °C	Use
180 °C	Victoria sandwich, fairy cakes, meat joints
190 °C	Gratins, lasagne, pastry pies, chicken, Stuffed peppers, scones, swiss roll, muffins
200 °C	Vegetable parcels, bread, garlic bread, Baking pizza, low-oil oven fry cooking for drumsticks, pork chops, and sweet potatoes etc.

Timer Setting (Kitchen Timer/Standing Time/Delay Start)

To Set Kitchen Timer

By using the Timer, you can program the oven as a kitchen timer.



Press **Timer** pad once

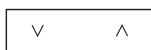

Set the Kitchen timer by pressing the “√” / “^”.
(up to 1 hour and 30 minutes)



Press **Start/Set** pad.
Time will count down without oven operating.

English

To set a standing time:

By using the Timer, you can program standing time after cooking is completed.

Set the cooking program, by entering cooking mode and time required.



Press **Timer** pad once.

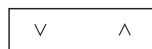

Set desired amount of standing time by pressing the “√” / “^”.
(up to 1 hour and 30 minutes)



Press **Start/Set** pad.
Cooking will start. After cooking, standing time will count down without oven operating.

To Set Delay Start

By using the timer, you are able to program delay start cooking.



Press **Timer** pad once.

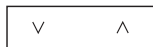

Set desired amount of delay time by pressing the “√” / “^”.
(up to 1 hour and 30 minutes)

Set the cooking program, by entering cooking mode and time required.



Press **Start/Set** pad.
Delay time will count down. Then cooking will start.

Notes:

1. 3-stage cooking can be programmed including kitchen timer, standing time or delay start cooking.
2. If the oven door is opened during the kitchen timer, standing time or delay time, the time in the display window will continue to count down.
3. If the programmed kitchen timer, standing time or delay time exceeds one hour, the time will count down in units of minutes. If less than one hour, the time will count down in units of seconds.
4. Standing time and delay start can not be programmed together with **Auto programs** and **Oven** feature. This is to prevent the starting temperature of food from rising before defrosting or cooking begins. A change in starting temperature could cause inaccurate results and/or food may deteriorate.
5. When using standing time or delay start, it's up to 2 power stages.

3-Stage Setting

This feature allows you to program 3-Stage continually.

E.g.: Continually set [Micro Power "270 W"] 2 minutes, [Micro Power "800 W"] 3 minutes and [Grill "2"] 2 minutes.

English



Press **Micro Power** pad once.



Press the "∨" / "∧" to select 270 W.



Press once to confirm.



Press the "∨" / "∧" to select 2 minutes.



Press the "∨" / "∧" to select 3 minutes.



Press once to confirm.



Press the "∨" / "∧" to select 800 W.



Press **Micro Power** pad once.



Press **Grill** pad once.



Press the "∨" / "∧" to select Grill "2".



Press once to confirm.

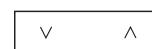

Press the "∨" / "∧" to select 2 minutes.



Press once to start.

Notes:

1. For 3-stage cooking, enter another cooking program before pressing the **Start/Set** pad.
2. During operation, tapping **Stop/Cancel** pad once will stop the operation. Pressing the **Start/Set** pad will re-start the programmed operation. Tapping **Stop/Cancel** pad twice will stop and clear the programmed operation.
3. Whilst not operating, tapping **Stop/Cancel** pad will clear the selected program.
4. **Auto programs and Oven** cannot be used with multi-stage cooking.

Add Time Setting

This feature allows you to add cooking time at the end of previous cooking.



After cooking, press the “∨” / “∧” to select **Add Time** function.

Press the **Start/Set** pad to start. Time will be added. The time in the display window will count down.

English

Modes	Maximum cooking time
Micro Power 1000 W	30 minutes
Other microwave powers, Grill	1 hour and 30 minutes
Oven (30-60 °C)	9 hours
Oven (70-200 °C), Timer	1 hour and 30 minutes

Notes:

1. This function is only available for Micro Power, Grill, Oven and Timer functions and it is not available for Auto programs.
2. The Add Time function is only available within 1 minute after cooking.
3. The Add Time function can be used after the 3-stage cooking. The power level is the same as the last stage.

Sensor Reheat Setting

This feature allows you to reheat foods without entering the weight. The built-in sensor measures the humidity of the food and calculates the recommended microwave power level together with a suggested cooking time.

English



1. Press once.



2. Press once.

After the heat and humidity is detected by the SENSOR, the oven will beep twice, the remaining time appears in the Display Window and begins to count down.



3. Adjust the taste by tapping the “V” / “^” within 14 seconds.
(Optional)

How it Works

Once the Sensor Reheat Program has been selected and **Start/Set** pad tapped the food is heated up. As food begins to get hot, steam is emitted. When the food reaches a certain temperature and begins to cook, an even greater amount of steam is released. The increase in steam emission is detected by a humidity sensor in the oven. This acts as a signal for the oven to calculate how much longer the food needs to reheat. The remaining cooking time will appear in the display window after two beeps. Whilst the sensor reheat program is still in the display window the oven door **should not be opened**. Wait until the cooking time appears in the window, and then open the door if required, to stir or turn the food.

Adjust to Taste

Preferences for degree of cooking vary for each individual. After having used Sensor Reheat Program a few times, you may decide you would prefer your food cooked to a different degree of cooking. After tapping **Start/Set** pad, “±” appears in the display, tap “V” / “^” for more time or for less time. This operation should be completed within 14 seconds. If you are satisfied with the result of the Auto Sensor Reheat Programs, you do not have to use this control.

Notes:

1. This feature is not suitable for foods that cannot be stirred eg. lasagne / macaroni cheese.
2. The oven automatically calculates the reheating time or the remaining reheating time.
3. The door should not be opened before the time appears in the display window.
4. To prevent any mistakes during Sensor Reheat Program ensure that base of oven and the container are dry.
5. The room temperature should not be more than 35 °C and not less than 0 °C.
6. If the oven has previously been used and it is too hot to be used on Sensor Reheat Program, ‘HOT’ will appear in the display window. After the ‘HOT’ disappears, the Sensor Reheat Program may be used. If in a hurry, cook food manually by selecting the correct cooking mode and cooking time yourself.
7. Most foods benefit from a STANDING time, after cooking with an Sensor Reheat Program, to allow heat to continue conducting to the centre.
8. To allow for some variations that occur in food, check that food is thoroughly cooked and piping hot before serving.

Cleaning Setting

F1. Cleaning Program

This feature is recommended for eliminating any odours from the oven.

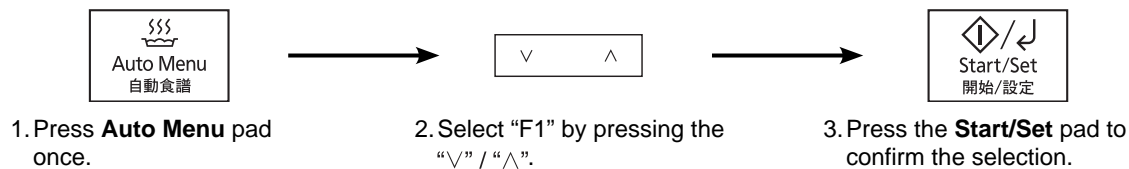

English

Auto Cook Setting and Menus

This feature allows you to cook some of your favourite foods by setting the weight only. Select the category and set the weight of the food. The weight is programmed in grams. For quick selection, the weight starts from the most commonly used weight for each category.

English

For menus 1-9 (Without Preheating); For menus 10-20 (With Preheating)

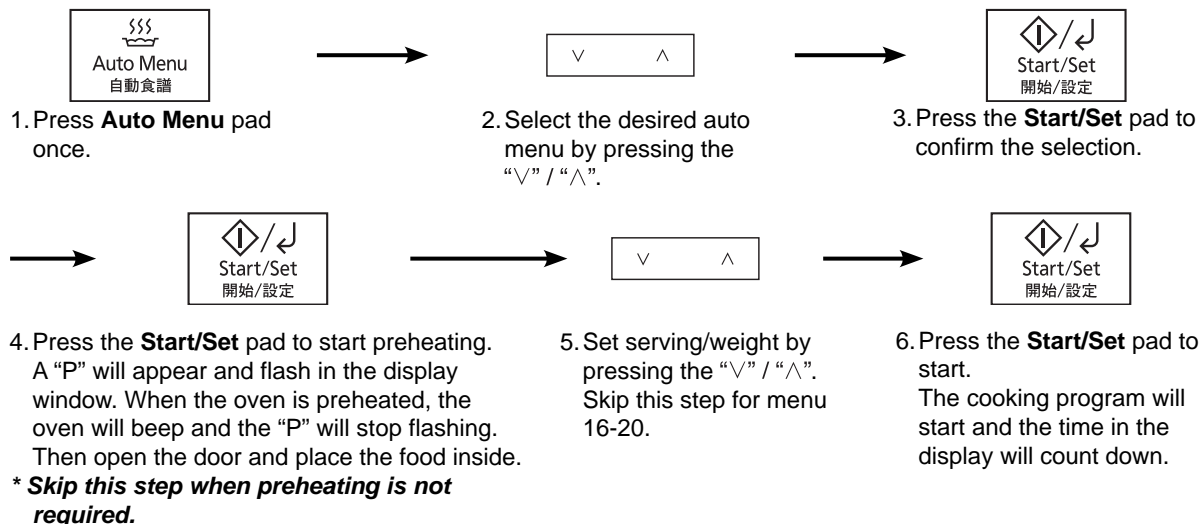

When you select an automatic program, symbols will appear in the display to show the cooking mode that will be used and if the accessories are needed. See below to identify the symbols:

	Enamel Tray
	Micro Power
	Oven

	Grill
	Frozen/ Turbo Defrost Mark

Notes:

1. This programs must only be used for foods described.
2. Only cook foods within the weight ranges described.
3. Always weigh the food rather than relying on the package weight information.
4. The temperature for frozen food is assumed to be -18 °C to -20 °C. The temperature of chilled food is assumed to be +5 °C to +8 °C (refrigerator temperature).
5. Always use the accessories as indicated.
6. Most foods benefit from a standing time after cooking on an auto program, to allow heat to continue conducting to the centre.
7. To allow for some variations that occur in food, check if food is thoroughly cooked and piping hot or not before serving it.
8. If ‘HOT’ appears in the display window, the oven temperature is too high from previous use and an auto program can not be set. Cooking mode and time may still be set manually.

Auto Cook Setting and Menus (continued)

English

Number	Menu	Serving/Weight				Recommended Containers	Accessories and Placement
1	Double Boil	4-6 (serves)	1-3 (serves)	-	-	Casserole with lid	-
2	Quick Soup	4-6 (serves)	1-3 (serves)	-	-	Casserole with lid	-
3	Vegetables	100 g	200 g	300 g	400 g	Casserole with lid	-
4	Casserole Rice	150 g	300 g	450 g	-	Casserole with lid	-
5	Congee/Porridge	100 g	150 g	200 g	-	Casserole with lid	-
6	Instant Noodle	1 serv	2 serves	-	-	Casserole with lid	-
7	Stew	4-6 (serves)	1-3 (serves)	-	-	Casserole with lid	-
8	Reheat Chinese Bun (Pau)	100 g	200 g	300 g	-	Dish with wrap	-
9	Fish	100 g	200 g	300 g	400 g	Dish with wrap	-
10	Frozen Pizza	200 g	350 g	-	-	-	Enamel Tray on Lower shelf position
11	Frozen Potato Fries	200 g	300 g	400 g	-	-	Enamel Tray on Upper shelf position
12	Chicken Wings and Drumsticks	200 g	400 g	600 g	-	-	Enamel Tray on Lower shelf position
13	Roast Chicken	600 g	900 g	1200 g	-	-	Enamel Tray on Lower shelf position
14	Meat Skewers	200 g	300 g	400 g	-	-	Enamel Tray on Upper shelf position
15	Frozen Breaded Products	200 g	300 g	400 g	-	-	Enamel Tray on Upper shelf position
16	Cake	20 cm (8 inches)	-	-	-	8 Inches Cake Tin	Enamel Tray on Lower shelf position
17	Cream Puff	9 pcs	-	-	-	-	Enamel Tray on Lower shelf position
18	Cookies	16 pcs	-	-	-	-	Enamel Tray on Lower Shelves
19	Home Made Pizza	23 cm (9 inches)	-	-	-	-	Enamel Tray on Lower shelf position
20	Pudding	6 pcs	-	-	-	Metal pudding cups	Enamel Tray on Lower shelf position
F1	Cleaning Program	Cleaning Function					

Notes:

1. If the temperature of the cavity is too high, auto cook feature can not be used. Display window will appear "HOt". Auto Cook feature can be used until the "HOt" disappears.
2. Cook according to the following cooking method.

Auto Cook Setting and Menus (continued)

1. Double Boil

It is suitable for cooking traditional soups; herbal soup, birdnest soup, etc., that requires slow simmer or 'double boil'. This method ensures food remains tender without losing its shape. It also extracts and retains the aromatic flavour of the food. Place all ingredients and liquid in a high microwave safe and heat proof casserole dish. Allow at most ½ depth of volume for evaporation to prevent boiling over. Cook covered with a lid or microwave safe plastic wrap. Open the door to stir when two beeps heard during cooking, press **Start** pad to continue.

Measure water and ingredients as the below chart for reference.

Serving	Meat	Vegetables	Water
4-6 serves	500 g	400 g	1000 ml
1-3 serves	250 g	200 g	650 ml

2. Quick Soup

Suitable for cooking quick soups such as chicken soup, rib soup etc., clean all raw materials and ingredients for later use. Add all raw materials, ingredients and water into a microwave safe container with lid. Allow at most ½ depth of volume for evaporation to prevent boiling over. Open the oven door to stir when two beeps heard during cooking, press **Start** pad to continue. Add seasonings after cooking.

Measure water and ingredients as the below chart for reference.

Serving	Meat	Vegetables	Water
4-6 serves	300 g	850 g	1000 ml
1-3 serves	150 g	450 g	500 ml

3. Vegetables

Suitable for cooking different kinds of vegetables. Clean the vegetables and place them in a microwave safety container, add some oil and stir. Cover with the lid. Stir when two beeps heard during cooking. Add salt and other seasonings after cooking, then stir.

4. Casserole Rice

It is suitable for cooking plain rice. Always use a high microwave safe casserole and cover with a lid or microwave safe plastic wrap. When cover, always allow at most ½ depth of volume for evaporation to prevent boiling over. Open the oven door to stir when two beeps heard during cooking, press **Start** pad to continue. Allow rice to stand for 5-10 minutes after cooking. Measure rice and water as the below chart for reference.

Rice	150 g	300 g	450 g
Water	250 ml	500 ml	800 ml

5. Congee/Porridge

Use the containers suitable for microwave and the containers for microwave rice cooking are recommended. Soak the rice for about 30 minutes. The proportion between the water and rice is the same as the form below. The total volume should not be over half of the total container. Keep the vent of the container opening. If no vent or the vent is not large enough, do not close the container securely to prevent boiling. Open the microwave oven when hearing the two beeps, take the container out of the oven and stir carefully. Then do not cover the container securely and take it back the oven. Press **Start** pad to continue. Wait 5-10 minutes after cooking, then taste your porridge.

Note: Open the cover carefully after cooking to prevent scalding as the high temperature.

Measure rice and water as the below chart for reference.

Rice	100 g	150 g	200 g
Water	750 ml	1000 ml	1300 ml

6. Instant Noodle

Suitable for cooking different kinds of instant noodle. Put the noodle and seasonings into a microwave safe container, then pour water. The total volume of the food cannot be over half of the container. Please keep the vent opening when cooking, if no air vent or the vent is too small, the lid should not be covered securely to prevent boiling. For the 2 serves, please stir when hearing two beeps. After finished, let stand for 2 minutes. Measure water and ingredients as the below chart for reference.

Instant Noodle	1 serv (80 g)	2 serves (160 g)
Water	450 ml	800 ml

7. Stew

For cooking meat/poultry stews. Suitable for tougher cuts of meat/poultry. Place all ingredients and liquid in a high microwave safe and heat proof casserole. Allow at most ½ depth of volume for evaporation to prevent boiling over. Cook covered with a lid. Open the door to stir when two beeps heard during cooking, press **Start** pad to continue.

Measure water and ingredients as the below chart for reference.

Serving	Meat	Vegetables	Water
4-6 serves	1200 g	400 g	600 ml
1-3 serves	600 g	200 g	300 ml

Auto Cook Setting and Menus *(continued)*

8. Reheat Chinese Bun (Pau)

Suitable for reheat refrigerated Chinese buns, the weight is 50 g per piece. Arrange the buns into a microwave safe container intensively, spray some water, covered with plastic wrap. place the container at the center of the flat table, and select the program and weight, then start.

9. Fish

Suitable for cooking different kinds of fish (thickness of fish should not be more than 3 cm). Place the fish on the microwave safe dish, add salt, oil, onion and water for cook. Covered with wrap. Place the dish on the flat table. Select the program and weight, then start. Allow fish to stand for 2-3 minutes after cooking.

10. Frozen Pizza

Allow you to bake frozen pizza. Select the program and press **Start** pad to preheat the oven, after preheating, place pizza on the enamel tray on lower shelf position. Select the weight and press **Start** pad. Do not use plastic or lid.

Notes:

1. Set the cooking time manually according to the actual size when it does not conform to the size specified in the operation instruction.
2. No need to use aluminum foil or grease.

11. Frozen Potato Fries

To cook frozen thick potato fries. Select the program, then press **Start** pad to preheat the oven. Spread potato fries out onto enamel tray. After preheating, enter the weight of the frozen potato fries. Place enamel tray on upper shelf position. Select the weight and press **Start** pad. Open the door to stir when two beeps heard during cooking, then press **Start** pad to continue. For best results cook in a single layer.

Note: Potato fries vary considerably. We suggest checking a few minutes before the end of cooking to assess level of browning. This program is suitable for 10 mm ($\frac{3}{8}$ ") fries.

12. Chicken Wings and Drumsticks

To cook chicken wings and drumsticks. Clean the wings and drumsticks, marinated for one night. Select the program, press **Start** to preheat the oven. After preheating, place food on enamel tray with baking paper on it, then place on lower shelf position. Select the weight, then start. Turn over when hearing two beeps during cooking time.

13. Roast Chicken

Clean the chicken and cut open from the breast. Marinate it for about 1 hour with seasonings. Select program and press **Start** pad to preheat the oven, after preheating, place the chicken on the enamel tray on lower shelf position. Select the weight and press **Start** pad. Allow chicken to stand for 5 minutes after cooking.

14. Meat Skewers

Allow you to roast fresh meat skewer, chicken pieces. Marinate the food with seasoning for 1 hour. Select program and press **Start** pad to preheat the oven. After preheating, place the food on the enamel tray on upper shelf position. Select the weight and press **Start** pad. Turn over when hearing 2 beeps during cooking time. Do not use plastic or lid.

15. Frozen Breaded Products

To cook frozen breaded products such as frozen popcorn chicken, frozen chicken nuggets, frozen turkey drummers, frozen fish fingers, frozen scampi. Select the program, press **Start** to preheat the oven, after preheating, remove all packaging and place the frozen breaded products on the enamel tray on upper shelf position. Select the weight, then start. Turn over when hearing 2 beeps during cooking time.

Auto Cook Setting and Menus *(continued)*

16. Cake (Round 8" cake mold)

Ingredients:

Egg	200 g (about 4 pcs)
Self-raising flour	170 g
Castor sugar	170 g
Milk	1 tbsps
Butter	20 g

Method:

1. Beat eggs and castor sugar into a container and stir with an eggbeater at low speed until the sugar is dissolved completely. Adjust to high speed until the beaten eggs are completely foamed and the footprint of the eggbeater keeps for a while. Readjust to low speed to make the bubbles uniformly.
2. Select the program and press **Start** to preheat.
3. Gradually add the sifted flour into the mixture. Mix them with a wooden spoon from bottom to top. Add the melt butter and milk into the mixture and stir evenly. Cover the baking paper at the bottom and edges of the mold and pour in the mixture. Put the mold on the enamel tray. After preheating, the oven will beep. Put the enamel tray on the lower shelf position quickly and press **Start** pad.

Notes:

1. The mixing method will affect the cooking result directly. After adding the flour, do not mix excessively.
2. Put the enamel tray on the lower shelf position quickly at the completion of preheating. If the door is opened too long, it can affect the cooking result.
3. Insert a toothpick in the center. Cake is cooked if the toothpick comes out clean.

17. Cream Puff

Ingredients:

Plain flour	50 g
Butter	50 g
Egg	150 g (about 2-3 pcs)
Water	80 ml

Method:

1. Heat the butter and water to boiling on gas. Pour the flour into the mixture quickly and stir continually till the mixture is transparent. Switch off the gas. Gradually add the beaten eggs into the mixture, whisk continually till the mixture begins to sticker and the mixture dropped stringy by using wooden spoon, then stop to add beaten eggs.
2. Select the program and press **Start** to preheat.
3. Place the aluminum foil on the enamel tray and grease. Cut the mixture to 25 g each and arrange into 3x3 shape equidistantly. After preheating, the oven will beep. Place the enamel tray on the lower shelf position quickly and press **Start** pad.

Notes:

1. Whisk quickly and evenly when gradually adding the beaten eggs.
2. Do not add excessive eggs when the mixture begins to string.
3. Arrange the puff equidistantly within 9 units to ensure cooking result.
4. Put the enamel tray on the lower shelf position quickly at the completion of preheating. If the door is opened too long, it can affect the cooking result.
5. After cooking, take out the enamel tray carefully with mitten, separate the puff from the foil and place it in another dish, if not, after the puff cooling down, it is hard to separate them down.
6. Fill the cream as desired.

18. Cookies

Ingredients:

Egg	25 g
Plain flour	90 g
Butter	50 g (room temperature)
Castor sugar	40 g

Method:

Whisk the butter and sugar to be softened and creamy with egg beater. Add beaten eggs and stir evenly. Gradually add sifted plain flour and stir evenly with wooden spoon. Refrigerate for 2 hours. Place the aluminum foil on the enamel tray. Cut the mixture to cookie shape with 7-8 mm height and 12 g each and arrange into 4x4. Select the program and press **Start** pad to preheat. After preheating, the oven will beep. Put the enamel tray on the lower shelf position quickly and press **Start** pad.

Notes:

1. Ensure the butter to be soft under room temperature in advance.
2. Put the ingredients in a deep container to avoid splash when whisking.
3. Arrange the cookies equidistantly and under specified volume for a better performance.
4. After preheating, place the enamel tray on the lower shelf position immediately. If the door is opened too long, it will affect the cooking result.

19. Home Made Pizza

Ingredients:

Dough:

- Plain flour (sieved) 130 g
- Salt 3 g
- Instant yeast 4 g
- Sugar 10 g
- Milk powder 7 g
- Butter 10 g
(room temperature)
- Lukewarm water 65 ml

Pizza Sauce:

- Tomato puree 45 g

Pizza Toppings:

- Sausage (sliced) 70 g
- Mushroom (sliced) 30 g
- Onion (chopped) 50 g
- Mozzarella cheese 100 g
(shredded)
- Tomato (sliced) 1
- Green pepper 50 g
(sliced)
- A dash of paprika

Method:

1. Place flour, salt, yeast, sugar, milk powder and butter in a mixing bowl.
2. Partially add lukewarm water into flour mixture and knead it till it forms soft dough.
3. Place dough into a mixing bowl, cover with wrap and pierce holes on the wrap.
4. Place dough in oven, set to 40 °C to ferment for 1 hour. (till dough doubles in size)
5. Flatten the fermented dough out on the table coated with a layer of flour, and compact as much as possible to ensure there are no air pockets. Roll out dough into 23 cm diameter and place it on greased enamel tray. Top with tomato sauce and filling then apply mozzarella cheese over the whole surface.
6. Select the program and press **Start** pad. The oven will begin to preheat.
7. After preheating, the oven will beep. Quickly place the enamel tray into the lower shelf position. Press **Start** pad. The oven will begin to work.

20. Pudding (metal pudding cup with 6 cm diameter and 5 cm depth)

Ingredients:

- Sugar 100 g
- Milk 400 g
- Egg yolk 5 pcs
(stirred uniformly)
- Warm water (50 °C) 400 ml

Method:

1. To prepare caramel: Add a large spoon of water into 40 g sugar, pour water and sugar into a container to heat for 3 minutes 15 seconds at medium power. Stir at the half time. Take the sugar out when it turns to dark brown. Add a large spoon of water, quickly stir and left stand for cooling down.
2. To prepare egg liquid: Add 400 g milk and 60 g sugar into a container to heat for 3 minutes 30 seconds at med-high power to make sugar completely dissolve into the milk (about 65-75 °C). Then add egg yolk and stir the mixture uniformly. Coat the inside of the mold with butter, spread 3 g of caramel at the bottom uniformly, and add 80 g egg liquid (about 40-50 °C). Wrap the mould mouth with foil. The total volume cannot exceed $\frac{3}{4}$ of the mold.
3. Select the program and press **Start** pad. The oven will begin to preheat.
4. Lay a piece of kitchen paper onto the enamel tray and pour 400 ml of 50 °C warm water. Arrange the pudding molds in a shape of 3x2 onto the enamel tray as shown below.
5. After preheating, the oven will beep. Place the enamel tray into the lower shelf position quickly. Press **Start** pad. The oven will begin to work.
6. After the pudding has cooled, put it in the refrigerator for 2 hours before serving.

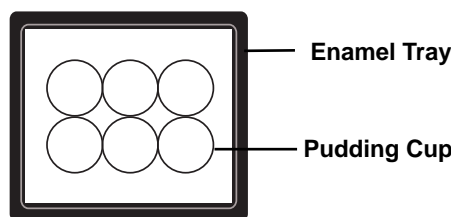

Defrosting Chart

Preparation for Freezing:

1. Heavy-duty plastic wraps, bags and freezer wrap are suitable.
2. Freeze meats, poultry and fish in packages with only 1 or 2 layers of food. To aid in separating layers, place two pieces of wax paper between them.
3. REMOVE ALL AIR and seal securely.
4. LABEL package with tape and cut of meat, date and weight.
5. Defrosting times given in the charts are for thoroughly frozen foods (i.e. at least 24 hours in freezer maintained at -18 °C or lower).

Defrosting Technique:

1. Remove from wrapper and set on a defrosting rack in a dish on flat table.
2. On Turbo Defrost, the oven will beep during the defrosting time. At "beep", turn over all meat, poultry, fish and shellfish. Break apart stewing meat, chicken pieces and minced meat. Separate chops and hamburger patties. Shield thin ends of roasts, poultry legs and wings, fat or bones with foil.
3. Throughout the defrosting time, remove any defrosted portions of mince or cubed meat, etc.
4. After defrosting, large roasts may still be icy in the centre. Let stand, 15 to 30 minutes, in refrigerator to complete defrosting.

Defrosting Chart (by setting Micro Power at 270 W):

FOOD	APPROX. TIME (minutes per 500 g)	INSTRUCTION
Meat		
Beef		
Minced Beef	6 - 8	Halfway through the defrost cycle, break apart minced beef, separate chops and remove meat that is defrosted.
Roast: Topside	7 - 9	
Roast: Beef Tenderloin	7 - 9	
Roast: Chuck or Rump	6 - 8	
Roast: Sirloin, rolled	7 - 9	Turn meat over two to three times during defrosting.
Steak	6 - 7	Shield edges and unevenly shaped ends of roasts halfway through the defrost cycle.
Miscellaneous	6 - 8	
Lamb		
Roast	6 - 8	Large roasts may still be icy in centre. Let stand.
Chops	5 - 7	
Ribs	5 - 7	
Poultry		
Chicken/whole	7 - 9	Turn poultry over two to four times during defrosting. Halfway through the defrost cycle, shield end of drumsticks, wings, breast bones and ends of poultry with foil.
Chicken/pieces	6 - 8	
Chicken/fillets	6 - 8	Break apart chicken pieces and remove small pieces such as wings, which may be defrosted before larger pieces.
Duck	6 - 8	
Turkey	7 - 9	Rinse poultry under cold water to remove ice crystals. Let stand 5 to 10 minutes, before cooking.
Fish & shellfish		
Fish Fillets	6 - 8	Halfway through the defrost cycle, turn whole fish or blocks of fillets over. Also, break apart prawns or scallops. Remove any pieces that are defrosted.
Whole Fish	6 - 8	
Crabmeat	5 - 7	
Lobster Tails	5 - 7	Let stand, 5 to 10 minutes, before cooking.
Sea Scallops	4 - 6	
Green Prawns	5 - 7	

Reheating Charts

The times given in the charts below are a guideline only, and will vary depending on STARTING temperature, dish size and quantity.

Food	Weight/ Quantity	Power Level	Cooking Time (approx.)	Instructions
Chilled meal	200 g	1000 W	2 mins - 2 mins 30 secs	Place in a microwave safe and heat- proof dish on base of oven.
Frozen meal	200 g	1000 W	3 mins 30 secs - 4 mins	Place in a microwave safe and heat- proof dish on base of oven.
Sandwich	100 g	1000 W	30 secs	Place in a microwave safe and heat- proof dish on base of oven.
Canned soup	600 ml	1000 W	3-4 mins	Place in a microwave safe and heat-proof dish with cover on base of oven. Stir half way and end of cooking.
Beverage	235 ml	1000 W	1 min 30 secs	Place in a microwave safe cup on base of oven. Stir half way and end of cooking.
Milk	250 ml	1000 W	1 min - 1 min 30 secs	Place in a microwave safe cup on base of oven. Stir half way and end of cooking.
Canned vegetables				
Bean	415 g	1000 W	2 mins 30 secs - 3 mins	Place in a microwave safe and heat- proof bowl with cover. Place on base and stir halfway.
Tomato	400 g	1000 W	2 mins - 3 mins	
Mushrooms	290 g	1000 W	2 mins - 2 mins 30 secs	
Sweetcorn	330 g	1000 W	2 mins - 2 mins 30 secs	
Meat pies	150 g	1000 W	1 min 30 secs- 2 mins	Place in a microwave safe and heat- proof bowl on base.

English

Cooking Charts

English

Food	Weight/ Quantity	Power Level	Time to Select (approx.)	Instructions
Meat				
Lamb joint	Maximum weight 1.5 kg	180 °C	20 mins per 500 g plus 25-30 mins	Preheat the oven. Cook on Enamel Tray in lower shelf position. Turn halfway. Wrap in foil and allow to stand for 10 mins after cooking.
Steak -medium	150 g	Grill 1	7-8 mins	Place on Enamel Tray in upper shelf position. Turn halfway
Steak -well done			9-10 mins	
Beef joint -well done	Maximum weight 1.5 kg	200 °C	20 mins per 500 g plus 30-35 mins	Preheat oven. Place on Enamel Tray in lower shelf position. Turn halfway.
Fish and Shellfish				
Fresh fish fillets	500 g	600 W	5-7 mins	Place in a microwave safe and heat-proof dish with cover on base of oven.
Frozen fish fillets	500 g	1000 W	9-10 mins	
Prawns	500 g	600 W	5-7 mins	
Mussels	500 g	600 W	5-7 mins	
Poultry				
Chicken legs	1.0 kg	200 °C	35-40 mins	Preheat the oven. Place chicken legs on Enamel Tray in lower shelf position. Turn halfway.
Whole chicken	per 500 g	190 °C	30-35 mins	Preheat the oven. Place chicken on Enamel Tray in lower shelf position. Turn halfway.
Fresh vegetable				
Asparagus	200 g	1000 W	5-6 mins	Add 1 tbsp water per 100 g. Place in a microwave safe and heat-proof dish with cover on base of oven.
Broccoli	250 g	1000 W	3-4 mins	
Peas	200 g	1000 W	4-5 mins	
Boiled potatoes	500 g	1000 W	14-15 mins	
Rice				
Long grain white	250 g	1000 W	11-13 mins	Use a 5 L microwave safe container. Add 550 ml boiling water. Cover partly and stir halfway.
Pasta				
Fusilli	200 g	1000 W	10 mins	Use a 5 L microwave safe container. Add 550 ml boiling water and 15 ml oil. Cover partly and stir halfway.
Spaghetti	250 g	1000 W	8-10 mins	

Before Requesting Service

ALL THESE THINGS ARE NORMAL:

The oven causes interference with my TV.	Some radio, TV, Wi-Fi, cordless telephone, baby monitor, Bluetooth or other wireless equipment interference might occur when you cook with the microwave oven. This interference is similar to the interference caused by small appliances such as mixers, vacuums, blow dryers, etc. It does not indicate a problem with your oven.
Steam accumulates on the oven door and warm air comes from the oven vents.	During cooking, steam and warm air are given off from the food. Most of the steam and warm air are removed from the oven by the air which circulates in the oven cavity. However, some steam will condense on cooler surfaces such as inside and/or on the oven door. This is normal and safe. Steam will disappear after the oven is cooled down.
I accidentally operate my microwave oven without any food in it.	Operating the oven empty for a short time will not damage the oven. However, we do not recommend this to be done.
The oven has an odour and generates smoke when using Oven and Grill function.	It is essential that your oven is wiped out regularly particularly after cooking by Oven or Grill. Any fat and grease that builds up on the roof and walls of the oven will begin to smoke if not cleaned.
Some smoke will be given off from the cavity when using Oven or Grill for the first time.	It caused by the excessive oil in the cavity and oil used for rust protection volatilizing.
The sound of "Bar... Bar..." may be emitted at the back of the oven cavity during and after the use of different kinds of Oven function.	This is a cause of thermal expansion and contraction of the metal material used in the product. It is normal.
Steam leaks out from all four sides of the oven door.	When a function related to steam is used, a lot of steam are generated in the oven cavity during operation of the product. Some steam may leak from all four sides of the oven door. It is normal.
The fan motor continues operating after cooking is over.	After using the oven, the fan motor will operate for several minutes to cool the oven and electric components. It is normal.

English

Before Requesting Service

(continued)

English

PROBLEM	POSSIBLE CAUSE	REMEDY
Oven will not turn on.	The oven is not plugged in securely.	Remove plug from outlet, wait 10 seconds and re-insert.
	Circuit Breaker or fuse is tripped or blown.	Contact the specified service center.
	There is a problem with the outlet.	Plug another appliance into the outlet to check if the outlet is working.
Oven will not start cooking.	The door is not closed completely.	Close the oven door securely.
	Start/Set pad was not touched after programming.	Press Start/Set pad.
	Another program has already been entered into the oven.	Press Stop/Cancel pad to cancel the previous program and program again.
	The program has not been entered correctly.	Program again according to the Operating Instructions.
	Stop/Cancel pad has been touched accidentally.	Program oven again.
"HOT" appears in the display window.	The cavity is overheated.	Operate again after it cools down.
The "🔒" appears in the display window.	The Child Lock was activated by tapping Start/Set pad 3 times.	Deactivate Lock by tapping Stop/Cancel pad 3 times.
"H97", "H98" appears in the display window.	This display indicates a problem with the microwave generation system.	Contact the authorised service center.
"d" appears in the display window.	The oven is under demonstration mode.	Press Micro Power pad once, Start/Set pad 4 times and Stop/Cancel pad 4 times.

If it seems there is a problem with the oven, contact an authorized Service Center.

Care of your Microwave Oven

Turn the oven off and remove the power plug from the wall socket before cleaning.

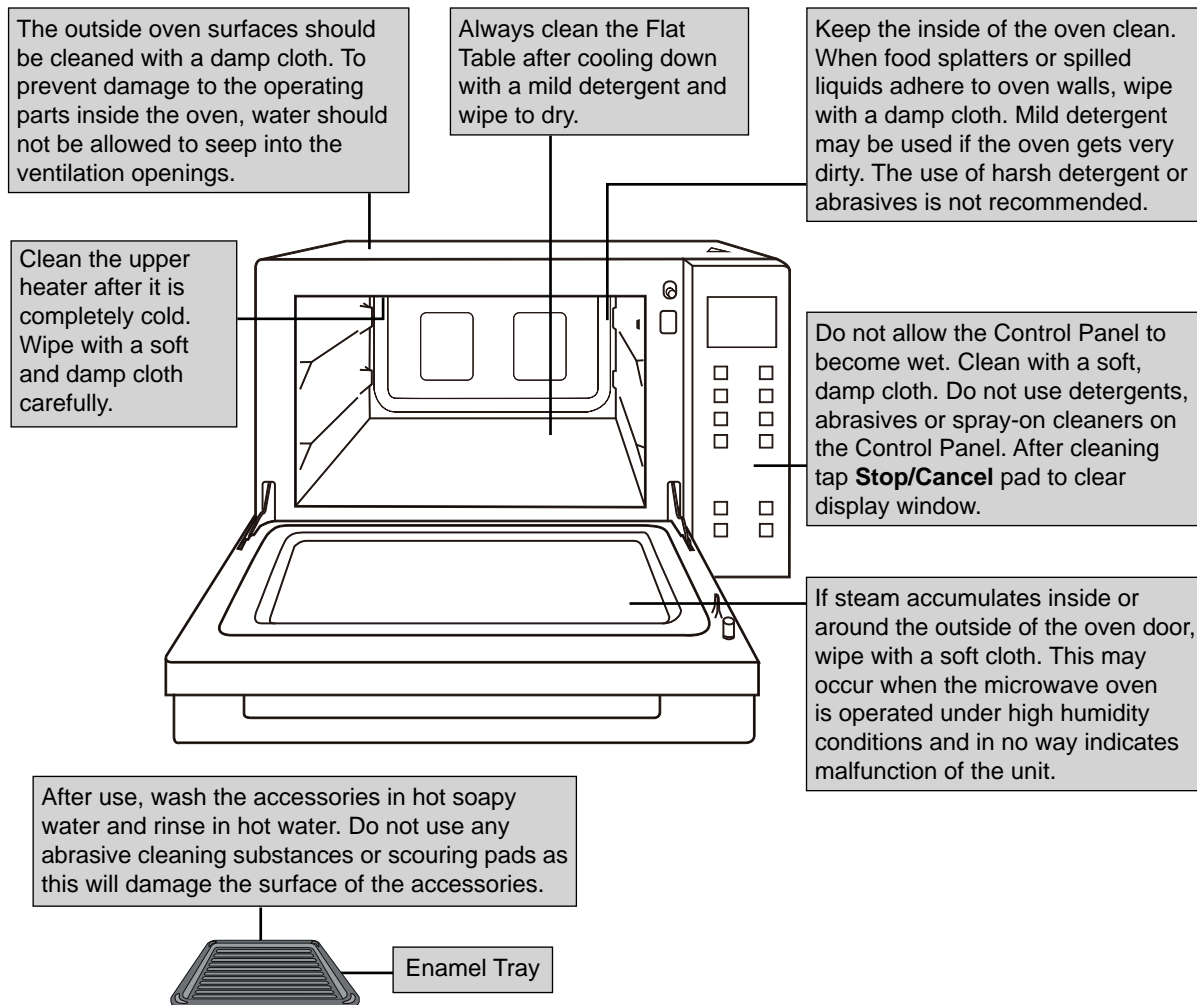

English

Notes:

1. When using the **Grill** or **Oven** mode, some foods may inevitably splatter grease on to the oven walls. If the oven is not cleaned, occasionally it may start to "smoke" during use. These marks will be more difficult to clean later.
2. After **Grill** or **Oven** cooking the ceiling and walls of the oven should be cleaned with a soft cloth squeezed in soapy water. Particular care should be taken to keep the window area clean particularly after cooking by Grill, Oven. Stubborn spots inside the oven can be removed by using a small amount of microwave oven cleaner sprayed onto a soft damp cloth. Wipe onto problem spots, leave for recommended time and then wipe off. This method can not be used to clean the oven door.

DO NOT SPRAY DIRECTLY INSIDE THE OVEN.

Do not use harsh abrasive cleaners or sharp metal scrapers to clean the oven door glass, since they can scratch the surface, which may result in shattering of the glass. A steam cleaner is not to be used.

3. Failure to maintain the oven in a clean condition could lead to deterioration of the surface that could adversely affect the life of the appliance and possibly result in a hazardous situation.
4. When it becomes necessary to replace the oven light, please consult the service center specified by Panasonic.

Technical Specifications

English

Model:		NN-DF38PB	
Power Supply:		220 V, 50 Hz	230 - 240 V, 50 Hz
Power Consumption:	Microwave	4.3 A, 920 W	4.0 A, 920 W
	Grill	4.3 A, 930 W	4.0 A, 930 W
	Oven	6.4 A, 1380 W	5.7 A, 1380 W
Output Power:	Microwave*	1000 W	
	Grill	900 W	
	Oven	1350 W	
Outside Dimensions (W x H x D):		483 mm x 313 mm x 412 (456**) mm	
Oven Cavity Dimensions (W x H x D):		315 mm x 220 mm x 350 mm	
Overall Cavity Volume:		23 L	
Operating Frequency:		2450 MHz	
Uncrated Weight (approx.):		12.2 kg	

Weight and Dimensions shown are approximate.

** 456 mm is the dimension with handle.

412 mm is the dimension without handle.

* IEC Test Procedure

Specifications subject to change without notice.

As for the voltage requirement, manufactory and serial number, please refer to the name plate on the microwave oven.