

## 5.1.2 CS-Z18ZKA CS-Z24ZKA

<Top View>

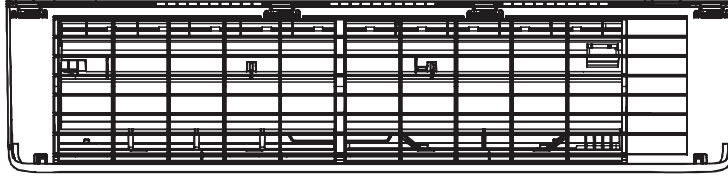

<Side View>

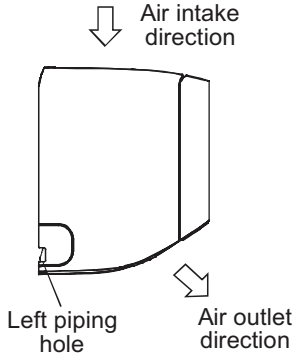

<Front View>

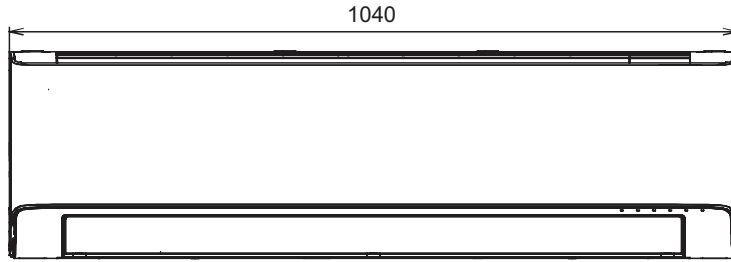

<Side View>

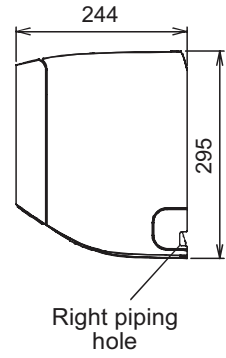

<Bottom View>

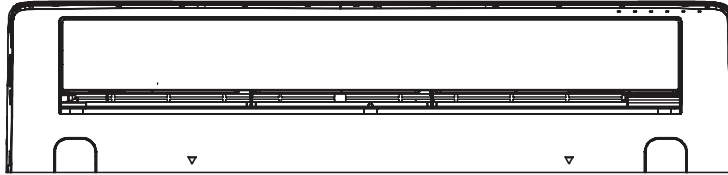

<Remote Control>

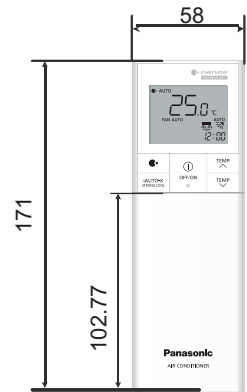

<Rear View>

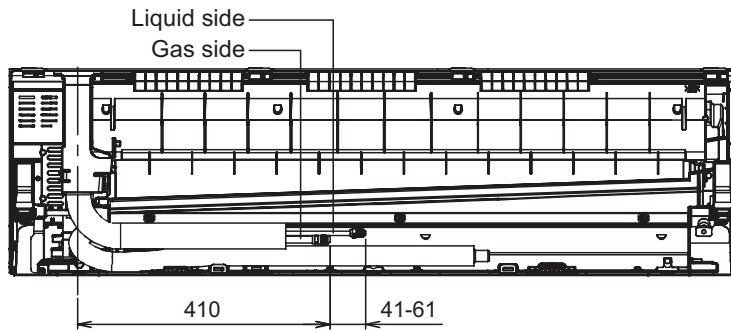

<Remote Control Holder>

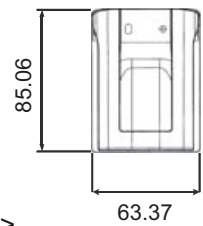

Relative position between the indoor unit and the installation plate <Front View>

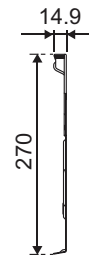
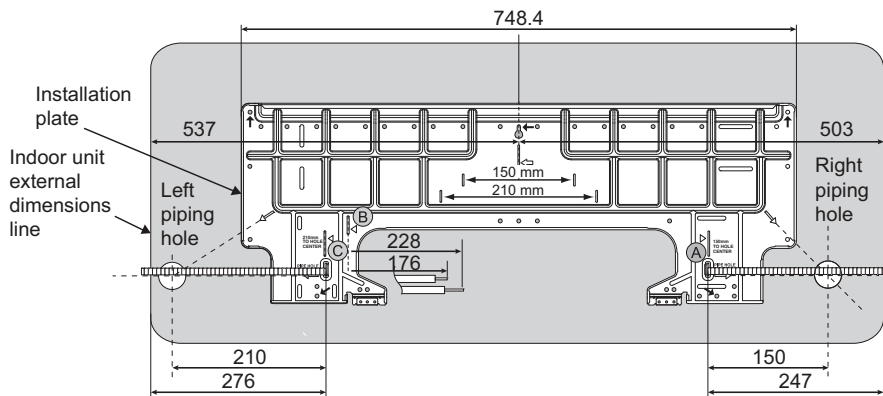

Unit: mm

### 5.2.3 CU-Z24ZKA

