

Panasonic®



Operating Instructions Refrigerator (Household use)

Manual Penggunaan Peti sejuk (Untuk kegunaan rumah)

使用說明書 雪櫃 (家用)

English



Model No.
No. Model
型號

NR-F654GT-X6
NR-F654HX-X3
NR-F603GT-X6
NR-F603GT-W6
NR-F603GT-N6
NR-F603GT-XP
NR-F603GT-XU
NR-F603GT-WU
NR-F503GT-X6
NR-F503GT-W6
NR-F503GT-T6
NR-F503GT-T7
NR-F603HX-X3
NR-F603HX-W3
NR-F603HX-N3
NR-F503HX-X3
NR-F503HX-W3
NR-F503HX-N3

Thank you for purchasing this Panasonic product.
Please read these instructions carefully before using this product.
Please keep this manual for future reference.
Photos and illustrations of NR-F603GT are used for explanation
in this manual.
Other models can be used in the same way.

Terima kasih kerana membeli produk Panasonic.
Sila baca arahan dengan teliti sebelum menggunakan produk ini.
Sila simpan manual ini untuk rujukan.

感謝您購買 Panasonic 的產品。
在使用本產品前，請仔細閱讀本說明書。
請妥善保存本手冊以備將來參考。
NR-F603GT 的相片和插圖用於本手冊中的說明。
其他型號也可以採用相同的方式。

ECONAVI

INVERTER

nanoeX™

Contents

Introduction	Safety instructions	3
Installation	Installation	6
	Choosing the right location.....	6
Operation	To use all features	7
	Temperature setting and a guide of temperature	7
	Control panel.....	8
	How to operate.....	8
	ECONAVI Operation.....	9
	nanoe™ X Operation.....	9
	Refrigerator compartment	10
	Prime Fresh/Chilled select room	12
	Fresh Freezing compartment	13
	Ice compartment.....	14
	Freezer compartment.....	16
	Vegetable compartment	16
Appendix	Cleaning, removing and re-installing	17
	Cleaning	17
	Setting to suit your preferences	20
	Troubleshooting	22
	In these cases?	25
	If the following sounds or indications are generated	26
	Specifications	27
	Separately sold parts	27

- This appliance is intended to be used in household and similar applications such as
 - staff kitchen areas in shops, offices and other working environments;
 - farm houses and by clients in hotels, motels and other residential type environments;
 - bed and breakfast type environments;
 - catering and similar non-retail applications.

■ For saving energy

- Do not stuff food into the compartments.
That may interfere with the cold air flow. Provide sufficient space between foods.
- Open the door only when necessary.
Minimizing the number of times the door is opened/closed prevents cold air from escaping and reduces the amount of wasted electricity.
- Do not block the cold air outlet with food items.
If cold air does not spread into every corner of compartments, then the interior will not be sufficiently cooled and more electricity will be consumed.
- The cold air discharges from the outlet of the duct at the back.
- Store warm food and drinks after they are cooled.
Otherwise, they will not only raise the interior temperature, but also affect the freshness of other foods.

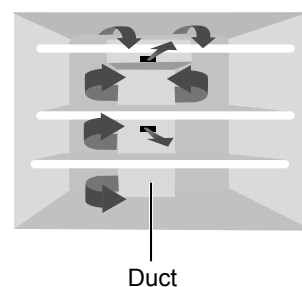

■ Disposing of the packaging

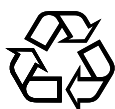





Please recycle where possible (e.g. cardboard, plastic bags, adhesive tape and polystyrene) and make sure you dispose of all other packing materials safely.

Keep the packaging out of reach of babies and young children to avoid injury or suffocation.

Safety instructions

What the symbols mean.

 Do not	 Make sure you do this	 Indicates the appliance must be earthed to prevent electric shock
 Do not take apart	 Warning; Risk of fire / flammable materials	



Indicates risk of death or serious injury.



- **WARNING:** Do not use mechanical devices or other means to accelerate the defrosting process, other than those recommended by the manufacturer.
- **WARNING:** Do not damage the refrigerant circuit.
(Otherwise, the flammable refrigerant may catch fire and lead to an explosion.)
- **WARNING:** Do not use electrical appliances inside the food storage compartments of the appliance, unless they are of the type recommended by the manufacturer.
(If the refrigerant leaks, it may catch fire due to sparks on the contacts.)
- Do not store explosive substances such as aerosol cans with a flammable propellant in this appliance.
- **WARNING:** Do not locate multiple portable socket-outlets or portable power supplies at the rear of the appliance.



- This appliance is not intended for use by persons (including children) with reduced physical, sensory or mental capabilities, or lack of experience and knowledge, unless they have been given supervision or instruction concerning use of the appliance by a person responsible for their safety. Children should be supervised to ensure that they do not play with the appliance.
- If the power cord or plug of the appliance is damaged, it must be replaced by the manufacturer or its service agent or similarly qualified person in order to avoid a hazard.
- **WARNING:** Fill with potable water only.
- **WARNING:** Keep ventilation openings, in the appliance enclosure or in the built-in structure, clear of obstruction.
- **WARNING:** When positioning the appliance, ensure the supply cord is not trapped or damaged.

For power plugs and cords...



- Do not use extension cords.
- Do not insert or disconnect the power plug into/from the wall socket with wet hands.
- Do not damage the power plug or cord. Do not cut or process the plug or cord; do not expose them to high temperatures; do not excessively bend, twist or pull them; do not place heavy objects onto them; and do not arrange them in bunches.
→ Contact your dealer for repairing the plug or cord.
- Do not push the rear of the refrigerator against the power plug.
- Do not use while the cord or power plug is damaged, or while the plug is not fully inserted into the outlet.



- Periodically remove dirt such as dust from the power plug.
- Plug into a wall outlet of the rated voltage on its own with the rated current and insert plug fully.
- When disconnecting the power plug, hold the plug itself not the cord.
- Disconnect the plug when cleaning the refrigerator.
- If you do not intend to use the refrigerator for an extended period of time, disconnect it.
(Otherwise, it may cause a fire or electrical shock.)

Stop using the refrigerator immediately and pull out the plug, if there is an abnormality or failure.

(Otherwise, it may cause smoke, a fire or electrical shock.)



Abnormality and failure examples

- Power cord or plug is abnormally hot
- Power cord is deeply cut or deformed
- There is a burning smell
- You can feel tingly electricity

Contact your dealer immediately for inspection and repair.

On top of the refrigerator...



- Do not put anything. Otherwise, it may fall due to vibration and cause injury.
- Do not put anything on the top cover. (Otherwise, parts may be deformed and may cause electrical shock.)

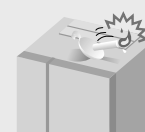

When using...



- Do not hang or ride on the door.
- Do not apply water on the body or interior. (Otherwise, electrical insulation deteriorates and may cause an electric shock or fire.)
- Do not touch the mechanisms above the ice-making tray.
- Do not remove the ice-making tray when the ice making function is operating.
- Do not store flammable items in the refrigerator.
- Do not store chemicals or scientific specimens.
- Do not spray combustible chemicals near the refrigerator.
- Do not add a high impact on glass doors. (Otherwise, glass may be broken and cause injury.)
→ If you find a crack, do not touch the glass and consult your dealer immediately.



- Children should be supervised to ensure that the refrigerator should be used properly.

When installing...



- Do not install the product in locations exposed to water.
- Do not fill the gaps around the refrigerator. (If the refrigerant leaks, it may catch fire.)



- Provide safety measures against overturning caused by such as earthquakes.



- Ensure that the refrigerator is plugged into an earthed mains socket. Do not plug into an unearthed mains socket. (3-pin plug)

When disposing and recycling the product...



- When a concern exists for possible entry of a child during recycling, remove the door packing.
- Flammable gas is used for refrigerant. And Cyclo-Pentane is used for insulation of this refrigerator. When you throw away this product, please dispose it by proper method.
- The warning labels mentioned above should be kept throughout the life of the refrigerator. This manual should be handed over to any person who would use or handle the refrigerator whenever the refrigerator would be transferred to another location or delivered to a recycling plant.

In case of emergency...

- Absolutely do not open the top cover and the back cover.
- Absolutely do not disassemble, repair or modify the refrigerator. (Otherwise, it may cause injury, burn, or electrical shock.)



- If you detect a gas (such as city gas) leak, do not touch the refrigerator and open the windows to ventilate the kitchen.
- A flammable refrigerant is used. If you have damaged the cooling circuit (piping), open the windows to ventilate the kitchen and contact your dealer.
- Maintenance work must only be carried out at workshop by well-trained maintenance worker. (Otherwise, it may cause an electrical shock, ignition or explosion.)

**Indicates risk of injury or damage to property.****When storing food...**

- Do not add a high impact on glass trays. (Otherwise, the glass trays may be broken and you may be injured.)
- Do not allow foods to protrude from the glass shelf.
- Do not store food containers on the door shelves if they do not reach the bottom of the shelves. (Otherwise, food may fall and cause an injury.)
- Do not freeze bottles. (If the liquid in a glass bottle is frozen, the bottle may be broken and you may be injured.)
- Do not touch frozen food or containers (especially metal), aluminum plate with wet hands. (Otherwise, you may get frostbite.)
- Do not eat food that has an unusual odor or is discolored. (Rotten food may cause illness.)

When opening/closing the doors...

- Do not open/close it if others come into contact with the refrigerator.
- Do not put your fingers in the gap on the side of the refrigerator compartment door when opening/closing the door.
- Do not open/close the ice compartment and the fresh freezing compartment with holding the top side of the drawer.
- Do not place your feet under the bottom drawer. (Otherwise, your toes may get caught.)
- Do not open or close the door with excessive force. (Otherwise, food may fall and cause an injury.)

**When cleaning...**

- Do not touch a metal rail directly.
- Do not place your hands or feet beneath the bottom of the refrigerator. (The edges of the metal panel may cause an injury.)



- Please be careful when you fit or remove a glass shelf. (Dropping glass shelves may cause shelf damage or an injury due to broken shelves.)

When moving or transporting the refrigerator...

- Fix the refrigerator with adjustable legs on the flat and stout floor. (Otherwise, the refrigerator moves or overturns and may cause an injury.)
- Apply protective covering, etc. to floors with a fragile surface.
- When transporting the refrigerator, hold the carrying handles and move with at least 2 people. (Otherwise, your hands may slip and cause an injury.)



Installation

Choosing the right location

1. Place the refrigerator in the following locations.

- Locations free from heat and direct sunlight
Minimize reduction of cooling power, and prevent electricity waste.
- Well-ventilated locations with low humidity
Minimize rust and generation of condensation.
- Stout and flat floor
With carpet, tatami mats or vinyl floors, deformation or discoloration may occur, so place a board underneath the refrigerator.
- Place the refrigerator away from other devices
Prevent noise and jammed image display on TVs and other devices.
- Locations where allow the power plug to be cleaned easily
Clean dust regularly.
(To prevent fire caused by dust.)
- Locations where allow a heat to dissipate
Place the refrigerator away from the wall (30mm or more) when vibration noise, discoloration of wall or dew condensation on the back surface bothers you.

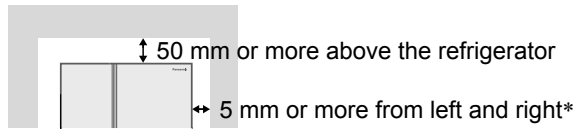

* In case of installing by the wall.
(Figure as viewed from above.)

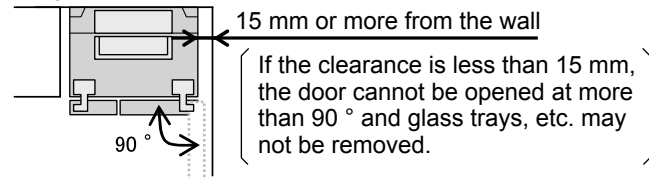

■ Before using the refrigerator for the first time. (P. 17 ~ P. 19)

- Wipe the inside of the refrigerator with a wet, soft cloth.
- Rinse the water supply tank, water purification filter and ice-making tray.

2. Fix the refrigerator.

- If the refrigerator has not been stabilized completely, you may hear rapping noises when the door is opened/closed. (This will not affect the performance.) Install the refrigerator on a stout and flat floor.
- Check whether the right and left doors of refrigerator compartment are parallel. If not, adjust the level of doors with the dedicated tool for adjustable legs.
- The refrigerator doors may be lowered due to the tilt angle of the installation site or the flooring used.
- At the time of purchase, the dedicated tool for adjusting the adjustable legs is attached to the leg cover. After use, you can store it in the back of the leg cover.

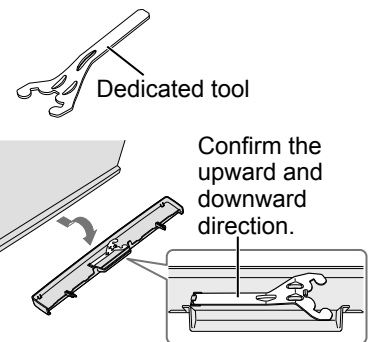

① Remove the leg cover.

Insert hands underneath the “▼” on both sides of the leg cover and pull it out.

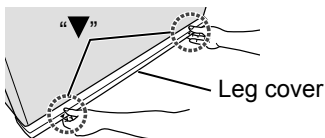

- #### ③ If a door has been lowered, turn the adjustable leg with the dedicated tool and adjust the level so that the doors become parallel.

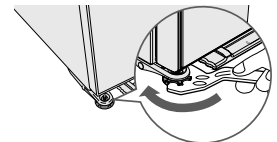

- #### ② Turn the adjustable legs (right and left) until they reach the floor to stabilize the refrigerator.

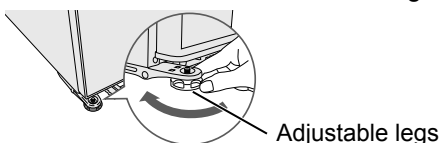

- #### ④ Reattach the leg cover.

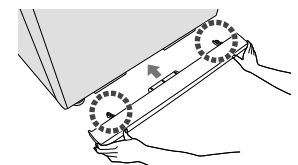

■ If the door is slanted downwards.

Turn the adjustable leg on the lower side, as shown in the illustration on the right, in order to adjust the level.

- The freezer/refrigerator doors may be slanted within 4 to 5 days after installation due to the load of the food or adaptation to the floor surface. In this case turn the adjustable legs again to restore.
- If it cannot be fixed by this method, use an adjustment plates. (Separately sold parts: P. 27)

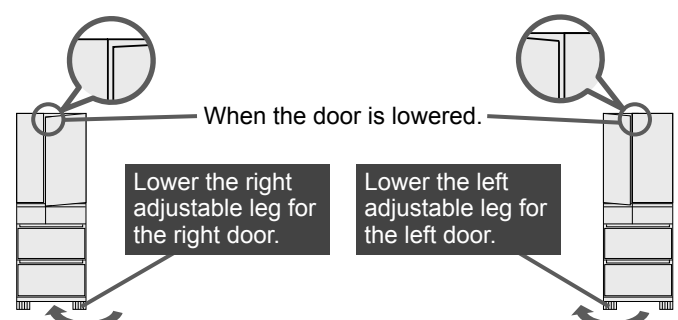

3. Plug into a wall outlet.

Plug into a wall outlet of the rated voltage on its own with the rated current and insert plug fully.

- The power plug can be plugged into an outlet immediately after installation.
- The surroundings and surfaces (side surfaces) of the refrigerator may become hot (approximately 50 °C to 60 °C when the ambient temperature is 30 °C) when the power is turned on, but this is not abnormal. (P. 23)
- If the power plug is removed, wait at least 7 minutes before plugging it back in. (P. 25)
- If there is no grounding wiring plug in refrigerator, it should be connected with grounding connection to prevent electrical hazard due to electric leakage.

For safety, the refrigerator should be grounded (For refrigerators with ungrounded 2-pin plugs)

A ground connection will prevent danger from electric shock.

A ground connection can be made in either of the 2 following ways:

1. When using a socket with a grounding receptacle, connect the ground wire to it and the screw for the ground connection on the rear of the refrigerator (please find the ⊕ symbol) as shown in illustration ①.
2. When using a socket without a grounding receptacle, connect the ground wire to the screw on the rear of the refrigerator (please find the ⊕ symbol), and then connect the other end to the ground rod as shown in illustration ②.

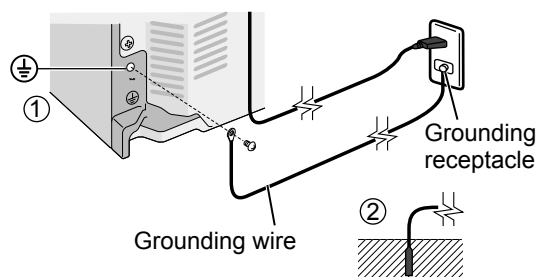

Ground connections must not be made with the following

- Gas pipes and water supply pipes (risk of electric shock or explosion)
- Ground wires of telephone cords and lightning rods (risk of lightning strike)

4. Cool the refrigerator interior.

- It may take approximately 4 hours to cool the interior.
- It may take 24 hours or more to cool the interior and achieve equilibrium in the summer, etc.
- Ice-making starts only after the interior has been cooled sufficiently.
- Do not open/close the doors until the interior has been cooled sufficiently. (Warm air flowing into the interior will block the cooling function.)

Requests

■ **Do not place objects on the top of the refrigerator.**

It may become hot due to heat generated by the compressor at the top of the refrigerator.

If it is difficult to release heat, the cooling capacity may be lowered.

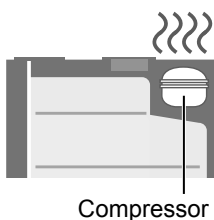

Notices

- Immediately after the installation, the noise becomes larger a little because the interior of the refrigerator is not cooled yet and the compressor or the fan is operated with high-speed rotation, but it is not abnormal. (Once the interior of the refrigerator is cooled, the noise becomes smaller.)

To use all features

Temperature setting and a guide of temperature



Temperature setting	CHILLED	1	2	3
FRIDGE		Approx. 2 °C ~ 3 °C higher than " 2 "	Approx. 3 °C ~ 6 °C	Approx. 2 °C ~ 3 °C lower than " 2 "
FREEZER		Approx. 2 °C ~ 3 °C higher than " 2 "	Approx. -20 °C ~ -18 °C	Approx. 2 °C ~ 3 °C lower than " 2 "
PRIME FRESH	Approx. 0 °C ~ 2 °C	Approx. 1 °C ~ 2 °C higher than " 2 "	Approx. -3 °C ~ -1 °C	Approx. 1 °C ~ 2 °C lower than " 2 "

(These are rough indications for when the ambient temperature is 32 °C, there is no food in the refrigerator and the interior temperatures have stabilized. The temperatures may differ depending on the ambient temperature, food storage state, door opening/closing and other usage conditions.)

To use all features

Control panel

Usually, the function setting section and the temperature setting section are not visible.

- Press  once to show the function setting section.
- Press  twice to show the temperature setting section.
- Press  3 times to hide the function and temperature setting sections.

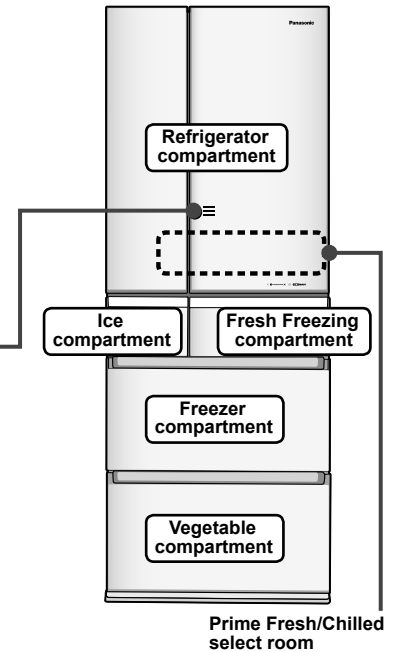
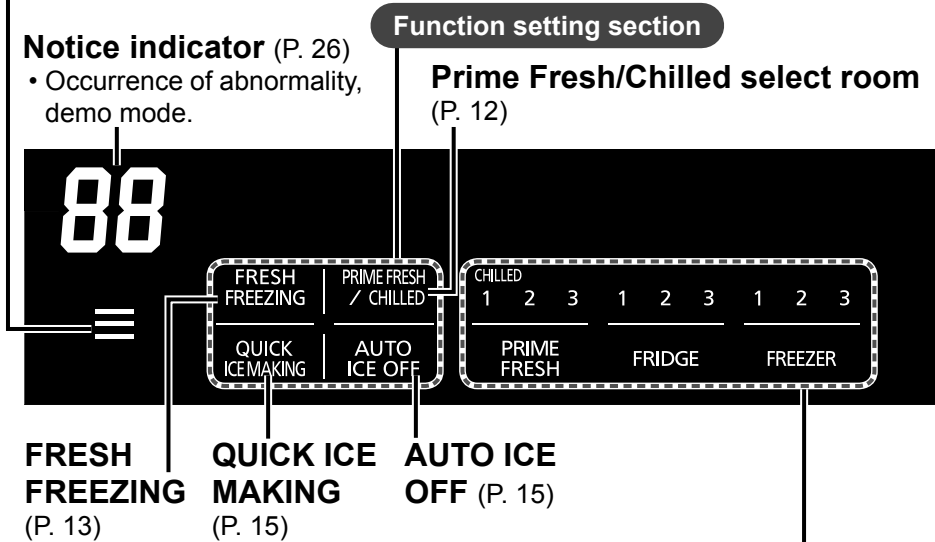





- Do not subject the control panel to a strong impact, or hit it with a hard object. (The surface may be cracked or scratched.)

- You can change the setting only when the doors of refrigerator compartment are closed.
- When "CL" appears in the notice indicator, operation lock function is activated. (P. 21)

How to operate (Example: To use the select room as the prime fresh room)

The select room is set to [CHILLED] at the time of purchase. Operate the control panel as follows.

■ To select temperature setting of [PRIME FRESH]

- Press .
 - The function setting section appears. (The indicator of function currently activated is lit.)
- Press .
 - The current status is lit. When **CHILLED** is displayed, **PRIME FRESH** does not operate.
- Press  again.
 - The display changes to **PRIME FRESH** "2". (The default setting is "2".)
- Press  to select your desired temperature setting "1", "2" or "3".
 - Each press of  switches to the next temperature setting and the indicator of selected temperature setting is lit.



When you finish operating, the function and temperature setting sections will disappear approximately 10 seconds later.

■ To adjust the temperature setting of refrigerator or freezer compartments.

- Press  twice to show the temperature setting section.
 - The indicator of temperature setting currently selected is lit.
- Press **FRIDGE** or **FREEZER** and adjust to your desired temperature setting.

ECONAVI Operation

■ 3 ECO functions detect the storage amount and the lifestyle.

Energy is effectively and automatically saved.*1

ECONAVI lamp is on during ECONAVI operation.

ECONAVI operates only when the temperature setting is “ 2 ” for both the freezer and refrigerator compartments.

Storage Eco

The storage sensors detect the change in the storage amount in the refrigerator compartment.

Smart Eco

3 weeks' worth of the number of door opening/ closing and the change in the storage amount for each day of the week and every hour are memorized, analyzed and estimated.

Night Eco

The light intensity sensor*2 detects the brightness of the room.

- The ON/OFF pattern of the lamp may change after 4th week in which what learnt starts functioning.
- The brightness of the lamp is lowered approximately 5 minutes after the lamp turns on. (The lamp can be turned off if it bothers you. P. 20)
- During detecting the change in the storage amount, ECONAVI lamp flashes slowly. (Approximately 15 seconds after closing the door of the refrigerator compartment.)
When the temperature setting of the refrigerator compartment and the freezer compartment is other than “ 2 ”, the lamp does not flash but the sensors are detecting the storage amount.
- ECONAVI operation may not be performed depending on the usage state of the refrigerator.

*1Effectiveness differs depending on the ambient temperature, ambient brightness, number of times of opening and closing of the doors and state in which food is stored.

*2The light intensity sensor operates at approx. 20 lux or below.

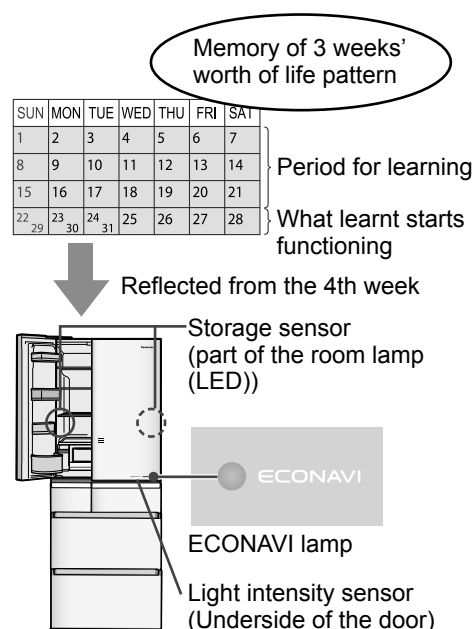

nanoe™ X Operation

■ A nanoe™ is a nano-sized ion particle coated with water particles.

nanoe™ X are nano-sized electrostatic atomized water particles with 10 times the OH radicals of nanoe™.

The operation mode of nanoe™ X is switched automatically regardless of temperature setting.

- The brightness of lamp can be adjusted. (P.21)

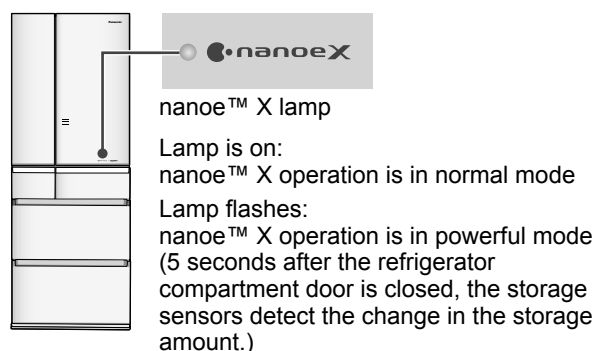

Notices

- The nanoe™ X emission outlet is on the ceiling side of the vegetable compartment.
- nanoe™ X is generated by gathering moisture in the air and the effect may change.
- nanoe™ X operation is switched to powerful mode automatically when the storage sensors detect that the storage amount is increased or full.

Refrigerator compartment

Approx. 3 °C ~ 6 °C

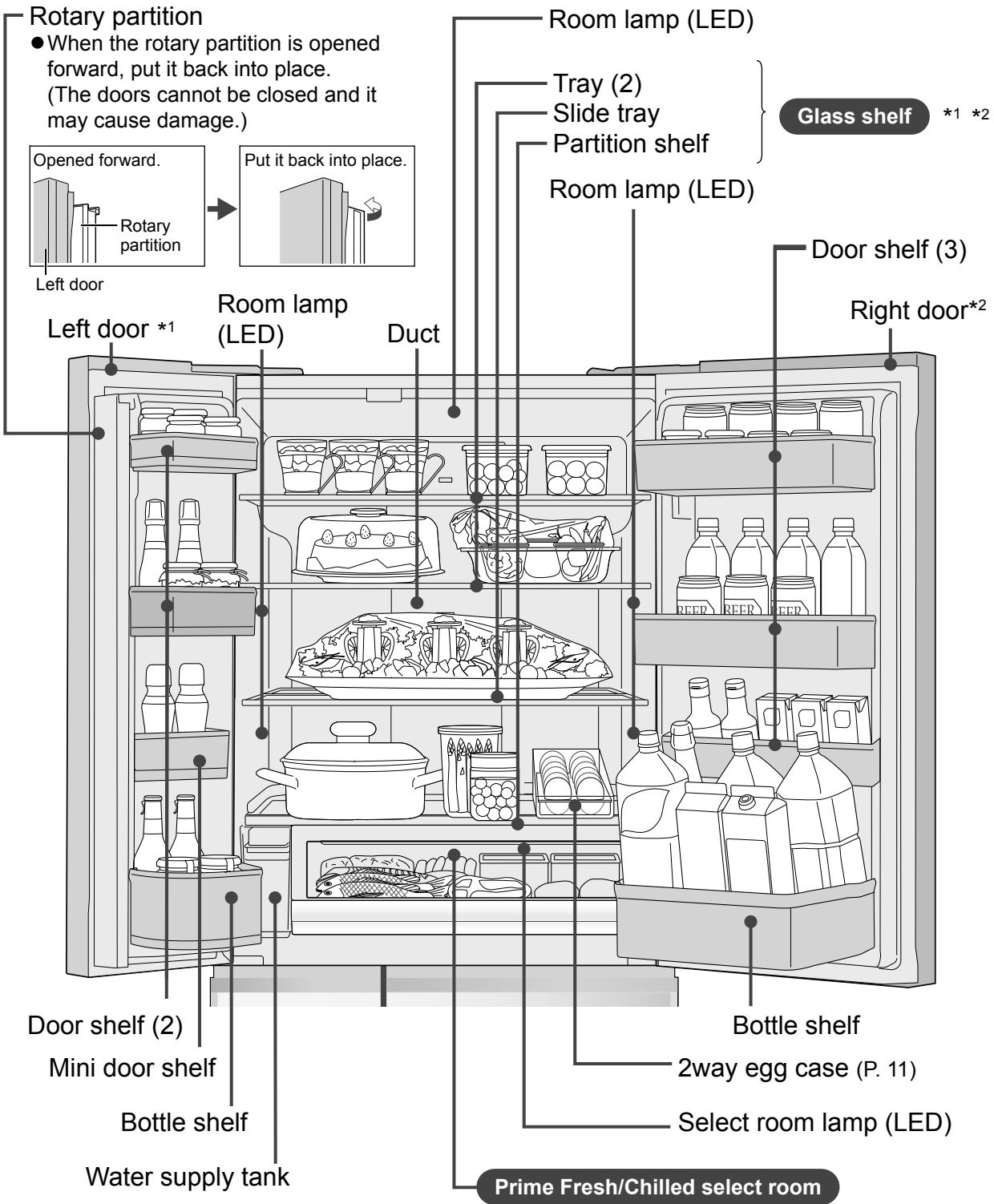

• Illustrations of NR-F603GT are used for explanation.

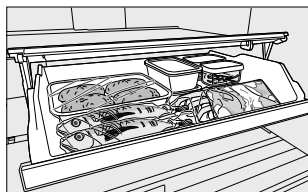

● Temperature zone can be chosen for [PRIME FRESH] or [CHILLED] to fit the type of food. (P. 12)

*1 The width of glass shelves and the left door of NR-F654GT/NR-F654HX is different from that of NR-F603GT.

*2 The width of glass shelves and the right door of NR-F503GT/NR-F503HX is different from that of NR-F603GT.

Slide tray (the third shelf from the top)

■ Slide the front part back, you can place taller items in front.

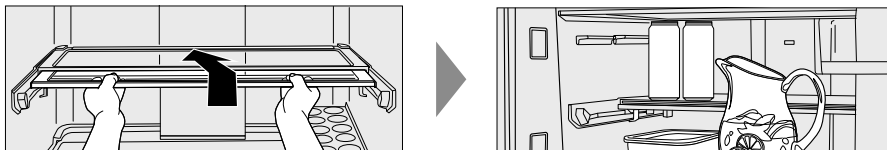

● You can easily place large pots.

Glass tray (only the second shelf from the top)

① Lift up the back of the tray and pull it forward. Once the protrusions of the tray are unhooked from the rails, tilt the tray and remove it.

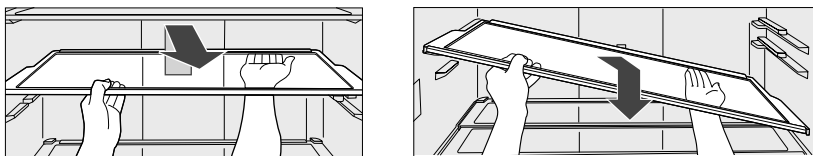

② Insert the tray in the desired position by reversing the steps.

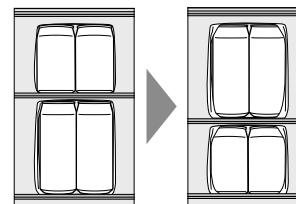

2way egg case

■ The egg tray can be set in 2 ways.

- When storing eggs, place them on the right side of the partition shelf. (Eggs may be frozen if they are placed in front of the air outlet.) (P.2)

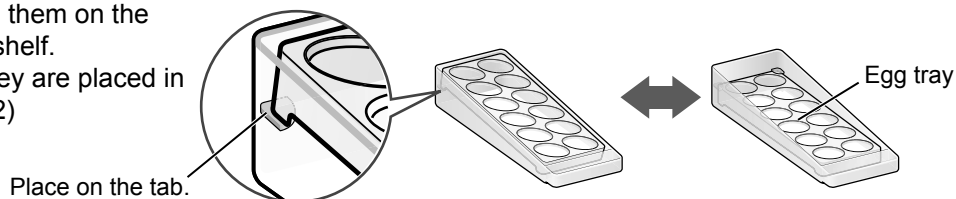

● Placing the egg tray inclined makes easier to take out eggs.

The “door shelves” can be moved.

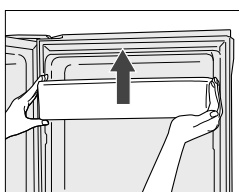

- ① While holding one end of the shelf with one hand, lightly tap the other end to raise it.
- ② Move the door shelf to your favorite position.

- For the right door, only the first shelf from the top.
- For the left door, only the second shelf from the top.

Requests

- If any food with a high water content is placed in front of the air outlet, it may be cooled excessively or frozen. (P. 2)
(There is a risk of burst especially when sodas are frozen.)

Put the following foods into an airtight container or wrap with plastic wrap.

- Green onions or other strong smelling vegetables. (→Odors will spread to other nearby food.)
- Cut citrus fruits. (→The plastic will be discolored white.)



Prime Fresh/Chilled select room

The select room is set to [CHILLED] at the time of purchase.
Please set to fit the intended purpose of food.

Using as the prime fresh room

Approx. -3 °C ~ -1 °C

■ When you want to extend the life of food by partially-freezing it.

- This room is suitable for storing fresh food such as meat or fish.
 - Compared to storing in the chilled room or the refrigerator compartment, the storage life of meat or fish becomes longer.
 - Temperature can be set to either “ 1 ”, “ 2 ” or “ 3 ” to fit the volume and type of food. (P. 8)
- The setting of PRIME FRESH “ 1 ”, “ 2 ” and “ 3 ” consumes 10% more energy than the setting of [CHILLED].

The select room lamp (LED) is lit in light blue

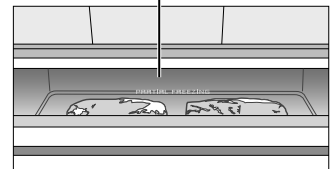

- When food is frozen too much.....
Sliced raw fish or sliced meat may be frozen too much. Set the temperature setting to “ 1 ” to prevent food from over frozen.
- When food is not partially-frozen.....
Depending on the type of food such as a block of meat or a large fish, the storage conditions and the ambient temperature, food may not be partially-frozen as it intended. Set the temperature setting to “ 3 ”.

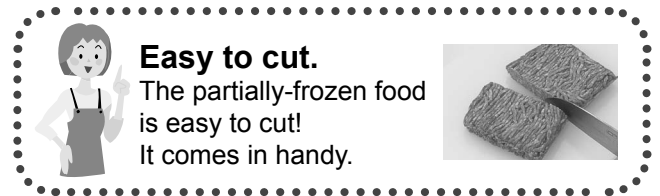

Using as the chilled room

Approx. 0 °C ~ 2 °C

■ When you do not want to freeze food.

- This room is suitable for storing chilled food or dairy products.
- Depending on food, it may be frozen partially.
Change the position of food or set the temperature setting of the refrigerator compartment to “ 1 ”.

The select room lamp (LED) is lit in white

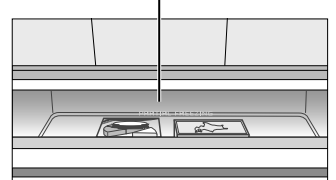

Tips for storing

■ Which is the suitable setting for these foods?

- Meat ● Fish



PRIME FRESH

- Chilled food
- Cheese
- Fresh cream
- Boiled noodle



CHILLED

■ What is the unsuitable food for the Prime Fresh/Chilled?

- Egg ● Milk ● Water ● Juice ● Tofu → In the refrigerator compartment

- Vegetable ● Fruit → In the vegetable compartment

- Ice ● Ice cream ● Frozen food → In the freezer compartment

Requests

- When you change the temperature setting, surely replace food to fit the set temperature.

Using "QUICK MODE"

When the temperature setting of the prime fresh/chilled select room is set to "1", "2" and "3", Prime Fresh Quick Mode is set and operated automatically.

■ While Prime Fresh Quick Mode is operated, cold air comes out more than usual and the time to freeze foods partially is reduced.

- When closing the flap of the case, the select room lamp (LED) is turned from light blue to blue, and Prime Fresh Quick Mode starts and automatically ends. (The select room lamp is turned to light blue after the completion of Prime Fresh Quick Mode.)
- Depending on usage state, Prime Fresh Quick Mode may start with a delay.
- It may take longer time to freeze foods partially depending on types of food, packing conditions, amount stored and the operating situation.
- When storing in the case, put your food within the height of the case. (Foods may fall in the back from the case and the flap may not be closed firmly and sensor detection may not work correctly.)
- While Prime Fresh Quick Mode is on, the sound becomes slightly louder and energy consumption increases more than usual.

During Prime Fresh Quick Mode the select room lamp (LED) is lit in blue

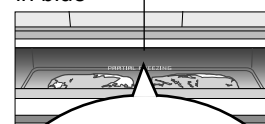

Wrap the food with plastic wrap or place the food in freezer storage packs. Do not stack them on top of each other.

In these cases, Prime Fresh Quick Mode time may become shorter or Prime Fresh Quick Mode may not start.

- When amount of food stored is small, or when refrigerator judges that Prime Fresh Quick Mode is not necessary because the temperature of food is low enough.
- Immediately after Prime Fresh Quick Mode ends. (to avoid that the food is cooled too much).
- During defrosting. •When "Fresh Freezing" or "Quick Ice Making" has been set.

Fresh Freezing compartment

Approx. -19 °C ~ -17 °C

Using "FRESH FREEZING"

■ Freeze ingredients or heated food such as hot rice instantly to keep the freshness of them.

① Press . The function setting section appears. (The indicator of function currently activated is lit.)



② Press to set Fresh Freezing function. When setting is completed,



turns on.

While Fresh Freezing is operated, is lit.

When Fresh Freezing is completed, turns off.

- Wrap the food with plastic wrap or place it in freezer storage packs, and put it on the aluminum plate.
- Fresh Freezing ends automatically after approximately 150 minutes.
- When you want to stop Fresh Freezing in the middle, do the same operation as described on the left.
- When food is stored for long periods after Fresh Freezing, store it in the freezer compartment.
- You can use as a freezer compartment when the Fresh Freezing does not operate.
- Store ice creams which contain much milk fat etc. in the freezer compartment.
- Do not put bottles or cans. (They may split or burst.)
- Do not put food that is taller than the case. (It will prevent the door from being closed properly, resulting in frost.)
- During Fresh Freezing, energy consumption increases more than usual.
- Prime Fresh Quick Mode or ECONAVI does not operate when Fresh Freezing has been set.

3 conditions of delicious Fresh Freezing

- ① Tightly wrap the food.
- ② Make the food closely contact with the aluminum plate.
- ③ Wrap hot food too.

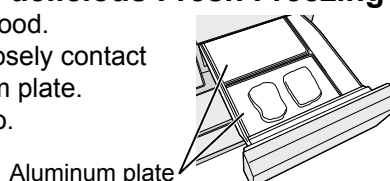

Ice compartment

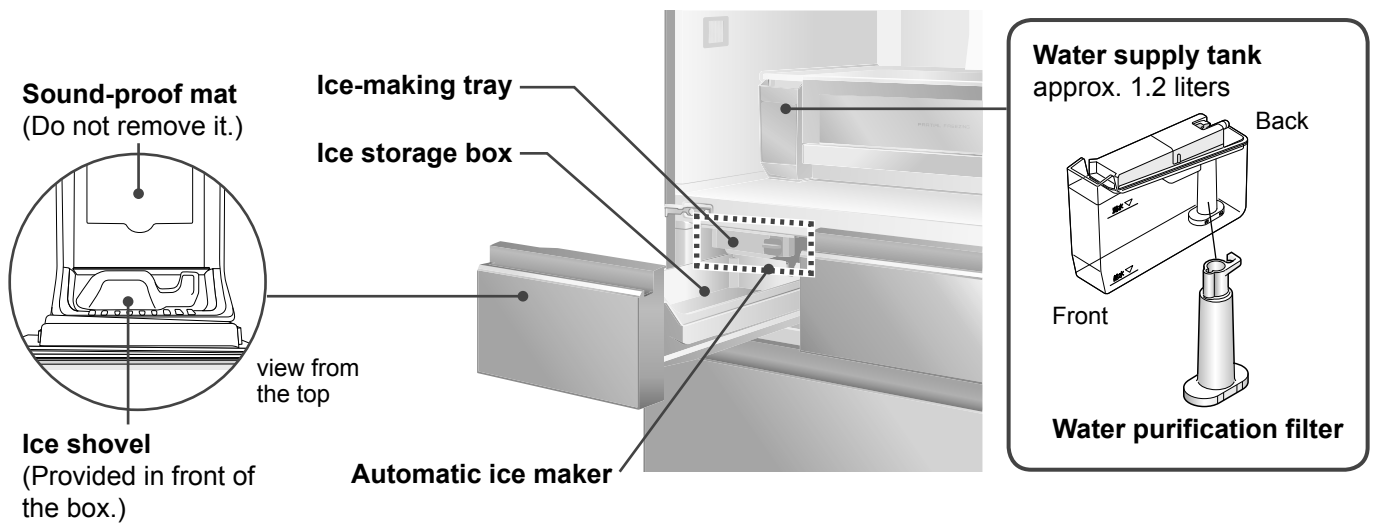

To use the automatic ice maker in comfort

Please use only the drinking water for auto ice making.

Clean the water supply tank and the ice-making tray with water frequently. (P. 19)

○ When the following water is used, wash the water supply tank frequently! (P. 19)

The hardness of water must be 100 mg/L or less.



Drinking water



Do not put liquids such as the following into the water supply tank.
(These may damage the ice compartment or cause ice cubes stick to each other.)



Juice, etc.



Sports drinks



Carbonated drinks



Hot water

Requests

- Do not slam the ice compartment door open/close.
(Ice may drop to the freezer compartment case or into other places.)
- Do not pour water directly into the ice-making tray to make ice.
(This may cause damage to the ice maker or ice cubes may stick together.)
- Do not pour water directly into the ice storage box to make ice.
(Otherwise, the ice storage box may be broken.)
- Hardness of water must be 100 mg/L or less.
The minerals may appear as white floating particles. They are not harmful.
- Do not put food or other items into the ice compartment.
(Otherwise, the amount of ice cannot be correctly detected and auto ice making may be stopped or the door cannot be opened.)
- When you use the ice compartment for the first time, odor or dust may be on the ice-making tray etc. Please throw away the first lot of ice.

Notices

Auto ice making operation stops automatically when the box is filled with ice cubes. (The operation does not work correctly in the following cases.)

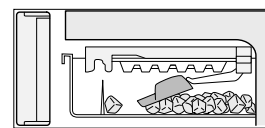

The ice shovel left in the ice storage box hits the ice detection lever.

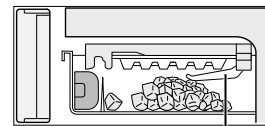

Ice cubes forming a mound hit the ice detection lever.

Ice detection lever
(When pressed, stops the auto ice making function.)

It will take longer to make ice in the following cases.

- When the refrigerator is used for the first time. (It may take 24 hours or more because the auto ice making function will start only after the interior has cooled sufficiently.)
- When the doors are opened frequently.
- When the door is ajar.
- When a large amount of food is stored at once.
- When the ambient temperature is low in winter, or it is high in summer.
- When a power failure occurs.
- When the washable ice-making tray has been cleaned. (P. 19)

To make ice

Ice can be made in approx. 2 hours!

① Take out the water supply tank.

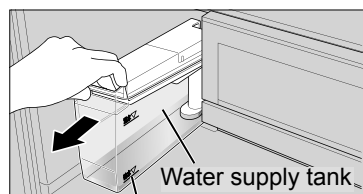

Add water if the level is below the “給水” line. (Replace the water in the water supply tank at least once a week.)

② Fill with water.

Do not add water over the line. Put the lid back tightly.

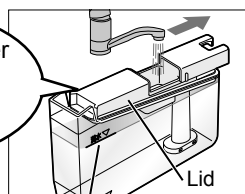

Add water up to the “満水” line.

③ Install the water supply tank.

Push the water supply tank in completely!

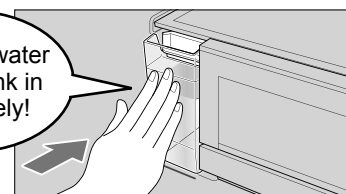

Hold the water supply tank horizontally. Confirm the direction of the tank and install securely. (If the tank is inclined, water may be spilled.)

To make ice quickly

■ When [QUICK ICE MAKING] is set, the speed of ice making is increased.

Ice can be made within 80 minutes* at the quickest.

① Press

The function setting section appears. (The indicator of function currently activated is lit.)

② Press to set Quick Ice Making function.

When setting is completed, turns on.

While Quick Ice Making is operated, is lit.

While usual Ice Making is operated, turns off.

- When you want to stop quick ice making in the middle, operate the control panel as described on the left. (The indicator turns off.)
- After approximately 6 hours, it returns to normal auto ice making.
- When defrosting is on, the indicator flashes. [QUICK ICE MAKING] re-starts automatically when defrost is completed.
- During quick ice making, energy consumption increases more than usual.
- If [FRESH FREEZING] is pressed during [QUICK ICE MAKING], QUICK ICE MAKING is canceled.
- ECONAVI does not operate while QUICK ICE MAKING has been set.

*Ambient temperature of 20 °C, temperature in each compartment set to “2”, doors not opened or closed.

To stop auto ice making

■ Stop auto ice making if you do not want to make ice and before cleaning the ice-making tray.

① Press

The function setting section appears. (The indicator of function currently activated is lit.)

② Press to stop auto ice making.

When setting is completed, turns on.

While AUTO ICE OFF is set, is lit.

- Operate the control panel as described above when you cancel AUTO ICE OFF.
- If the indicator bothers you, it can be turned off.

Requests

- There is a beep sound, then the indicator changes from flashing to lighting. Do not open the ice compartment door when the indicator is flashing. (Ice making cannot be stopped.)

Notices

- When you stop the auto ice making for a long term, empty the water supply tank and clean it. (P. 19)
- Ice in the middle of making is released after AUTO ICE OFF is canceled.

To turn off the indicator

■ The indicator can be turned off while the auto ice making is stopped.

Setting Procedure

Press and simultaneously. A beep sounds, and after a while the indicator turns off.

- To cancel, operate as described above.

Notices

- While the indicator is off, open the ice compartment door and the indicator turns on. When closing the door, the indicator turns off.

Freezer compartment

Approx. -20 °C ~ -18 °C

① Freezer case (Upper)*¹

A small piece of food may not get lost.

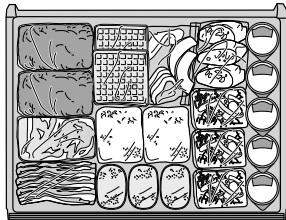

- Lift the handle and slide the case in the back.

② Freezer case (Middle)

A lot of small food items with thickness can be stored.

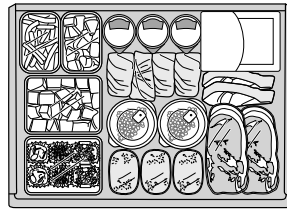

③ Freezer case (Lower)

Tall foods can be placed vertically.

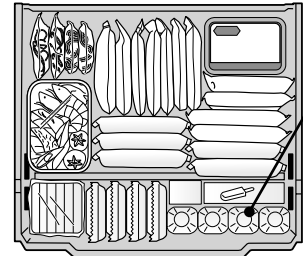

Freezable PET bottles*² can also be set up.

Vertical space

*1 NR-F503GT and NR-F503HX do not have the upper freezer case.

*2 Do not put other than the freezable PET bottle specified by the beverage manufacturer, such as a glass bottle.

Requests

- For the upper and middle cases of the freezer, put your food within the height of the case.
- For the lower case of the freezer, put your food below the upper limit line (↓食品はここまで↓) marked inside the case. (Otherwise, the door may not close completely and frost may occur.)
- Do not cram foods into the vertical space.

• Illustrations of NR-F603GT are used for explanation.

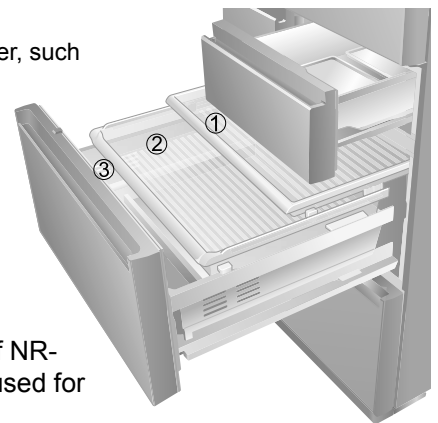

Vegetable compartment

Approx. 3 °C ~ 8 °C

- Cut vegetables, those to be stored for a long time or small quantity may require wrapping.

① Small-item vegetable case (Upper)

Put tomatoes and green peppers in the small-item vegetable case.

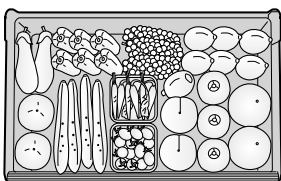

② Main vegetable case (Lower)

Put leafy vegetables, large vegetables, bottles or rice in the main vegetable case.

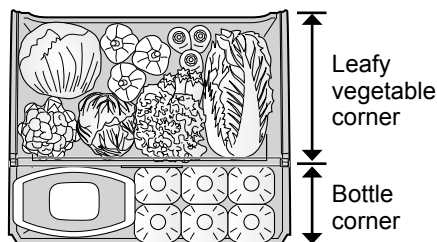

Leafy vegetable corner

Bottle corner

③ Bottle support*

The position of the bottle support can be changed.

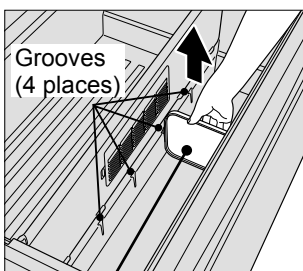

Grooves (4 places)

Pull the bottle support straight up and place it in your desired position!

* NR-F503GT and NR-F503HX do not have the bottle support.

• Illustrations of NR-F603GT are used for explanation.

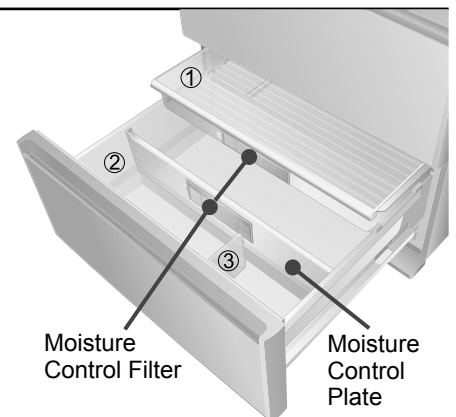

Moisture Control Filter

Moisture Control Plate

Requests

- The humidity in the vegetable compartment is high and condensation may occur. Just wipe off the waterdrop.
- For the small-item vegetable case, put your vegetables below the upper limit line (↑食品はここまで↑) marked inside the case.
- Put vegetables and fruits within the height of the leafy vegetable corner. (Otherwise, the door may not close completely, condensation may occur, or vegetables and fruits may have stuck and damaged.)

Cleaning, removing and re-installing

Before cleaning or conducting maintenance, be absolutely sure to disconnect the power plug from the wall outlet. Do not connect or disconnect the power plug with wet hands. Doing so may result in getting an electric shock or injury.

Cleaning

Clean the refrigerator immediately after it is stained.

Wipe off easily removable dirt using a cloth soaked in lukewarm water.

Wipe off stubborn dirt using a cloth soaked in diluted neutral detergent for kitchen.

Then take up the remaining detergent using a cloth soaked in lukewarm water.

Clean hidden areas at least once a year.

Remove dust accumulated on the wall outlet or the top surface and in gaps around the refrigerator.

Remove the leg cover when you do the cleaning. (P. 6)

When finger prints and stains cannot be removed easily, wipe them with a cloth lightly soaked in neutral kitchen detergent and then wipe with a wet cloth. Wipe again with a dry cloth to finish up. Doors are made of glass. Do not apply an impact on the surface and the end surface. (It may cause cracks.)

The fulcrum part of the rotation of the refrigerator compartment door has been coated with lubricant. Do not wipe it off.
→ If you wiped it off, consult your dealer.

For the door packing, wipe with a wet soft cloth, then wipe with a dry cloth to finish up. (Dirty packing gets damaged easily and it may cause leakage of cold air.)

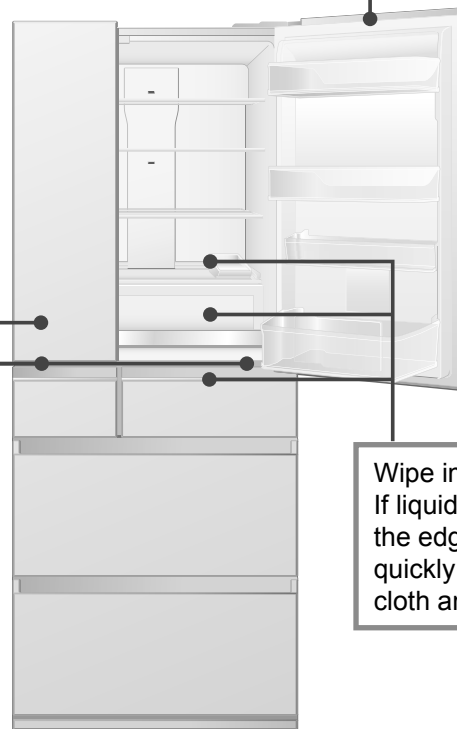

Wipe immediately! If liquid trickles at the edge of the door, quickly press a dry cloth and wipe it.

Attention

- Firmly wring the wet cloth. (If water enters gaps, it may lead to malfunction of electrical parts.)
- Do not use a dish washer/dryer for washing plastic parts such as the water supply tank and the washable ice-making tray. (It may cause deformation of the parts.)
- Do not use the following items for cleaning.



Alkaline or faintly alkaline

Kitchen detergents (other than neutral detergents), Glass detergents (chlorine bleach) (They crack plastic.)



Scrubber, Polishing sponger



Cleanser, Soap powder



Benzine, Thinner, Alcohol, Acid, Petroleum



Hot water

Moisture Control Filter

Whenever the dirt bothers you

Moisture Control Filter is fixed by the hook to the Moisture Control Plate.

Remove and rinse with water. (The Moisture Control Plate is not detachable.)

After rinse, drain the water well. Wipe off the waterdrop and reinstall.

For the stubborn dirt, wash gently with diluted kitchen detergent (neutral) and soft toothbrush, and then rinse away the detergent.

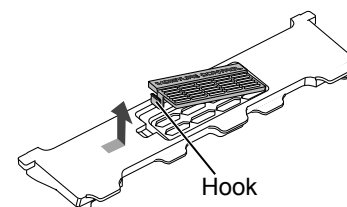

Hook

Attention

- Do not use the bleach or do not scrub. (Performance of the filter may be deteriorated.)

Trays / Slide tray (made of glass)

Once every 3 months

■ **Tray (Upper shelf in the refrigerator)**

Unhook the protrusion at the back of the tray and pull it.

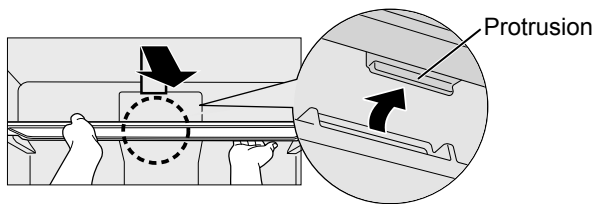

■ **Tray (2nd shelf from the top in the refrigerator)**

Lift up the back of the tray and pull it forward.

Once the protrusions of the tray are unhooked from the rails, tilt the tray and remove it.

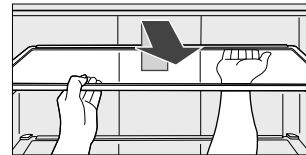

■ **Slide tray**

Lift the front half and slide inward, then stack and lift the pile of 2 shelves.

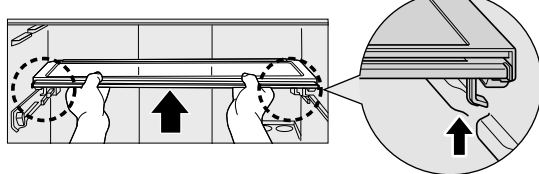

<Re-installing>

Lower the front part and slide backwards along the rail.

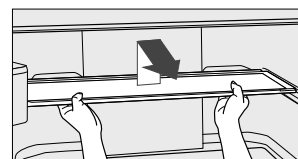

<Re-installing>

Place the pile of 2 shelves in the back, then pull the front half and slide forward.

Attention

- The partition shelf is not removable. When cleaning, wipe with a soft cloth without removing it.
- Trays, the slide tray and the partition shelf are made of glass and heavy. Please handle them with care so that they do not fall and cause any damage or injury.
- When the door cannot be fully opened and it is hard to remove the slide tray, slide the front half inward.

Case (Prime Fresh/Chilled select room)

Once every 3 months

■ **Removing**

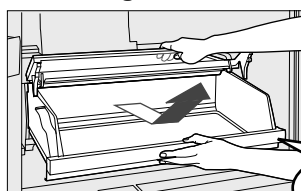

Pull out the case as far as possible. With lifting up the front, pull it out at an angle with holding the flap above the case.

The aluminum plate can be removed.

■ **Re-installing**

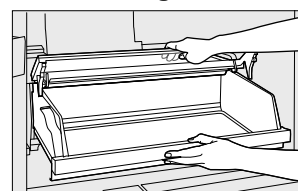

With holding up the flap, lift the back of the case and install it along the rails inside.

Attention

- Please take out the bottle shelf first when removing the case. (Otherwise, the bottle shelf may be damaged.)
- Please take out the case first when removing the aluminum plate. If the aluminum plate is washed with water, please reattach it after draining water and wiping the waterdrop remaining on it.
- The contact sections between the case and the right and left ends of the flap have been coated with lubricant. Do not wipe it off. → Consult your dealer if you wipe off.

Door shelf/Bottle shelf

Once every 3 months

■ **Removing**

Tap the bottom of the door shelves upward or slide alternately the left and right of the bottle shelves upward, and raise them slowly. (The shelves have been tightly attached.)



Slide the shelves upward.

■ **Re-installing**

Set each shelf horizontally, with the mark [>PS<] on the right, and push it down to its proper position.

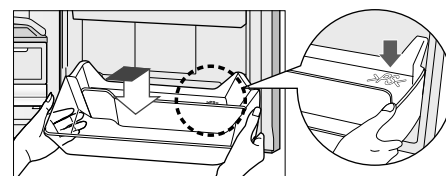

Water supply tank / Water purification filter

Once a week

- ① Remove the lid and clean the water supply tank with water.
- ② Turn the water purification filter to unhook and remove it.
- ③ Gently wash the water purification filter in water.
- ④ Remove the packing running on the edges from the back. Clean it with water.

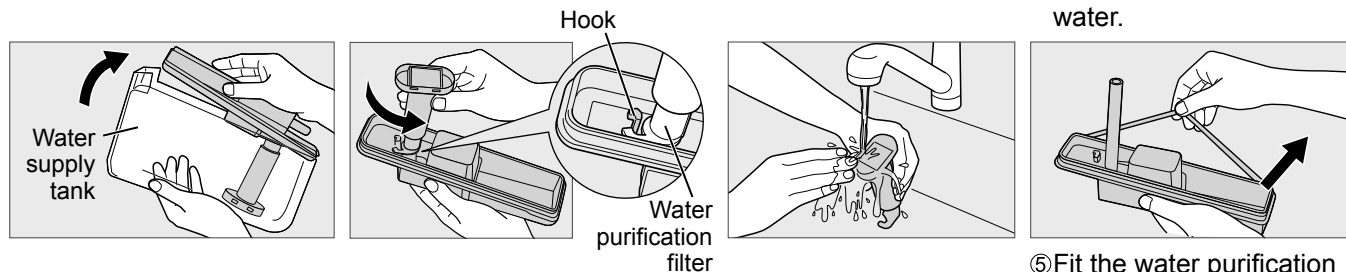

- ⑤ Fit the water purification filter and the packing.

- As a guide, replace the water purification filter every 3 years. (Separately sold parts: P. 27)
- If there is water scale on the water purification filter, ice may not be properly made.

Washable ice-making tray (Inside the ice compartment)

Once or twice a year

Remove the ice-making tray and rinse it.

- ① Press , then press **AUTO ICE OFF** and stop ice making.
(**AUTO ICE OFF** turns on. P. 15)
- ② Turn the knob in the ice compartment to the unlock position.
- ③ Pull forward the lever to pull out the ice-making tray.
- ④ Clean it with water. Do not rub the surface with a sponge etc.
(If the ice-making tray is scratched, ice may not be properly released, leading to a malfunction.)

- The ice-making tray and its frame cannot be separated.
- Do not use a dishwasher-dryer.

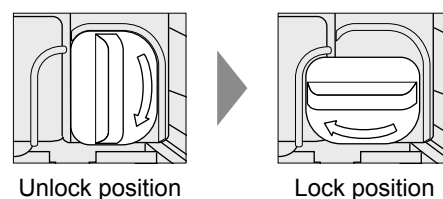
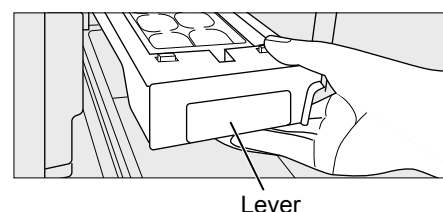
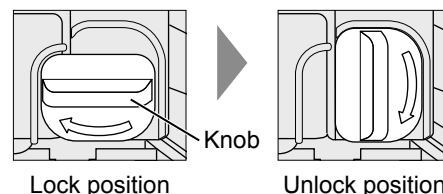

Re-installing

- ① Push in until it makes a clicking sound.
- ② Turn the knob to the lock position.
Ice may not be made if the ice-making tray is not locked.
- ③ Press , then press **AUTO ICE OFF** and re-start ice making.
(**AUTO ICE OFF** turns off. P. 15)
- Ice is not made until [AUTO ICE OFF] is canceled.
- Do not put water directly in the ice-making tray after cleaning.
(That may cause ice cubes sticking together or a malfunction.)

Case (Ice/Fresh Freezing/Freezer/Vegetable compartment)

Once every 3 months

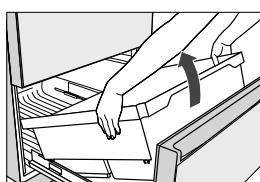

Pull out at an angle

Pull out the door as far as possible, and pull out at an angle while lifting up the front.

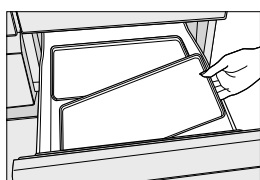

Remove the aluminum plate

Requests

- The contact sections of the drawer rails have been coated with lubricant. Do not wipe it off.
→ Consult your dealer if you wipe it off.
- When the top case in the freezer compartment or the small-item vegetable case has been removed, install by positioning “手前 FRONT” that is written on the bottom of the case on the front side.
- Do not touch the aluminum plate with wet hands, for example when cleaning the plate.
(It may cause a freezing injury.)
- When the case and the aluminum plate are washed, install them after draining water and wiping the remaining waterdrop.

Setting to suit your preferences

To adjust the temperature in more detail

- The temperature for refrigerator compartment and freezer compartment can be set in 9 stages, more detailed than as “ 1 ”, “ 2 ” and “ 3 ”.

(ECONAVI does not operate when the temperature is adjusted in detail.)

For the refrigerator compartment

Setting Procedure

- ① Press  twice and set the temperature of the refrigerator to setting “ 1 ”.
- ② Press and hold **FRIDGE** for at least 10 seconds.
(There is a beep sound and **2** turns on, then **1** (1st stage) turns on after 10 seconds.)
- ③ Press **FRIDGE** and select the stage of your choice.
(The stage goes higher every one press of **FRIDGE**.)
If **FRIDGE** is pressed when the 9th stage is set (**3** is on), the setting goes back to “ 1 ” (**1** is on).

ECONAVI does not operate even when the temperature setting is “ 2 ”.

Setting	Stage	Indicator
“ 3 ”	9	3
	8	2 3
	7	2 3
“ 2 ”	6	2 3
	5	2
	4	1 2
“ 1 ”	3	1 2
	2	1 2
	1	1

Indicator status

2 On **2** Flashing

Canceling Procedure

- ① Press  twice and set the temperature of the refrigerator to setting “ 1 ”.
- ② Press and hold **FRIDGE** for at least 10 seconds.
(There is a beep sound, then **1** turns on and **2** flashes.)
- ③ The cancellation of the detailed temperature setting is completed.
Set the temperature to fit your usual use.

For the freezer compartment

Operate above ① ~ ③ steps with pressing **FREEZER** instead of **FRIDGE**.

- The temperature of the prime fresh/chilled select room cannot be adjusted in detail.
- Set this when there is no indication on the notice indicator area.

To turn off the ECONAVI lamp

- The ECONAVI lamp can be turned off during ECONAVI operation. (P.9)

(Set this when there is no indication on the notice indicator area and the freezer compartment and refrigerator compartment are set to “ 2 ”.)

Setting Procedure

Press  twice, then press and hold **FRIDGE** for at least 3 seconds.



A beep sounds, the ECONAVI lamp flashes, and the setting is completed.
(After a short time, the ECONAVI lamp turns off.)

- ECONAVI operation is performed even if the above setting is set.

Canceling Procedure

Press  twice, then press and hold **FRIDGE** for at least 3 seconds.





There is a beep sound, then the ECONAVI lamp is on for 3 seconds, and the cancellation is completed.
(After a short time, the ECONAVI lamp turns off. However, it will remain on during ECONAVI operation.)

To adjust the brightness of nanoe™ X lamp

The brightness of nanoe™ X lamp can be adjusted. (P. 9)
(You can adjust only when the temperature setting indicator of PRIME FRESH is not flashing.)

Setting Procedure

Press  twice, then press and hold  for at least 10 seconds.



A beep sounds.

Press  to select your desired brightness. Approx. 10 seconds later, setting is completed.

Setting	1	2	3
Brightness	OFF	Dim	Bright

(The setting is "3" at the time of purchase.)

- Above setting does not affect the effect of nanoe™ X.
- To cancel, operate as above and set to "3" (Bright).

To lock operation on the control panel

You can lock the control panel so that the settings are not changed with unintended operation or operation by children.

Setting Procedure

Press and hold  for at least 3 seconds.



A beep sounds, "CL" appears in the notice indicator, and the setting is completed.
(After a short time, "CL" disappears in the notice indicator.)

- While lock function is activated and any key is pressed, "CL" appears in the notice indicator.
- To unlock, do the same operation as above.

Troubleshooting

If you feel that the refrigerator is not working properly, check out the following points first.

If the trouble persists, disconnect the power plug and contact your dealer or an authorized service center.

The following sounds are not abnormal.

From inside the refrigerator.

- Snapping sound
The sound of component parts expanding and contracting as a result of temperature changes.
- Zooming sound
The sound of the fan operating.
- Clattering sound
The sound of bottles in the door shelf being vibrating by operation of the compressor.

From upper part of the back.

- Clicking sound
The sound produced when the electrical components and compressor are operating.
- Zooming sound
The sound of the compressor operating. The sound pitch changes depending on the compressor rotation speed varied to match the temperature change.
- Rattling sound
The sound produced when the compressor stops.

From the ice compartment and water supply tank.

- Whirring, rattling and bubbling sounds
The sounds produced when ice is released by the automatic ice maker and water is supplied.

From the back.

- Bubbling, hissing and flowing sounds
The sounds of refrigerant (gas) flowing.

From the lower back.

- Whirring sound
The sound of the fan in the machine room.

When the freezer compartment door is opened.

- Hissing sound
The sound of water being evaporated by the heater during defrosting.
- Rapping and thudding sounds
The sound produced from the drawer rails when the drawers are opened/closed.

When the vegetable compartment door is opened.

- Rapping and thudding sounds
The sound produced from the drawer rails when the drawers are opened/closed.

• Illustrations of NR-F603GT are used for explanation.

Sound	Rattling noise	<ul style="list-style-type: none"> ● Place the refrigerator on a stout and flat floor, make both adjustable legs reach the floor and fixed the refrigerator. (P. 6) ● Do the sides or the back side of refrigerator or the power cord touch the walls or furniture around the refrigerator? → Place the refrigerator so that it does not touch surrounding objects.
	Noise bothers me.	<ul style="list-style-type: none"> ● The compressor or the fan may make loud noise when the refrigerator is being cooled, such as when the refrigerator is not still cooled soon after installation, the doors are frequently opened and closed, the temperature around the refrigerator is high or Fresh Freezing is set ON. This is not abnormal. → When the refrigerator has been cooled, the noise becomes small.
	Rapping noise	<ul style="list-style-type: none"> ● When the floor is uneven or the door is closed with a force, the refrigerator shakes and generates noise. → Place a plate under the refrigerator to prevent it from shaking. (P.6)
	There is a noise all the time.	<ul style="list-style-type: none"> ● It is because that the rotation speed of the compressor is adjusted with the inverter control. (Noise may not stop but it is not abnormal.)
Body	The top of the refrigerator is hot.	<ul style="list-style-type: none"> ● The mechanical section releases heat. (P. 7)
	Front (or side) panel is hot.	<ul style="list-style-type: none"> ● The left and right side surfaces may become hot to let out heat generated when the refrigeration system operates. The temperature may become 50 °C to 60 °C (when the ambient temperature is 30 °C) after installation or in the summer.
	The side surface looks warped.	<ul style="list-style-type: none"> ● In the manufacturing process, the warpage or surface waviness may occur, but this is not abnormal.
Display	Temperature setting on the control panel is flashing.	<ul style="list-style-type: none"> ● Has the temperature of the refrigerator compartment or the freezer compartment been adjusted in detail? (P. 20) → When the temperature is set in detail, the indicator flashes. Cancel the setting. (P. 20)
Door	The door is heavy when opening it immediately after closing.	<ul style="list-style-type: none"> ● Air taken into the interior is suddenly cooled. The inner pressure becomes lower than the external air momentarily. The doors seem to be pulled towards inside.
	Magnets do not stick to the doors.	<ul style="list-style-type: none"> ● The doors are made of glass. Magnets do not stick.
Ice making	Ice cannot be made.	<ul style="list-style-type: none"> ● When you use this refrigerator for the first time, ice will be made after the interior has cooled sufficiently. (24 hours or more may be required.) ● Make sure that [AUTO ICE OFF] is not set. (P. 15) ● Push in the water supply tank as far as it will go. Push in the ice-making tray until you hear a clicking sound. (P. 15) ● Make sure that the ice-making tray has been locked. (P. 19) ● Do not put foods etc. in the ice storage box. (P. 14) ● Take in and out the ice-making tray only when necessary. ● To confirm whether or not the ice maker is operating, press and hold [AUTO ICE OFF] for at least 10 seconds. If water in the water supply tank decreases, the ice maker is operating. • If water has spilled into the ice storage box, wipe it off. • If water does not decrease, the ice maker is not operating. → Consult your dealer.
	Inside the ice cube is not frozen.	<ul style="list-style-type: none"> ● Has the freezer compartment temperature control been set to “ 1 ” ? → Set it to “ 2 ” or “ 3 ”. (P. 8)
	The shape of ice is not “cubic”.	<ul style="list-style-type: none"> ● There are projections. → The groove of the ice-making tray may be frozen. ● The ice cubes are round or connected to other ice cubes. → Is the ice stored for a long time? (Ice cubes get round or connected by sublimation.) ● The ice is small. → Small ice cubes sometimes produced when no water remains in the tank.

Smell	Ice smells.	<ul style="list-style-type: none"> ● Clean the water supply tank and water purification filter once a week. (P. 19) ● Do not use cleaning agent or bleach for washing the water supply tank and the water purification filter. ● Replace the water purification filter every 3 year. (Separately sold part: P. 27)
	The interior smells.	<ul style="list-style-type: none"> ● Store strong smelling food in airtight containers. ● Odor often attaches to the interior walls. → Wipe the walls with a soft cloth soaked in lukewarm water.
Cooling	Does not get cold at all.	<ul style="list-style-type: none"> ● If dd is indicated in the notice indicator area of the control panel, cancel the demo mode. (P. 26) ● Make sure that there is no power failure, the power cord is connected to the outlet or the breaker is not operated.
	Does not get cold enough.	<ul style="list-style-type: none"> ● When you use the refrigerator for the first time, it will take 4 to 24 hours or more (in the summer time, etc.) until the refrigerator begins to cool. ● Change the temperature setting to the colder setting. (P. 8) ● Make sure that foods are not blocking the cold air outlet. (P. 2) ● Do not place the refrigerator where it is subjected to direct sunlight. (P. 6) ● Secure sufficient spaces around the refrigerator. (P. 6) ● It may take the refrigerator longer time to be cooled if food is stuffed too much or “Fresh Freezing” is used for a long time.
	Frost and dew	<ul style="list-style-type: none"> ● Do not keep the door open for a long time or open frequently when humidity is high. ● When a store bought accessory such as a tube stand is caught in the door, remove it. ● If food is fallen in the back from the case in the freezer compartment or the vegetable compartment, the door is not closed properly. Remove the food. ● Frost or dew may be formed on the outer surface of the refrigerator when humidity is high. → Wipe with a piece of dry cloth.
	The food is frozen.	<ul style="list-style-type: none"> ● Set the temperature setting to “2” (or “1”). (P. 8) ● Is the ambient temperature 5 °C or below? → Set the temperature setting to “1”. (P. 8) ● Do not put food with high water content near the cold air outlet in the refrigerator (P. 2) or in the prime fresh/chilled select room.
Prime Fresh	Prime Fresh Quick Mode is stopped soon, or stopped in the middle of operation.	<ul style="list-style-type: none"> ● In the following cases, the time for the quick mode may become short (it returns to the normal Prime Fresh operation from the quick mode shortly). <ul style="list-style-type: none"> • Immediately after the completion of the quick mode. • When the refrigerator judges the quick mode is not necessary based on the amount of food or temperature. • During defrosting. • When the temperature of the refrigerator compartment or the freezer compartment is high. ● Depending on the usage conditions, the quick mode may stop and re-start after the temperature inside the compartment is stable.

In these cases?

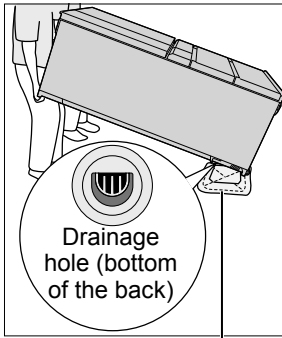
<p>The power failed.</p>	<ul style="list-style-type: none"> ● Keep the doors closed and do not store additional food. ● [FRESH FREEZING] and [QUICK ICE MAKING] stop. Set these functions again to use after power recovery.
<p>The power plug was disconnected.</p>	<ul style="list-style-type: none"> ● Wait at least 7 minutes, and then plug in the power plug. (If it is plugged in immediately, the compressor will be overloaded, which may cause a malfunction.)
<p>The refrigerator is not used for a long time.</p>	<ul style="list-style-type: none"> ● Remove all foods and drinks and clean the refrigerator. <ol style="list-style-type: none"> ① Disconnect the power plug. ② Clean the compartments and the ice-making tray. (P. 17 ~ P. 19) ③ Keep the doors opened for 2 to 3 days to dry the compartments. (When drying is insufficient, the compartment may get moldy or have a foul smell.)
<p>The room lamp does not turn on.</p>	<p>→ Consult your dealer. (When the room lamps are flashing, see P. 26.)</p>
<p>Glass was broken. (Glass trays • doors)</p>	<ul style="list-style-type: none"> ● When glass trays and glass doors were broken, do not touch the broken glass. → Contact your dealer immediately.
<p>Moving the refrigerator.</p>	<ul style="list-style-type: none"> ● To prevent the floor surface from being damaged, place a protective board or the like. <ol style="list-style-type: none"> ① Disconnect the power plug. ② Remove the leg cover, and then raise the adjustable legs. (P. 6) ③ Move the refrigerator in the forward or backward direction. ④ After moving, fix the refrigerator completely with adjustable legs. Reattach the leg cover. (P.6)
<p>When you move or transport the refrigerator.</p>	<ul style="list-style-type: none"> ● Transport the refrigerator with at least 2 people. Do not transport it in a horizontal position. (It may cause an injury or break down of the refrigerator.) <ol style="list-style-type: none"> ① Remove the food and drinks and discard water in the water supply tank. ② Stop the auto ice making function. (P. 15) ③ Clean the ice-making tray. (P. 19) ④ Disconnect the power plug. ⑤ Remove the leg cover screw in the adjustable legs. (P. 6) (Remove the leg cover before transporting the refrigerator.) ⑥ Place a vessel underneath the drainage hole (whose height is 2 cm or less). ⑦ Tilt the refrigerator backward to drain water from the drainage hole. (To prevent water from leaking out, tilt back the refrigerator slowly.) ⑧ Place a protective sheet or the like and move the refrigerator. (Since water may remain the inside.) <div data-bbox="1189 1171 1481 1507" style="text-align: right;">  <p>Drainage hole (bottom of the back)</p> <p>Place container and rag. (Water may overflow.)</p> </div> <div data-bbox="501 1626 687 1675" style="border: 1px solid black; border-radius: 15px; padding: 5px; text-align: center;"> <p>Attention</p> </div> <ul style="list-style-type: none"> ● If frost remains on the cooling unit (not visible from the outside) in the refrigerator, water may spill when it is moved. (It takes approximately 15 hours for the frost on the cooling unit to melt after the refrigerator power plug is disconnected.)

The automatic ice maker is not used for a long time.

- Stop ice making, with the water supply tank empty, and clean the ice maker.
 - ① Discard water in the water supply tank.
 - ② Press , then press **AUTO ICE OFF** and stop ice making. (P. 15)
(**AUTO ICE OFF** turns on.)
 - ③ Discard the stored ice in the ice-making tray and the ice storage box.
 - When the ice is stored for a long time, ice cubes get round or connected by sublimation.
 - ④ Rinse the ice storage box, ice shovel and water supply tank. Wipe off the water and return them to their original positions.
 - Dry the water purification filter thoroughly. (The water purification filter contains moisture. If it is not dried thoroughly, it may cause molds or smell.)

→ When starting to use the automatic ice maker again, cancel the “AUTO ICE OFF”. (P. 15)

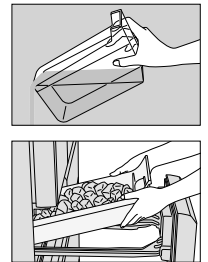

If the following sounds or indications are generated

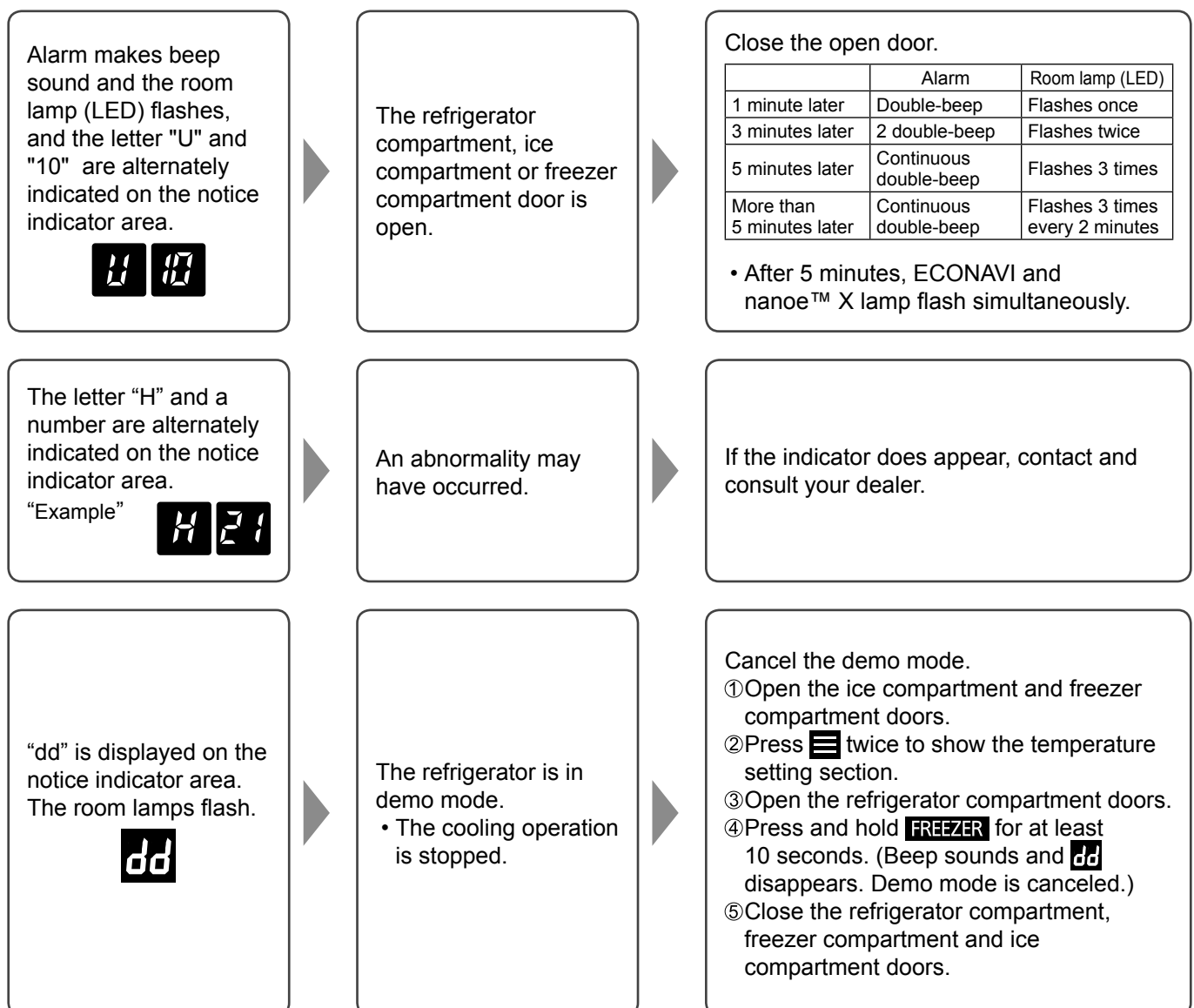

Specifications

MODEL	NR-F654GT-X6 NR-F654HX-X3	NR-F603GT-X6 NR-F603GT-W6 NR-F603GT-N6 NR-F603HX-X3 NR-F603HX-W3 NR-F603HX-N3	NR-F603GT-XP	NR-F603GT-XU NR-F603GT-WU	NR-F503GT-X6 NR-F503GT-W6 NR-F503GT-T6 NR-F503GT-T7 NR-F503HX-X3 NR-F503HX-W3 NR-F503HX-N3
TOTAL GROSS VOLUME	684 L	628 L	589 L	628 L	528 L
TOTAL STORAGE VOLUME	534 L	488 L	488 L	492 L	402 L
STORAGE FRIDGE VOLUME	327 L	301 L	301 L	304 L	250 L
STORAGE ICE VOLUME	8 L	5 L	5 L	5 L	4 L
STORAGE FRESH FREEZING VOLUME	18 L	18 L	18 L	18 L	14 L
STORAGE FREEZER VOLUME	85 L	77 L	77 L	78 L	63 L
STORAGE VEGETABLE VOLUME	96 L	87 L	87 L	87 L	71 L
OUTSIDE DIMENSIONS WIDTH×DEPTH×HEIGHT	750 mm × 745 mm × 1828 mm	685 mm × 745 mm × 1828 mm			650 mm × 699 mm × 1828 mm
WEIGHT	123 kg / 271 lb	114 kg / 251 lb			105 kg / 231 lb
RATED VOLTAGE RATED FREQUENCY	Indicated on the quality indication label on the inside of the refrigerator compartment door.				

- The volume of models other than NR-F603GT-XP, NR-F603GT-XU and NR-F603GT-WU is based on IEC 62552.
- The volume of NR-F603GT-XP is based on ISO 8561.
- The volume of NR-F603GT-XU and NR-F603GT-WU is based on AS/NZS 4474.

Separately sold parts

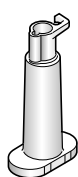

Water purification filter for water supply tank (P. 19)
ARMH00B00820

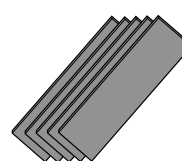

A set of adjustment plates (P. 6)
CNR79-338120

Kandungan

Pengenalan	Arahan keselamatan.....	29
Pemasangan	Pemasangan	32
	Memilih lokasi yang betul	32
Operasi	Untuk menggunakan semua ciri	33
	Tetapan suhu dan panduan suhu	33
	Panel kawalan	34
	Cara penggunaan.....	34
	Operasi ECONAVI.....	35
	Operasi nanoe™ X.....	35
	Petak Peti Sejuk.....	36
	Ruang pilih Segar Asli/Dingin	38
	Petak Pembekuan Segar	39
	Petak Ais	40
	Petak Pembeku	42
	Petak Sayuran.....	42
Lampiran	Mencuci, menanggalkan serta memasang semula	43
	Pembersihan	43
	Penetapan yang sesuai dengan kehendak anda	46
	Menyelesaikan masalah.....	48
	Dalam kes-kes sebegini?.....	51
	Jika bunyi atau penunjuk yang berikut dihasilkan.....	52
	Spesifikasi.....	53
	Bahagian yang dijual berasingan	53

- Produk ini sesuai untuk digunakan dalam kelengkapan rumah dan kegunaan yang sama seperti
 - kawasan dapur kakitangan di kedai, pejabat dan persekitaran kerja yang lain;
 - rumah ternakan dan kegunaan oleh pelanggan di hotel, motel dan persekitaran tempat tinggal yang lain;
 - persekitaran penginapan dan sarapan;
 - katering dan kegunaan bukan perniagaan yang seumpamanya.

■ Untuk menjimatkan tenaga

- Jangan penuhkan makanan ke dalam petak. Ia boleh mengganggu aliran udara sejuk. Sediakan ruang mencukupi di antara makanan.
- Buka pintu hanya apabila perlu. Meminimumkan bilangan pintu dibuka/ditutup bagi menghalang udara sejuk daripada keluar dan mengurangkan pembaziran elektrik.
- Jangan menghalang lubang udara sejuk dengan makanan. Jika udara sejuk tidak merebak ke setiap sudut petak, bahagian dalam tidak akan cukup sejuk dan lebih banyak elektrik akan digunakan.
- Udara sejuk dilepaskan dari lubang salur di bahagian belakang.
- Sejukkan makanan dan minuman terlebih dahulu sebelum disimpan di dalam peti sejuk. Jika tidak, ia bukan sahaja akan meningkatkan suhu bahagian dalam, tetapi juga memberi kesan pada kesegaran makanan lain.

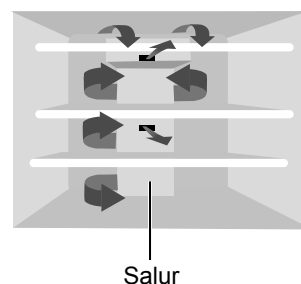

■ Melupuskan pembungkusan



Sila kitar semula jika boleh (contoh: kadbod, beg plastik, pita pelekat dan polistirena) dan pastikan anda melupuskan semua bahan pembungkusan lain dengan selamat.

Pastikan pembungkusan jauh daripada capaian bayi dan kanak-kanak untuk mengelakkan kecederaan atau kejadian lemas.

Arahan keselamatan

Maksud simbol.

 Jangan	 Pastikan anda lakukan ini	 Menunjukkan alat mestilah dialirkan ke bumi untuk mencegah kejutan elektrik
 Jangan tanggalkan	 AMARAN; Risiko kebakaran/bahan mudah terbakar	



Menunjukkan risiko kematian atau kecederaan serius.



- AMARAN: Jangan menggunakan peralatan mekanikal atau cara lain untuk mempercepatkan proses nyahfros, selain daripada cara yang disyorkan oleh pengilang.
- AMARAN: Jangan merosakkan litar pendingin.
(Jika tidak, bahan pendingin mudah terbakar boleh terbakar dan membawa kepada letupan.)
- AMARAN: Jangan gunakan alat elektrik dalam petak simpanan makanan bagi produk, melainkan ianya jenis yang disyorkan oleh pengeluar.
(Jika pendingin bocor, ia boleh terbakar akibat percikan api daripada sentuhan.)
- Jangan menyimpan bahan mudah meletup seperti tin aerosol dengan bahan dorong mudah terbakar di dalam produk ini.
- AMARAN: Jangan memasang berbilang soket alur keluar atau bekalan kuasa mudah alih di bahagian belakang perkakas.



- Alat ini bukan disasarkan untuk digunakan oleh orang (termasuk kanak-kanak) dengan kecacatan fizikal, deria atau mental, atau yang kurang pengalaman dan pengetahuan, kecuali jika mereka telah diberikan pengawasan atau arahan mengenai penggunaan alat ini oleh orang yang bertanggungjawab atas keselamatan mereka.
Kanak-kanak harus diawasi bagi memastikan mereka tidak bermain dengan alat ini.
- Jika kord kuasa atau plag perkakas rosak, ia mestilah digantikan oleh pengilang atau ejen perkhidmatan mereka atau individu yang memiliki kelayakan yang sama bagi mengelakkan bahaya.
- AMARAN: Isi dengan air minuman sahaja.
- AMARAN: Pastikan injap pengudaraan, di dalam ruangan peti sejuk atau di dalam struktur kabinet, tidak dihalang.
- AMARAN: Apabila meletakkan perkakas, pastikan bahawa kord tidak terperangkap atau rosak.

Untuk plag kuasa dan kord...



- Jangan menggunakan kord sambungan.
- Jangan memasukkan atau mencabut plag kuasa ke dalam/dari soket dinding dengan tangan yang basah.
- Jangan merosakkan plag kuasa atau kord. Jangan memotong atau memproses plag atau kord; jangan didedahkan kepada suhu yang tinggi; jangan melentur, memutar atau menarik secara berlebihan; jangan meletakkan objek berat di atasnya; dan jangan menyusunnya dalam longgokan.
→ Hubungi wakil pendedar anda untuk membaiki plag atau kord.
- Jangan menolak belakang peti sejuk rapat ke plag kuasa.
- Jangan gunakan ketika kord atau plag kuasa rosak, atau ketika plag tidak dimasukkan sepenuhnya ke dalam soket.



- Dari semasa ke semasa buang kotoran seperti habuk dari plag kuasa.
- Pasangkan plag ke dalam soket dinding yang sama voltan dengan arus dan masukkan plag sepenuhnya.
- Apabila mencabut plag kuasa, pegang pada plag bukan pada kordnya.
- Cabut plag ketika membersihkan peti sejuk.
- Jika anda tidak bercadang untuk menggunakan peti sejuk bagi tempoh yang panjang, cabut plagnya.
(Jika tidak, ia boleh menyebabkan kebakaran atau kejutan elektrik)
- Jika kord kuasa atau palam perkakas rosak, ia mestilah digantikan oleh pengilang atau ejen perkhidmatan mereka atau individu yang memiliki kelayakan yang sama bagi mengelakkan bahaya.

Berhenti menggunakan peti sejuk serta merta dan cabut plag, jika terdapat keabnormalan atau kegagalan.

(Jika tidak, ia boleh menyebabkan asap, kebakaran atau kejutan elektrik.)



Contoh-contoh keabnormalan dan kegagalan

- Kord atau plag kuasa menjadi terlalu panas
- Kord kuasa terpotong atau cacat
- Terdapat bau terbakar
- Anda boleh merasakan getaran elektrik

Hubungi pengedar anda dengan segera untuk pemeriksaan dan pembaikan.

Di atas peti sejuk...



- Jangan meletakkan apa-apa pun. Jika tidak, ia mungkin jatuh akibat getaran dan menyebabkan kecederaan.
- Jangan meletakkan apa-apa pun pada penutup atas. (Jika tidak, bahagian tersebut boleh menjadi cacat dan boleh menyebabkan kejutan elektrik.)

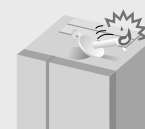

Ketika menggunakan...



- Jangan bergayut atau menaiki pintunya.
- Jangan sapukan air pada badan atau bahagian dalam. (Jika tidak, penebat elektrik menjadi lusuh dan boleh menyebabkan kejutan atau kebakaran.)
- Jangan menyentuh perkakasan di atas dulang membuat ais.
- Jangan mengeluarkan dulang pembuatan ais ketika fungsi membuat ais beroperasi.
- Jangan menyimpan bahan mudah terbakar di dalam peti sejuk.
- Jangan menyimpan bahan kimia atau spesimen sains.
- Jangan menyembur bahan kimia mudah terbakar berhampiran peti sejuk.
- Jangan mengenakan impak tinggi pada pintu kaca. (Jika tidak, kaca boleh pecah dan menyebabkan kecederaan.)
→ Jika ia didapati retak, jangan sentuh kaca dan rujuk kepada wakil pengedar anda dengan segera.



- Kanak-kanak harus diawasi bagi memastikan peti sejuk digunakan dengan cara yang betul.

Ketika memasang...



- Jangan memasang produk di lokasi yang terdedah kepada air.
- Jangan mengisi rongga di sekeliling peti sejuk. (Jika pendingin bocor, ia boleh terbakar.)



- Menyediakan langkah keselamatan jika peti sejuk terbalik disebabkan oleh keadaan seperti gempa bumi.



- Pastikan plag peti sejuk dipasangkan ke dalam soket utama yang dialirkan ke bumi. Jangan memasang plag ke dalam soket utama yang tidak dialirkan ke bumi. (Plag 3 pin)

Ketika membuang dan mengitar semula produk...



- Sekiranya anda bimbang kanak-kanak mungkin masuk semasa mengitar semula produk, buang pembungkus pintu.
- Pendingin menggunakan gas mudah terbakar. Dan Cyclo-Pentana digunakan sebagai penebat untuk peti sejuk ini. Apabila anda membuang produk ini, sila lupuskannya mengikut cara yang betul.
- Label amaran yang dinyatakan di atas mesti disimpan sepanjang penggunaan peti sejuk ini. Manual ini hendaklah diserahkan kepada mana-mana individu yang akan menggunakan atau mengendalikan peti sejuk apabila peti sejuk akan dipindahkan ke mana-mana lokasi lain atau dihantar ke kilang kitar semula.

Dalam keadaan kecemasan...

- Jangan sesekali membuka penutup atas dan penutup belakang.
- Jangan sesekali memisahkan, membaiki atau mengubah suai peti sejuk.
(Jika tidak, boleh menyebabkan kecederaan, lecur atau kejutan elektrik.)



- Jika anda mengesan kebocoran gas (seperti gas rumah), jangan sentuh peti sejuk dan buka tingkap untuk pengudaraan di dapur.
- Bahan pendingin mudah terbakar digunakan. Jika anda telah merosakkan litar penyejukan (perpaipan), buka tingkap untuk pengudaraan di dapur dan hubungi wakil pengedar.
- Kerja penyelenggaraan hanya boleh dilakukan di bengkel oleh kakitangan penyelenggaraan yang terlatih.
(Jika tidak, ia boleh menyebabkan kejutan elektrik, nyalaan api dan letupan.)



PERINGATAN

Menunjukkan risiko kecederaan atau kerosakan harta benda.**Ketika menyimpan makanan...**

- Jangan mengenakan impak tinggi pada dulang kaca.
(Jika tidak, dulang kaca mungkin pecah dan menyebabkan kecederaan.)
- Jangan membiarkan makanan terjulur dari rak kaca.
- Jangan simpan bekas makanan di rak pintu jika ia tidak menyentuh bahagian bawah rak.
(Jika tidak, makanan mungkin terjatuh dan menyebabkan kecederaan.)
- Jangan membekukan botol.
(Jika cecair di dalam botol kaca membeku, botol mungkin pecah dan menyebabkan kecederaan.)
- Jangan menyentuh makanan beku atau bekas (terutama logam), plat aluminium dengan tangan yang basah.
(Jika tidak, anda boleh mengalami luka beku.)
- Jangan makan makanan yang mempunyai bau pelik atau berubah warna.
(Makanan busuk boleh menyebabkan penyakit.)

Ketika membuka/menutup pintu...

- Jangan buka/tutup pintu jika sesuatu tersentuh dengan peti sejuk.
- Jangan masukkan jari anda pada rongga di bahagian sisi pintu petak peti sejuk ketika membuka/menutup pintu.
- Jangan buka/tutup petak ais dan petak pembekuan segar (fresh freezing) dengan memegang bahagian atas laci.
- Jangan meletakkan kaki anda di bawah laci sebelah bawah.
(Jika tidak, kaki anda mungkin tersepit.)
- Jangan membuka atau menutup pintu dengan kuat.
(Jika tidak, makanan mungkin terjatuh dan menyebabkan kecederaan.)

**Ketika membersihkan...**

- Jangan menyentuh rel logam.
- Jangan meletak tangan atau kaki di bawah bahagian bawah peti sejuk.
(Sisi panel logam boleh menyebabkan kecederaan.)



- Berhati-hati ketika anda memasukkan atau mengeluarkan rak kaca.
(Sekiranya terjatuh, rak kaca mungkin rosak atau jika pecah, ia boleh menyebabkan kecederaan.)

Ketika memindah atau mengangkut peti sejuk...

- Betulkan kedudukan peti sejuk pada kaki boleh laras di atas lantai rata dan kuat.
(Jika tidak, peti sejuk boleh bergoyang atau terbalik dan boleh menyebabkan kecederaan.)
- Guna lapik perlindungan, dll. untuk permukaan lantai yang mudah rosak.
- Semasa mengangkut peti sejuk, pegang pemegang dan pindahkan dengan bantuan sekurang-kurangnya 2 orang.
(Jika tidak, tangan anda mungkin terlepas dan menyebabkan kecederaan.)



Pemasangan

Memilih lokasi yang betul

1. Letakkan peti sejuk di lokasi-lokasi berikut.

- Lokasi yang tidak panas dan tidak kena cahaya matahari
Meminimumkan pengurangan kuasa penyejukan, dan mengelakkan pembaziran elektrik.
- Lokasi dengan pengudaraan yang baik serta kelembapan rendah
Mengurangkan karat dan penghasilan pemeluwapan.
- Permukaan lantai yang keras dan rata
Dengan karpet, tikar tatami atau lantai vinil, perubahan bentuk atau warna boleh berlaku, jadi letakkan papan di bawah peti sejuk.
- Letakkan peti sejuk jauh dari peralatan lain
Mencegah gangguan bunyi dan paparan gambar pada TV dan peralatan lain.
- Lokasi yang membolehkan plag kuasa dibersihkan dengan mudah
Kerap bersihkan habuk.
(Untuk mengelakkan kebakaran disebabkan habuk.)
- Lokasi yang membolehkan haba dibebaskan
Letakkan peti sejuk jauh dari dinding (30mm atau lebih) apabila bunyi getaran dan penyahwarnaan atau pemeluwapan pada permukaan belakang mengganggu anda.

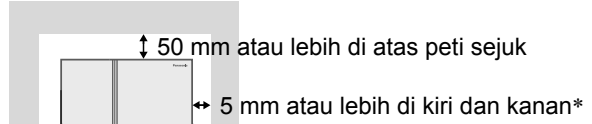

* Sekiranya memasang di sebelah dinding.
(Gambar pandangan dari atas.)

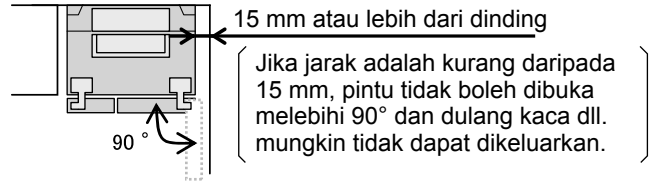

■ Sebelum menggunakan peti sejuk buat pertama kali. (Hal. 43 ~ Hal. 45)

- Lap bahagian dalam peti sejuk dengan kain basah yang lembut.
- Bilas tangki bekalan air, penapis penulenan air dan dulang membuat ais.

2. Betulkan kedudukan peti sejuk.

- Jika peti sejuk tidak distabilkan sepenuhnya, anda akan mendengar bunyi ketukan apabila pintu dibuka/ditutup. (Ini tidak menjejaskan prestasi.)
Letakkan peti sejuk di atas lantai yang keras dan rata.
- Periksa sama ada pintu kanan dan kiri ruang peti sejuk adalah selari. Jika tidak selari, laraskan aras pintu menggunakan alat khas untuk kaki boleh laras.
- Pintu peti sejuk boleh menurun sedikit disebabkan oleh sudut kecondongan tapak pemasangan atau lantai yang digunakan.
- Semasa pembelian, alat khas untuk melaras kaki boleh laras disertakan bersama penutup kaki. Selepas digunakan, anda boleh menyimpannya semula di bahagian belakang penutup kaki.

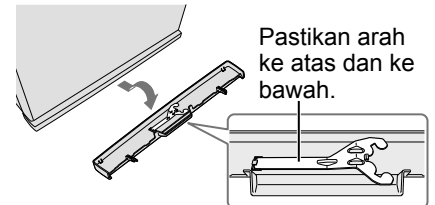

① Keluarkan penutup kaki.

Letakkan tangan di bawah "▼" pada kedua-dua belah penutup kaki dan tarik keluar.

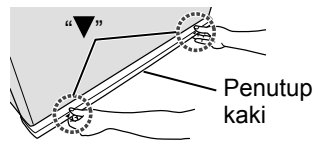

② Putarkan kaki boleh laras (kanan dan kiri) sehingga ia menyentuh lantai bagi menstabilkan peti sejuk.

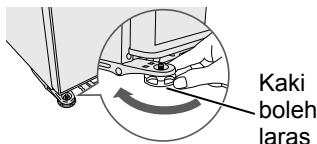

③ Jika pintu telah menurun sedikit, putarkan kaki boleh laras dengan alat khas dan laraskan aras agar pintu kembali selari.

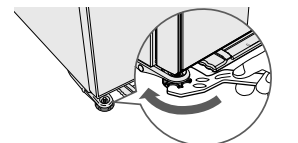

④ Pasangkan semula penutup kaki.

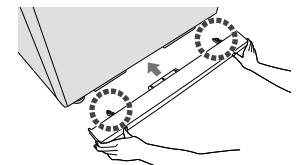

■ Jika pintu condong ke bawah.

Putarkan kaki boleh laras pada sisi yang lebih rendah, seperti yang ditunjukkan di dalam ilustrasi di sebelah hak, untuk melaraskan paras.

- Pintu penyejuk beku/peti sejuk mungkin akan condong dalam masa 4 hingga 5 hari selepas pemasangan disebabkan oleh berat makanan atau penyesuaian dengan permukaan lantai. Dalam kes sebegini, putarkan lagi kaki boleh laras untuk membetulkannya.
- Jika keadaan ini tidak boleh dibetulkan dengan kaedah ini, gunakan plat pelarasan. (Bahagian yang dijual berasingan: Hal. 53)

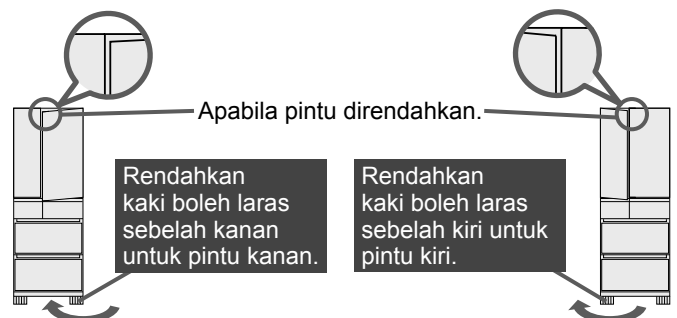



3. Pasang plag ke dalam soket dinding.

Pasangkan plag ke dalam soket dinding yang sama voltan dengan arus dan masukkan plag sepenuhnya.

- Plag kuasa boleh dipasang ke dalam soket sejurus selepas pemasangan.
- Persekitaran dan permukaan (permukaan sisi) peti sejuk boleh menjadi panas (kira-kira 50 °C hingga 60 °C ketika suhu sekeliling adalah 30 °C) ketika kuasa dihidupkan, tetapi ini bukannya abnormal. (Hal. 49)
- Jika plag kuasa dicabut, tunggu sekurang-kurangnya 7 minit sebelum memasang semula plag. (Hal. 51)
- Jika tiada plag pendawaian pbumian di dalam peti sejuk, ia perlu disambungkan dengan sambungan pbumian atau mencegah bahaya elektrik daripada kebocoran elektrik.

Untuk keselamatan, peti sejuk harus dibumikan (Untuk peti sejuk dengan plag 2 pin tanpa dawai bumi)

Sambungan bumi akan mencegah bahaya daripada kejutan elektrik.
Sambungan bumi boleh dibuat dengan salah satu dari 2 cara berikut:

1. Apabila menggunakan soket dengan peranti pbumian, sambung wayar bumi kepadanya dan skru untuk sambungan bumi di belakang peti sejuk (sila cari simbol ) seperti ditunjukkan dalam ilustrasi ①.
2. Apabila menggunakan soket dengan tanpa peranti pbumian, sambung wayar bumi pada skru untuk sambungan bumi di belakang peti sejuk (sila cari simbol ) , kemudian sambungkan hujung satu lagi kepada rod bumi seperti ditunjukkan dalam ilustrasi ②.

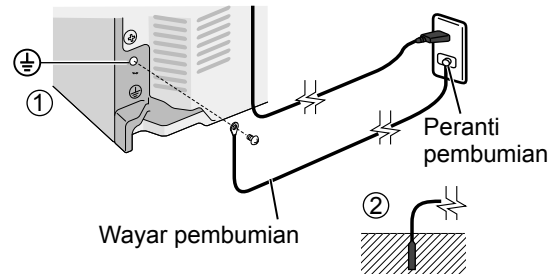

Sambungan bumi tidak boleh dibuat dengan yang berikut

- Paip gas dan paip bekalan air (risiko kejutan elektrik atau letupan)
- Wayar bumi kord telefon dan rod kilat (risiko panahan petir)

4. Sejukkan bahagian dalam peti sejuk.

- Ia mungkin mengambil masa sekitar 4 jam untuk menyejukkan bahagian dalam.
- Ia mungkin mengambil masa 24 jam atau lebih untuk menyejukkan bahagian dalam dan mencapai keseimbangan pada musim panas, dll.
- Mula membuat ais hanya selepas bahagian dalam telah cukup sejuk.
- Jangan buka/tutup pintu sehingga bahagian dalam cukup sejuk. (Udara hangat yang masuk ke bahagian dalam akan menghalang fungsi penyejukan.)

Permintaan

■ Jangan letakkan barang di atas peti sejuk.

Ini mungkin menjadi panas disebabkan kepanasan yang dihasilkan oleh pemampat di bahagian atas peti sejuk. Jika ia sukar melepaskan haba, kapasiti penyejukan boleh diturunkan.

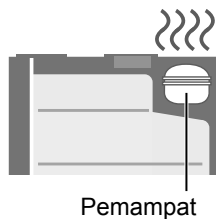

Notis

- Sejurus selepas pemasangan, bunyi yang menjadi lebih kuat sedikit kerana bahagian dalam peti sejuk masih belum sejuk dan pemampat atau kipas beroperasi pada putaran kelajuan tinggi, tetapi ia bukannya abnormal. (Setelah bahagian dalam peti sejuk menjadi sejuk, bunyi akan berkurangan.)

Untuk menggunakan semua ciri

Tetapan suhu dan panduan suhu

Tetapan suhu	CHILLED	1	2	3
FRIDGE		Anggaran 2 °C ~ 3 °C lebih tinggi daripada " 2 "	Anggaran 3 °C ~ 6 °C	Anggaran 2 °C ~ 3 °C lebih rendah daripada " 2 "
FREEZER		Anggaran 2 °C ~ 3 °C lebih tinggi daripada " 2 "	Anggaran -20 °C ~ -18 °C	Anggaran 2 °C ~ 3 °C lebih rendah daripada " 2 "
PRIME FRESH	Anggaran 0 °C ~ 2 °C	Anggaran 1 °C ~ 2 °C lebih tinggi daripada " 2 "	Anggaran -3 °C ~ -1 °C	Anggaran 1 °C ~ 2 °C lebih rendah daripada " 2 "

(Ini ialah penunjuk secara kasar ketika suhu sekeliling sekitar 32 °C, tiada makanan yang disimpan di dalam peti sejuk dan suhu bahagian dalam telah stabil. Suhu mungkin berbeza bergantung kepada suhu sekeliling, keadaan penyimpanan makanan, membuka/menutup pintu dan keadaan penggunaan yang lain.)

Untuk menggunakan semua ciri

Panel kawalan

Biasanya, bahagian tetapan fungsi dan bahagian tetapan suhu tidak dapat dilihat.

Tekan  sekali untuk menunjukkan bahagian tetapan fungsi.

Tekan  dua kali untuk menunjukkan bahagian tetapan suhu.

Tekan  tiga kali untuk menyembunyikan bahagian tetapan fungsi dan suhu.

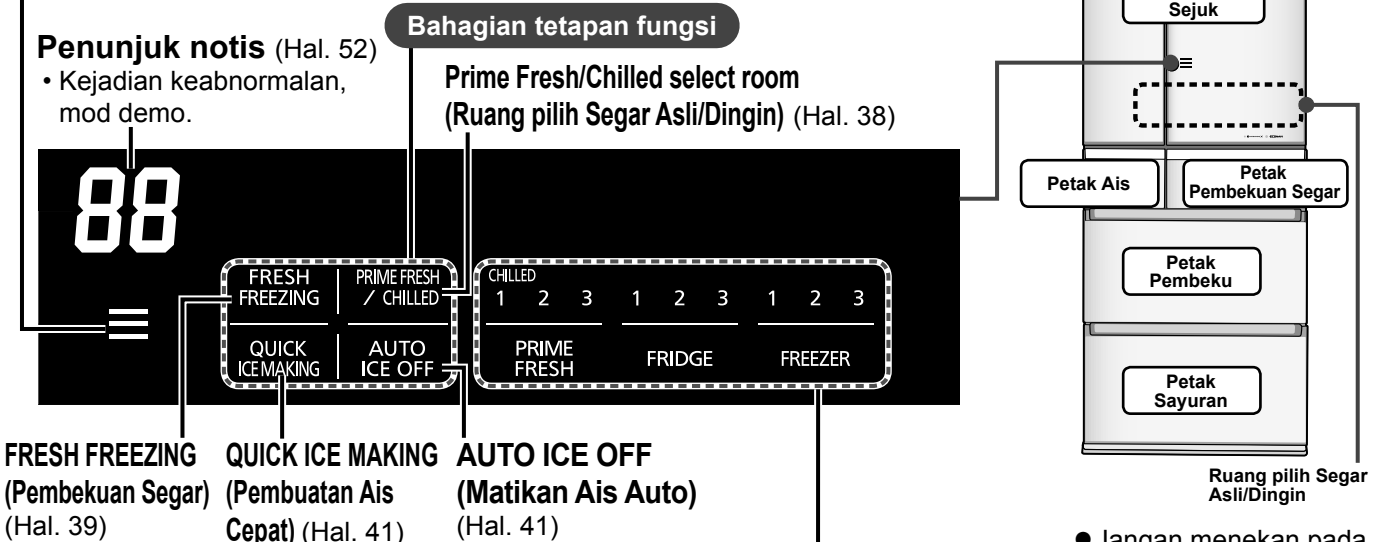

Biasanya, gunakan peti sejuk dengan suhu ditetapkan kepada "2".
Gunakan panel kawalan jika anda ingin menukar tetapan suhu.

(Jika kawalan suhu petak pembeku atau petak peti sejuk ditetapkan selain daripada "2" semasa operasi ECONAVI berhenti.)

● Sila lihat "Paparannya" (Hal. 49) ketika lampu tetapan suhu berkelip.

- Anda boleh menukar tetapan hanya apabila pintu petak peti sejuk ditutup.
- Apabila "CL" muncul di penunjuk notis, fungsi kunci operasi telah diaktifkan. (Hal. 47)

Cara penggunaan (Contoh: Untuk menggunakan fungsi ruang pilih sebagai ruang segar asli)



Fungsi ruang pilih ditetapkan kepada [CHILLED] semasa pembelian. Gunakan panel kawalan seperti berikut.

■ Untuk memilih tetapan suhu [PRIME FRESH]

① Tekan .

• Bahagian tetapan fungsi muncul. (Penunjuk fungsi yang sedang diaktifkan menyala.)

② Tekan .

• Status semasa akan menyala. Apabila  dipaparkan,  tidak akan berfungsi.

③ Tekan  sekali lagi.

• Paparan bertukar kepada  "2". (Tetapan lalai ialah "2".)

④ Tekan  untuk memilih tetapan suhu yang dikehendaki, sama ada "1", "2" atau "3".



• Setiap kali  ditekan, tetapan suhu akan berubah kepada yang seterusnya dan penunjuk tetapan suhu yang dipilih akan menyala.

Setelah selesai, bahagian tetapan fungsi dan suhu akan terpadam kira-kira 10 saat kemudiannya.

■ Untuk melaraskan tetapan suhu peti sejuk atau petak sejuk beku.

① Tekan  sebanyak dua kali untuk memaparkan bahagian tetapan suhu.

• Penunjuk tetapan suhu yang dipilih akan menyala.

② Tekan  atau  dan pilih tetapan suhu yang dikehendaki.



Operasi ECONAVI

■ 3 fungsi ECO mengesan isi padu penyimpanan dan corak kehidupan.

Tenaga dijimatkan secara berkesan dan automatik.*1

Lampu ECONAVI menyala semasa operasi ECONAVI.

ECONAVI beroperasi hanya apabila tetapan suhu adalah "2" pada kedua-dua petak pembeku dan peti sejuk.

Storage Eco

Sensor penyimpanan mengesan perubahan isi padu penyimpanan di petak peti sejuk.

Smart Eco

Bilangan membuka/menutup pintu selama 3 minggu dan perubahan isi padu penyimpanan bagi setiap hari dalam seminggu dan setiap jam disimpan dalam memori, dianalisis dan dianggarkan.

Night Eco

Sensor keamatan cahaya*2 mengesan kecerahan ruang.

- Corak HIDUPKAN/MATIKAN lampu mungkin berubah selepas minggu ke-4 apabila ingatan pola mula berfungsi.
- Kecerahan lampu dikurangkan kira-kira 5 minit selepas lampu menyala. (Lampu boleh dipadamkan jika ia mengganggu anda. Hal. 46)
- Semasa mengesan perubahan isi padu penyimpanan, lampu ECONAVI berkelip perlahan. (Kira-kira 15 saat selepas menutup pintu petak peti sejuk.) Apabila tetapan suhu petak peti sejuk dan petak sejuk beku adalah selain daripada "2", lampu tidak akan berkelip tetapi akan mengesan isi padu penyimpanan.
- Operasi ECONAVI mungkin tidak dilaksanakan bergantung kepada keadaan penggunaan peti sejuk.

*1Keberkesanan berbeza bergantung kepada suhu sekeliling, kecerahan sekeliling, bilangan dan waktu pintu dibuka dan ditutup, dan keadaan makanan yang disimpan.

*2Sensor keamatan cahaya akan berfungsi pada kira-kira 20 luks atau lebih rendah.

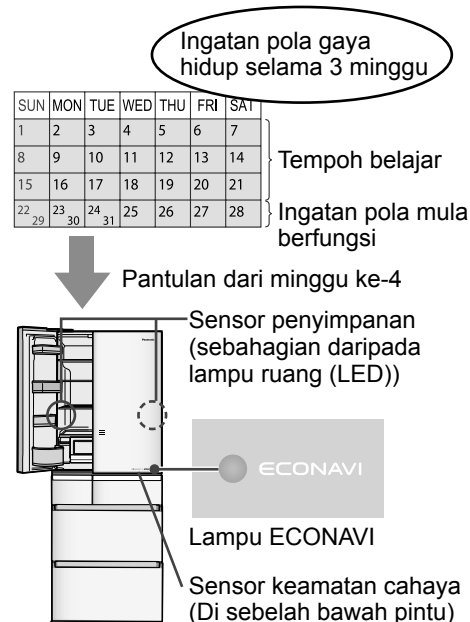

Operasi nanoe™ X

■ nanoe™ ialah partikel ion bersaiz nano yang diselaputi dengan partikel air.

nanoe™ X ialah partikel air atom elektrostatik bersaiz nano dengan 10 kali ganda radikal OH nanoe™.

Mod operasi nanoe™ X bertukar secara automatik tanpa mengira tetapan suhu.

- Kecerahan lampu boleh dilaraskan. (Hal. 47)

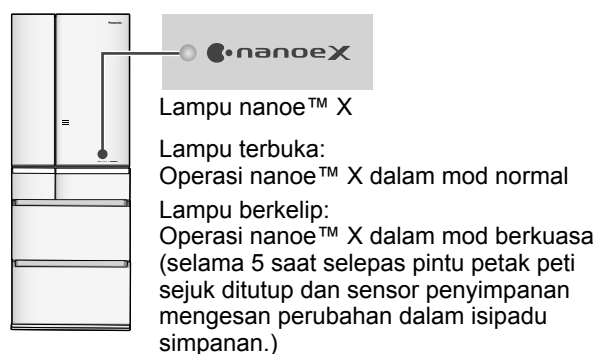

Notis

- Saluran pelepasan nanoe™ X adalah pada bahagian siling petak sayuran.
- nanoe™ X terhasil dengan mengumpulkan kelembapan di udara dan kesannya mungkin berubah.
- Operasi nanoe™ X ditukar kepada mod berkuasa secara automatik apabila sensor penyimpanan mengesan jumlah penyimpanan telah meningkat atau penuh.

Petak Peti Sejuk

Anggaran 3 °C ~ 6 °C

Pembahagi berputar

- Jika pembahagi berputar terbuka ke arah anda, kembalikkannya ke kedudukan asal. (Pintu tidak boleh ditutup dan ia boleh menyebabkan kerosakan.)

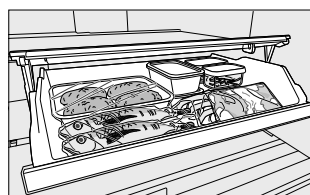
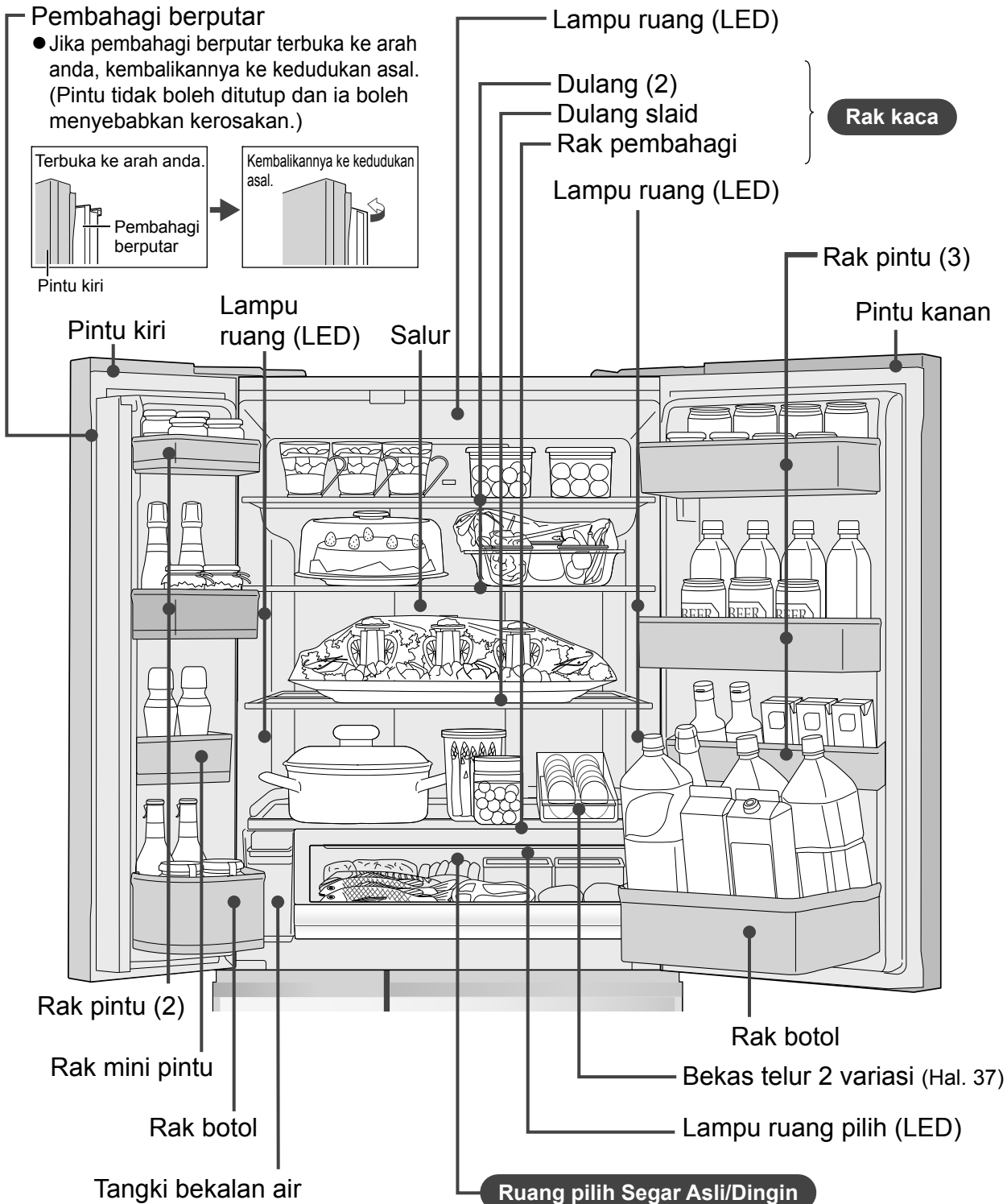
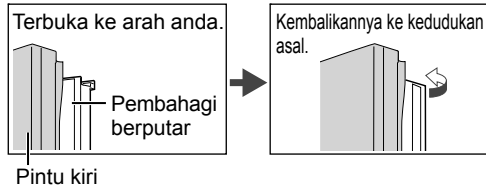

- Zon suhu boleh dipilih sebagai [PRIME FRESH] atau [CHILLED] untuk disesuaikan dengan jenis makanan. (Hal. 38)

Dulang slaid (rak ketiga dari atas)

- Tolak bahagian depan ke arah belakang, anda boleh menyimpan barangan yang bersaiz lebih tinggi di bahagian depan.

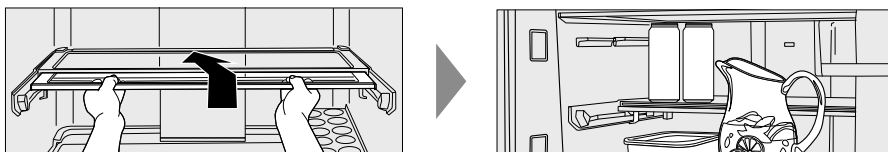

- Anda boleh menyimpan bekas bersaiz besar dengan mudah.

Dulang kaca (hanya rak kedua dari atas)

- ① Angkat sisi belakang dulang dan tarik ke arah anda. Sebaik sahaja tonjolan pada dulang terlepas daripada rel, condongkan dulang dan keluarkannya.
- ② Masukkan dulang pada kedudukan yang dikehendaki dengan menterbalikkan langkah tadi.

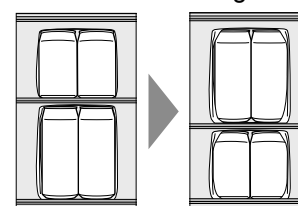
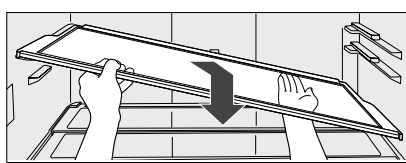
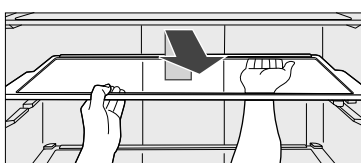

Bekas telur 2 variasi

- Rak telur boleh digunakan dalam 2 cara.

- Apabila menyimpan telur, letakkannya di sebelah kanan rak pembahagi. (Telur mungkin beku jika diletakkan di hadapan saluran udara.) (Hal. 28)

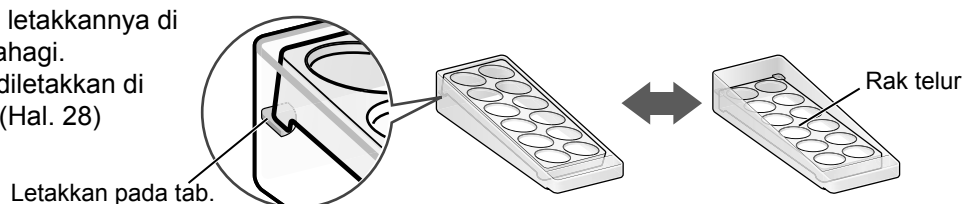

- Condongkan rak telur ke depan bagi memudahkan anda mengambil telur.

“Rak-rak pintu” boleh dipindahkan.

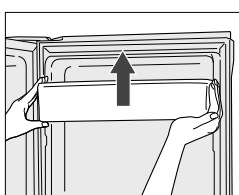

- ① Sambil memegang satu hujung rak dengan sebelah tangan, tolak hujung yang lain dengan perlahan untuk menaikannya.
- ② Memindahkan rak pintu pada kedudukan yang anda gemari.

- Untuk pintu kanan, hanya dulang pertama dari atas.
- Untuk pintu kiri, hanya dulang kedua dari atas.

Permintaan

- Jika sebarang makanan dengan kandungan air yang tinggi diletak di depan lubang udara, ia mungkin disejukkan secara berlebihan atau membeku. (Hal. 28)
(Risiko pecah boleh berlaku terutamanya jika bir dalam tin, minuman bukan alkohol dan soda membeku.)

Simpan makanan berikut di dalam bekas kedap udara atau balut dengan pembalut plastik.

- Bawang hijau atau lain-lain sayuran yang berbau kuat. (→Bau akan merebak ke makanan berdekatan.)
- Hirisan buah limau. (→Plastik akan berubah warna putih.)



Ruang pilih Segar Asli/Dingin

Ruang pilih ditetapkan kepada [CHILLED] semasa pembelian.
Sila tetapkan untuk menyesuaikan tujuan penyimpanan makanan.

Menggunakan sebagai ruang segar asli

Anggaran -3 °C ~ -1 °C

■ Apabila anda ingin memanjangkan jangka hayat makanan dengan membuatnya separa beku.

- Ruang ini sesuai untuk menyimpan makanan segar seperti daging atau ikan.
 - Jika dibandingkan dengan menyimpan di dalam ruang dingin atau petak peti sejuk, jangka hayat penyimpanan daging atau ikan menjadi lebih lama.
 - Suhu boleh ditetapkan kepada " 1 ", " 2 " atau " 3 " untuk disesuaikan dengan isi padu dan jenis makanan. (Hal. 34)
- Tetapan untuk PRIME FRESH " 1 ", " 2 " dan " 3 " menggunakan lebih 10% tenaga berbanding dengan tetapan [CHILLED].

Lampu ruang pilih (LED) sedang menyala dalam warna biru terang



- Apabila makanan terlalu beku.....
Hirisan ikan mentah atau hirisan daging mungkin menjadi terlalu beku.
Tetapkan suhu kepada " 1 " untuk mengelakkan makanan terlebih beku.
- Apabila makanan tidak separa beku.....
Bergantung kepada jenis makanan seperti daging ketul atau ikan besar, keadaan penyimpanan dan suhu sekeliling, makanan mungkin tidak separa beku seperti dikehendaki. Tetapkan suhu kepada " 3 ".

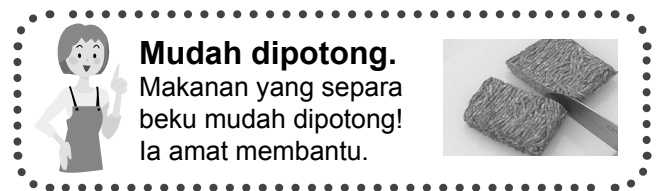

Menggunakan sebagai ruang dingin

Anggaran 0 °C ~ 2 °C

■ Apabila anda tidak mahu membekukan makanan.

- Ruang ini sesuai untuk menyimpan makanan dingin atau produk tenusu.
- Bergantung kepada makanan, ia mungkin dibekukan sebahagian.
Ubah kedudukan makanan atau tetapkan suhu petak peti sejuk kepada " 1 ".

Lampu ruang pilih (LED) sedang menyala dalam warna putih

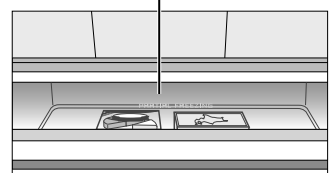

Petua menyimpan

■ Tetapan manakah yang sesuai untuk makanan ini?

<ul style="list-style-type: none"> ● Daging ● Ikan 	➔	PRIME FRESH (SEGAR ASLI)
<ul style="list-style-type: none"> ● Makanan dingin ● Keju ● Krim segar ● Mi rebus 	➔	CHILLED (DINGIN)

■ Apakah makanan itu tidak sesuai untuk Segar Asli/Dingin?

- | | | |
|------------------------------------|---|------------------------|
| ● Telur ● Susu ● Air ● Jus ● Tauhu | ➔ | Dalam petak peti sejuk |
| ● Sayur ● Buah | ➔ | Dalam petak sayuran |
| ● Ais ● Ais krim ● Makanan beku | ➔ | Dalam petak pembeku |

Permintaan

- Apabila anda menukar tetapan suhu, pastikan untuk menggantikan makanan agar sesuai dengan suhu yang ditetapkan.

Menggunakan "QUICK MODE"

Apabila tetapan suhu ruang pilih segar asli/dingin ditetapkan kepada "1", "2" dan "3", Prime Fresh Quick Mode ditetapkan dan beroperasi secara automatik.

■ **Sementara Prime Fresh Quick Mode beroperasi, udara sejuk dikeluarkan lebih daripada biasa dan masa untuk membekukan makanan berkurangan.**

- Ketika menutup penutup bekas, lampu ruang pilih (LED) bertukar daripada biru terang kepada biru, dan Prime Fresh Quick Mode bermula dan berakhir secara automatik. (Lampu ruang pilih menjadi biru muda selepas Prime Fresh Quick Mode tamat.)
- Bergantung pada keadaan penggunaan, Prime Fresh Quick Mode mungkin bermula lewat.
- Ia mungkin mengambil masa yang lebih masa untuk membekukan makanan secara separa bergantung pada jenis makanan, keadaan pembungkusan, jumlah disimpan dan situasi operasi.
- Apabila menyimpan dalam bekas, letakkan makanan anda mengikut ketinggian bekas. (Makanan mungkin terjatuh ke belakang daripada bekas dan penutup mungkin tidak tertutup dengan kemas dan pengesan sensor mungkin tidak berfungsi dengan betul.)
- Sementara Prime Fresh Quick Mode dihidupkan, bunyi menjadi sedikit kuat dan penggunaan tenaga meningkat lebih daripada biasa.

Semasa Prime Fresh Quick Mode lampu ruang pilih (LED) menyala dalam warna biru

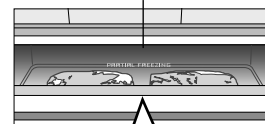

Bungkus makanan di dalam bungkus plastic atau letakkan makanan dalam pek penyimpanan pembeku. Jangan ditindih antara satu sama lain.

Dalam kes ini, masa Prime Fresh Quick Mode mungkin menjadi lebih pendek atau Prime Fresh Quick Mode mungkin tidak bermula.

- Apabila jumlah makanan yang disimpan adalah kecil, atau apabila peti sejuk menganggap Prime Fresh Quick Mode tidak diperlukan kerana suhu makanan sudah cukup rendah.
- Dengan segera selepas Prime Fresh Quick Mode berakhir. (untuk mengelakkan makanan disejukkan terlalu banyak).
- Semasa nyahfros. •Semasa "Fresh Freezing" atau "Quick Ice Making" telah ditetapkan.

Petak Pembekuan Segar

Anggaran -19 °C ~ -17 °C

Menggunakan "FRESH FREEZING"

■ **Bekukan bahan atau makanan dipanaskan seperti nasi panas segera bagi mengekalkan kesegarannya.**

① Tekan .

Bahagian tetapan fungsi muncul. (Penunjuk fungsi yang sedang diaktifkan menyala.)



② Tekan  untuk

menetapkan fungsi Pembekuan Segar. Apabila tetapan selesai,



 dihidupkan.

Semasa Pembekuan Segar sedang beroperasi,

 menyala.

Apabila Pembekuan Segar tamat,  dimatikan.

3 syarat Pembekuan Segar yang lazat

- ① Bungkus makanan dengan ketat.
- ② Pastikan makanan menyentuh plat aluminium.
- ③ Bungkus makanan panas juga.

Plat aluminium

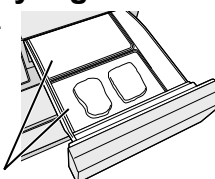

- Bungkus makanan di dalam bungkus plastic atau letakkan di dalam pek penyimpanan pembeku, dan letakkan di plat aluminium.
- Pembekuan Segar tamat secara automatik selepas kira-kira 150 minit.
- Jika anda mahu menghentikan Pembekuan Segar sebelum ia tamat, lakukan langkah yang sama seperti yang diterangkan di sebelah kiri.
- Apabila makanan disimpan untuk tempoh yang lama selepas Pembekuan Segar, simpan makanan di dalam petak pembeku.
- Anda boleh menggunakan petak pembeku semasa Pembekuan Segar tidak beroperasi.
- Simpan ais krim yang mengandungi lebih lemak susu dll. di dalam petak pembeku.
- Jangan memasukkan botol atau tin. (Ia mungkin retak atau pecah.)
- Jangan memasukkan makanan yang lebih tinggi daripada bekas. (Ia akan menghalang pintu ditutup dengan betul, menyebabkan fros.)
- Semasa Pembekuan Segar, penggunaan tenaga meningkat lebih dari biasa.
- Prime Fresh Quick Mode atau ECONAVI tidak beroperasi ketika Fresh Freezing telah ditetapkan.

Petak Ais

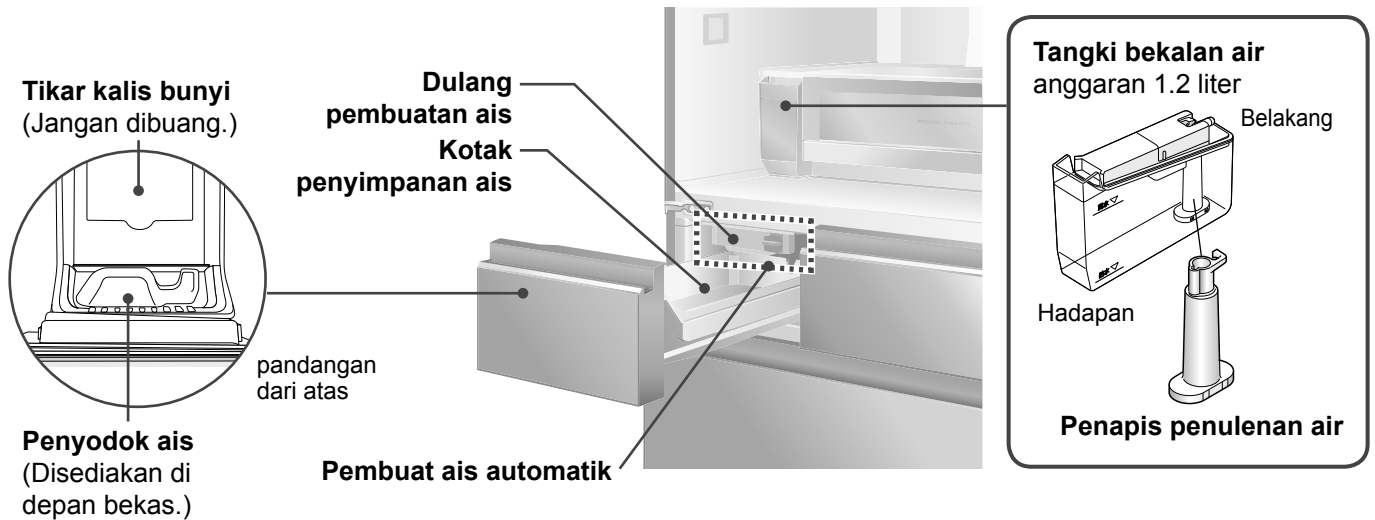

Untuk menggunakan pembuat ais automatik dengan selesa

Hanya gunakan air minuman untuk pembuatan ais auto.

Kerap mencuci tangki bekalan air dan dulang pembuatan ais dengan air. (Hal. 45)

○ Apabila air yang berikut digunakan, cuci tangki bekalan air dengan kerap! (Hal. 45)

Kelikatan air mestilah 100 mg/L atau kurang.



Air minuman



Jangan isi cecair seperti berikut ke dalam tangki bekalan air. (Ia mungkin akan merosakkan petak ais atau menyebabkan kiub ais melekat antara satu sama lain.)



Jus dll.



Minuman sukan



Minuman berkarbonat



Air panas

Permintaan

- Jangan menghempas ketika membuka/menutup pintu petak ais. (Ais boleh jatuh ke bekas petak pembeku atau ke tempat lain.)
- Jangan tuang air terus ke dalam dulang membuat ais untuk buat ais. (Ia boleh menyebabkan kerosakan pada pembuat ais atau kiub ais boleh melekat.)
- Jangan tuang air terus ke dalam kotak penyimpanan ais untuk membuat ais. (Jika tidak, kotak penyimpanan ais mungkin pecah.)
- Kelikatan air mestilah 100 mg/L atau kurang. Mineral mungkin kelihatan seperti zarah putih yang terapung. Ia tidak berbahaya.
- Jangan isi makanan atau item lain ke dalam petak ais. (Jika tidak, jumlah ais tidak dapat dikesan dengan tepat dan pembuatan ais automatik mungkin berhenti atau pintu tidak boleh dibuka.)
- Apabila anda menggunakan petak ais buat kali pertama, anda mungkin akan mendapati terdapat bau atau debu pada dulang pembuatan ais dll. Sila buang ais yang dibuat pada kali pertama.

Notis

Operasi membuat ais auto berhenti secara automatik apabila kotak telah dipenuhi dengan kiub ais. (Operasi tidak berfungsi dengan betul dalam keadaan berikut.)

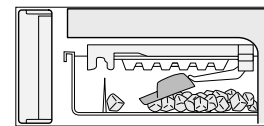

Penyodok ais yang tertinggal dalam kotak penyimpanan ais terkena tuil pengesan ais.

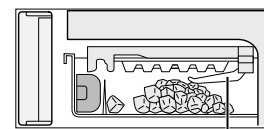

Kiub ais yang menimbun terkena tuil pengesan ais.

Tuil pengesan ais (Apabila ditekan, memberhentikan fungsi membuat ais auto.)

Ia akan mengambil masa yang lebih lama dalam keadaan berikut.

- Apabila peti sejuk digunakan untuk kali pertama. (Ia akan mengambil masa 24 jam atau lebih kerana fungsi pembuatan ais auto akan bermula hanya selepas bahagian dalam cukup sejuk.)
- Apabila pintu kerap dibuka.
- Apabila pintu tidak rapat.
- Apabila banyak makanan disimpan sekaligus.
- Apabila suhu sekeliling rendah pada musim sejuk atau tinggi pada musim panas.
- Apabila kegagalan kuasa berlaku.
- Apabila dulang membuat ais telah dibersihkan. (Hal. 45)

Untuk membuat ais

Ais boleh dibuat dalam kira-kira 2 jam!

①Keluarkan tangki bekalan air.



Tambah air jika parasnya di bawah garisan “給水”. (Gantikan air di dalam tangki bekalan air sekurang-kurangnya sekali seminggu.)

②Isi dengan air.



Tambah air sehingga garisan “満水”. (Fill water up to the '満水' line.)

③Pasangkan tangki bekalan air.



Pegang tangki bekalan air secara mendatar. Sahkan arah tangki dan pasang dengan ketat. (Jika tangki condong, air mungkin tumpah.)

Untuk membuat ais dengan cepat

■ Apabila [QUICK ICE MAKING] ditetapkan, kepantasan membuat ais meningkat.

Ais boleh dibuat dalam masa 80 minit* paling cepat.

- ① Tekan . Bahagian tetapan fungsi muncul. (Penunjuk fungsi yang sedang diaktifkan menyala.)
 - ② Tekan untuk menetapkan fungsi Pembuatan Ais Cepat. Apabila tetapan tamat, dihidupkan. Apabila Pembuatan Ais Cepat sedang beroperasi, menyala. Ketika Pembuatan Ais biasa sedang beroperasi, dimatikan.
- Apabila anda mahu menghentikan pembuatan ais cepat di pertengahan, gunakan panel kawalan seperti yang diterangkan di sebelah kiri. (Penunjuk dimatikan.)
 - Selepas lebih kurang 6 jam, ia kembali ke pembuatan ais auto yang normal.
 - Apabila penyahbekuan dihidupkan, penunjuk akan berkelip. [QUICK ICE MAKING] bermula semula secara automatik bila nyahfros selesai.
 - Semasa pembuatan ais cepat, penggunaan tenaga meningkat lebih dari biasa.
 - Jika [FRESH FREEZING] ditekan semasa [QUICK ICE MAKING], QUICK ICE MAKING dibatalkan.
 - ECONAVI tidak beroperasi ketika QUICK ICE MAKING telah ditetapkan.

*Suhu sekeliling 20 °C, suhu di dalam setiap petak ditetapkan kepada “2”, pintu tidak dibuka atau ditutup.

Untuk menghentikan pembuatan ais auto

■ Hentikan pembuatan ais auto jika anda tidak mahu membuat ais dan sebelum membersihkan dulang pembuatan ais.

- ① Tekan . Bahagian tetapan fungsi muncul. (Penunjuk fungsi yang sedang diaktifkan menyala.)
 - ② Tekan untuk menghentikan pembuatan ais auto. Apabila tetapan selesai, dihidupkan. Semasa AUTO ICE OFF ditetapkan, menyala.
- Gunakan panel kawalan seperti yang diterangkan di atas apabila anda membatalkan AUTO ICE OFF.
 - Anda boleh matikan penunjuk jika ia mengganggu.
- Permintaan
- Terdapat bunyi bip dan kemudian penunjuk akan bertukar daripada berkelip menjadi menyala. Jangan membuka pintu petak ais apabila penunjuk sedang berkelip. (Pembuatan ais tidak boleh dihentikan.)
- Notis
- Apabila anda menghentikan pembuatan ais auto untuk tempoh yang lama, kosongkan tangki bekalan air dan bersihkannya. (Hal. 45)
 - Ais yang sedang dibuat dilepaskan selepas AUTO ICE OFF dibatalkan.

Untuk matikan penunjuk

■ Penunjuk boleh dimatikan semasa pembuatan ais auto dihentikan.

Prosedur Penetapan

Tekan dan secara serentak.



Terdapat bunyi bip, dan selepas beberapa ketika penunjuk dimatikan.

Notis

- Semasa penunjuk dimatikan, buka pintu petak ais dan penunjuk dihidupkan. Penunjuk dimatikan apabila pintu ditutup.

● Untuk batalkan, lakukan seperti di atas.

Petak Pembeku

Anggaran -20 °C ~ -18 °C

① Bekas sejuk beku (Bahagian atas)

Banyak makanan kecil dengan ketebalan boleh disimpan.

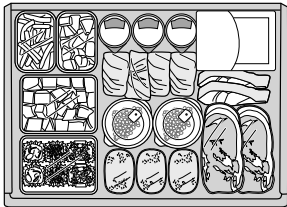

② Bekas sejuk beku (Bahagian bawah)

Makanan yang tinggi boleh disimpan secara menegak.

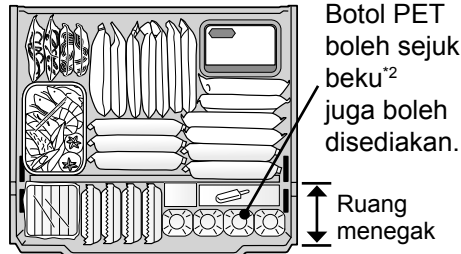

Botol PET boleh sejuk beku^{*2} juga boleh disediakan.

Ruang menegak

*1 NR-F503GT dan NR-F503HX tidak mempunyai bekas sejuk beku bahagian atas.

*2 Jangan letakkan selain daripada botol PET boleh sejuk beku yang dinyatakan oleh pengilang minuman, seperti botol kaca.

Permintaan

- Untuk bekas sejuk beku bahagian atas dan tengah, letakkan makanan anda yang sesuai dengan ketinggian bekas.
- Bagi bekas pembeku sebelah bawah, letakkan makanan di bawah garisan had atas (↓食品はここまで↓) yang ditandakan di sebelah dalam bekas. (Jika tidak, pintu mungkin tidak tertutup rapat dan fros mungkin berlaku.)
- Jangan menyimpan terlalu banyak makanan di dalam ruang menegak.

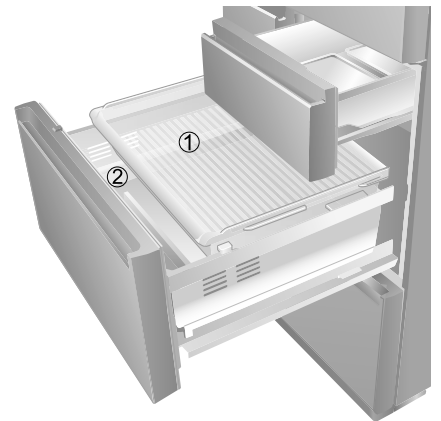

Petak Sayuran

Anggaran 3 °C ~ 8 °C

- Sayuran yang dipotong dan sayuran yang hendak disimpan dalam tempoh yang lama atau dalam jumlah yang sedikit, mungkin perlu dibalut.

① Bekas item sayuran yang kecil (Bahagian atas)

Letakkan tomato dan cili hijau di dalam bekas sayuran kecil.

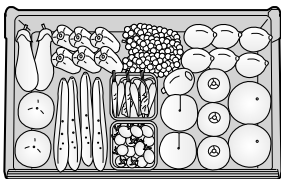

② Bekas sayuran utama (Bahagian bawah)

Simpan sayuran berdaun, bersaiz besar, botol atau nasi di dalam bekas sayuran utama.

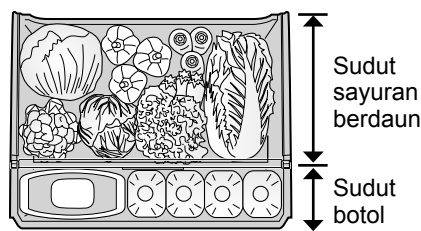

Sudut sayuran berdaun

Sudut botol

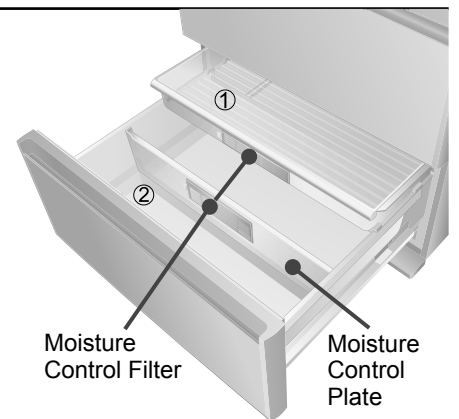

Permintaan

- Tutup nasi dengan rapat sebelum menyimpannya. (Tidak dilengkapi dengan bekas untuk mengawet nasi.)
- Bilangan botol yang boleh disimpan berbeza mengikut model.
- Sayuran mungkin perlu dibalut jika disimpan di sudut botol. Kesan kawalan kelembapan tidak digunakan di sudut botol.

- Kelembapan di dalam petak sayur adalah tinggi dan pemeluwapan boleh berlaku. Cuma lap titisan air.
- Bagi bekas sayuran bersaiz kecil, simpan sayuran anda di bawah garisan had (↑食品はここまで↑) ditandakan di dalam bekas.
- Simpan sayuran dan buah-buahan sesuai dengan ketinggian sudut sayuran berdaun. (Jika tidak, pintu mungkin tidak dapat ditutup dengan baik, pemeluwapan mungkin berlaku, atau sayuran dan buah-buahan mungkin tersepit dan rosak.)

Mencuci, menanggalkan serta memasang semula

Sebelum membersihkan atau menjalankan penyelenggaraan, pastikan anda telah mencabut plag kuasa dari salur keluar dinding.

Jangan memasang atau mencabut plag kuasa jika tangan anda basah. Ini boleh menyebabkan kejutan elektrik atau kecederaan.

Pembersihan

Bersihkan peti sejuk serta merta selepas dikotori.

Lap kotoran mudah tanggal dengan kain yang dicelup dalam air suam.

Cuci kotoran degil menggunakan kain yang direndam dalam detergen neutral cair untuk dapur.

Kemudian lap lebih sabun dengan kain yang dicelup dalam air suam.

Bersihkan bahagian yang tersembunyi sekurang-kurangnya sekali setahun.

Bersihkan debu yang terkumpul pada salur keluar dinding atau permukaan atas dan antara ruang di sekeliling peti sejuk.

Tanggalkan penutup kaki apabila anda melakukan pembersihan. (Hal. 32)

Bagi pelekat pintu, lap dengan kain lembut yang basah, kemudian lap dengan kain kering. (Pelekat yang kotor mudah rosak dan boleh menyebabkan kebocoran udara sejuk.)

Apabila cap jari atau kotoran tidak boleh dibersihkan dengan mudah, lap dengan kain yang direndam sebentar dalam detergen dapur yang neutral dan kemudian lap sekali lagi dengan kain yang basah. Lap semula menggunakan kain yang kering untuk selesaikannya. Pintu diperbuat daripada kaca. Jangan tekan kuat permukaan dan hujung permukaan. (Ini boleh menyebabkan retakan.)

Bahagian sangga untuk pintu petak peti sejuk berputar telah disalut dengan pelincir. Jangan lap bahagian ini. → Jika anda telah mengelapnya, hubungi pengedar anda.

Lap serta-merta! Jika cecair meleleh pada tepi pintu, dengan cepat tepuk dan lap dengan kain kering.

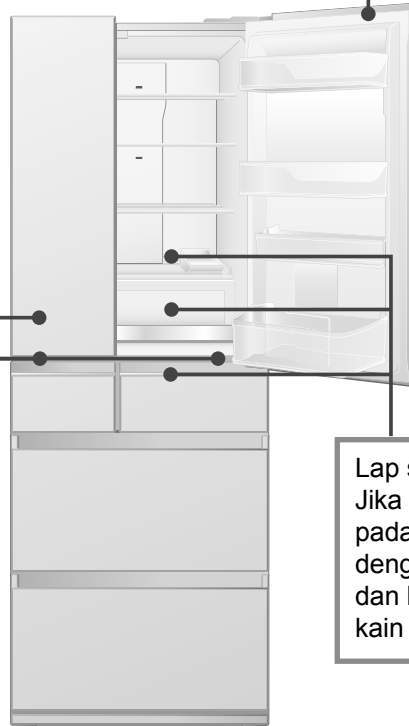

Perhatian

- Perah kain yang basah dengan baik. (Jika air memasuki ruang, ia boleh menyebabkan kerosakan pada bahagian elektrik.)
- Jangan menggunakan mesin pencuci pinggan mangkuk/pengering untuk mencuci bahagian plastik seperti tangki bekalan air dan Dulang pembuatan ais boleh dicuci. (Ini boleh menyebabkan bahagian itu berubah bentuk.)
- Jangan menggunakan bahan berikut untuk mencuci.



Beralkali atau sedikit beralkali

Detergen dapur (selain daripada detergen neutral), Detergen kaca (peluntur klorin) (Ia meretakkan plastik.)



Penyental, Span pengilat



Pencuci, Sabun serbuk



Benzin, Pencair, Alkohol, Asid, Petrol



Air panas

Moisture Control Filter

Apabila kotoran mengganggu anda

Moisture Control Filter ditetapkan dengan cangkuk kepada Moisture Control Plate.

Buang dan bilas dengan air. (Moisture Control Plate tidak boleh dipisahkan.)

Selepas bilas, alirkan air dengan baik. Lap titisan air dan pasang semula.

Untuk kotoran degil, basuh perlahan-lahan dengan sabun dapur cair (neutral) dan berus gigi lembut, dan kemudian bilas sabun.

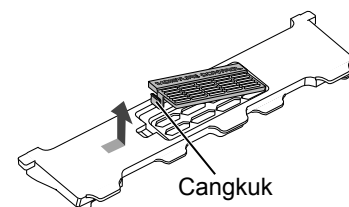

Cangkuk

Perhatian

- Jangan gunakan peluntur dan jangan gosok. (prestasi penapis mungkin merosot.)

Dulang/Dulang slaid (diperbuat daripada kaca)

Sekali setiap 3 bulan

■ **Dulang (Rak atas dalam peti sejuk)**

Lepaskan tonjolan pada cangkuk di belakang dulang dan tarik.

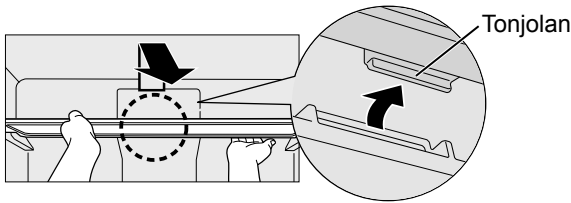

■ **Dulang (rak ke-2 dari atas dalam peti sejuk)**

Angkat sisi belakang dulang dan tarik ke arah anda. Sebaik sahaja tonjolan pada dulang terlepas daripada rel, condongkan dulang dan keluarkannya.

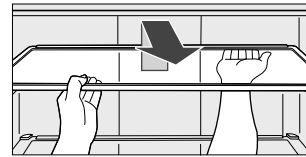

■ **Dulang slaid**

Angkat bahagian depan dan tolak ke dalam, kemudian susun dan angkat tindihan 2 rak.

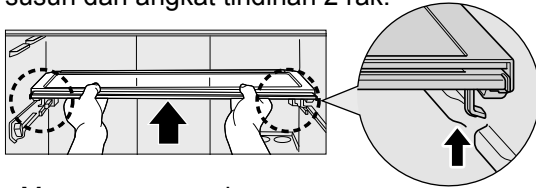

<Memasang semula>

Rendahkan bahagian depan dan tolak ke dalam bersama-sama dengan rel.

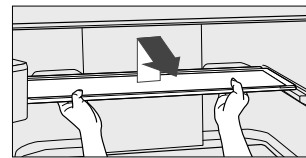

<Memasang semula>

Letakkan tindihan 2 rak di bahagian belakang, kemudian tarik bahagian depan dan tarik ke depan.

Perhatian

- Rak pembahagi tidak boleh dikeluarkan. Semasa pembersihan, lapkan dengan kain yang lembut tanpa mengeluarkannya.
- Dulang, dulang slaid dan rak pembahagi diperbuat daripada kaca dan berat. Berhati-hati semasa memegangnya supaya tidak jatuh dan menyebabkan kerosakan atau kecederaan.
- Apabila pintu tidak boleh dibuka sepenuhnya dan sukar untuk mengeluarkan dulang slaid, tolak bahagian depan ke dalam.

Bekas (Ruang pilih Segar Asli/Dingin)

Sekali setiap 3 bulan

■ **Tanggalkan**

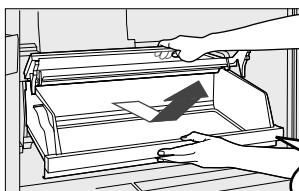

Tarik bekas sejauh yang boleh, angkat bahagian depan dan tarik ia keluar secara condong dengan memegang penutup di atas bekas.

Plat aluminium boleh dikeluarkan.

■ **Memasang semula**

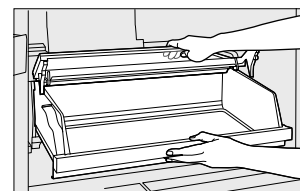

Dengan memegang penutup ke atas, angkat bahagian belakang bekas dan pasangkannya di sepanjang rel di dalam.

Perhatian

- Sila keluarkan rak botol dahulu apabila mengeluarkan bekas. (Jika tidak, rak botol boleh rosak.)
- Keluarkan bekas terlebih dahulu apabila mengeluarkan plat aluminium. Jika plat aluminium dibasuh dengan air, sila tanggalkannya selepas mengeringkan air dan mengelap titisan air yang masih ada di atasnya.
- Bahagian yang terhubung antara bekas dan hujung kanan dan kiri kelepak telah disalut dengan pelincir. Jangan lap pelincir ini. → Hubungi wakil pengedar jika anda mengelapnya.

Rak pintu/Rak botol

Sekali setiap 3 bulan

■ **Tanggalkan**

Tolak bahagian bawah rak pintu ke atas atau tolak bahagian kiri dan kanan rak botol secara berganti-ganti ke atas, dan angkat rak secara perlahan-lahan. (Rak telah dipasang dengan kukuh.)



■ **Memasang semula**

Letakkan setiap rak secara mendatar, dengan tanda [>PS<] di sebelah kanan, dan tekan ke bawah supaya masuk ke tempat asal.

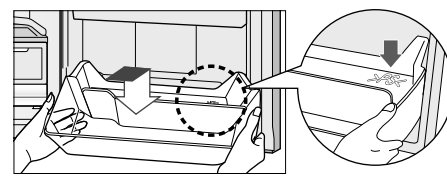

Tangki bekalan air / Penapis penulenan air Sekali seminggu

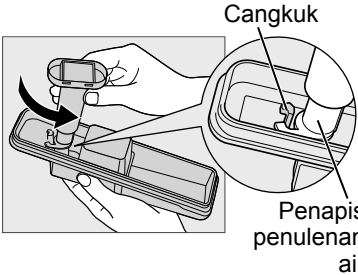
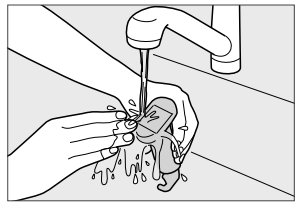
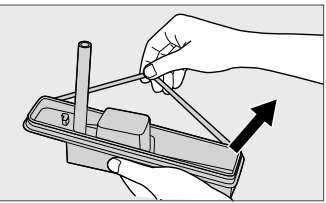
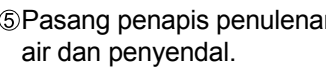
- ① Tanggalkan tudung dan cuci tangki bekalan air dengan air. 
- ② Pusingkan penapis penulenan air untuk menanggalkan dan mengeluarkannya. 
- ③ Cuci penapis penulenan air perlahan-lahan di dalam air. 
- ④ Keluarkan penyendal di sekeliling tepi dari belakang. Cuci ia dengan air. 
- ⑤ Pasang penapis penulenan air dan penyendal. 

- Sebagai panduan, ganti penapis penulenan air setiap tiga tahun. (Bahagian yang dijual berasingan: Hal. 53)
- Jika ada karat air pada penapis penulenan air, ais tidak menjadi dengan betul.

Dulang membuat ais boleh basuh (Di dalam petak ais) Sekali atau dua kali setahun

■ Keluarkan dulang membuat ais dan bilas.

- ① Tekan , kemudian tekan **AUTO ICE OFF** dan hentikan pembuatan ais. (**AUTO ICE OFF** dihidupkan. Hal. 41)
 - ② Putar tombol dalam petak ais kepada kedudukan buka.
 - ③ Tarik tuil ke depan untuk menarik keluar dulang pembuat ais.
 - ④ Cuci ia dengan air. Jangan menggosok permukaan dengan span dll. (Jika dulang membuat ais calar, ia mungkin tidak boleh dikeluarkan dengan betul dan mengakibatkan pincang tugas.)
- Dulang membuat ais dan bingkai tidak boleh dipisahkan.
 - Jangan menggunakan pengering pinggan mangkuk.

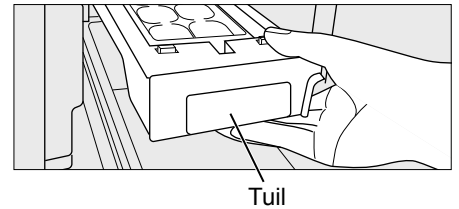
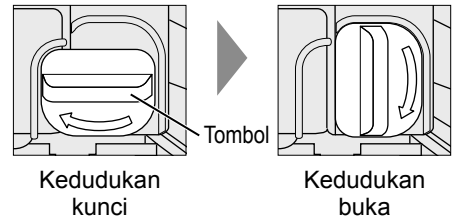

■ Memasang semula

- ① Tolak ke dalam sehingga anda mendengar bunyi klik.
 - ② Putar tombol kepada kedudukan kunci. Ais mungkin tidak dibuat jika dulang pembuat ais tidak dikunci.
 - ③ Tekan , kemudian tekan **AUTO ICE OFF** dan mulakan semula pembuatan ais. (**AUTO ICE OFF** dimatikan. Hal. 41)
- Ais tidak dibuat sehingga [AUTO ICE OFF] dibatalkan.
 - Jangan letakkan air terus ke dalam dulang membuat ais selepas mencuci. (Ia akan menyebabkan kiub ais melekat atau pincang tugas.)

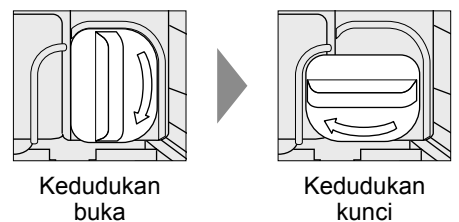

Bekas (Petak Ais/Pembekuan Segar/Pembeku/Sayuran) Sekali setiap 3 bulan



Tarik keluar secara condong

Tarik pintu seluas yang boleh, dan tarik keluar secara condong sambil mengangkat bahagian depan.

Keluarkan plat aluminium

Permintaan

- Bahagian sentuh rel laci telah disalut dengan pelincir. Jangan lap bahagian ini. → Hubungi pengedar anda jika anda telah mengelapnya.
- Apabila bekas atas di dalam petak pembeku atau bekas sayuran kecil telah dikeluarkan, pasang dengan meletakkan “手前 FRONT” yang tertulis di bahagian bawah bekas pada bahagian depan.
- Jangan sentuh plat aluminium dengan tangan basah, contohnya semasa membersihkan plat. (Ia boleh menyebabkan kecederaan sejuk beku.)
- Apabila bekas dan plat aluminium dicuci, pastikan ia betul-betul kering dan mengelap baki titisan air sebelum memasangnya.

Penetapan yang sesuai dengan kehendak anda

Untuk melaras suhu lebih terperinci

■ Suhu petak peti sejuk dan petak pembeku boleh ditetapkan dalam 9 peringkat, lebih terperinci daripada "1", "2" dan "3".

(ECONAVI tidak beroperasi apabila suhu diselaraskan secara terperinci.)



Bagi petak peti sejuk

Prosedur Penetapan

- 1 Tekan  dua kali dan tetapkan suhu peti sejuk kepada tetapan " 1 ".
- 2 Tekan dan tahan **FRIDGE** selama sekurang-kurangnya 10 saat.
(Terdapat bunyi bip dan **2** menyala, kemudian **1** (peringkat 1) menyala selepas 10 saat.)
- 3 Tekan **FRIDGE** dan pilih peringkat pilihan anda.
(Peringkat naik lebih tinggi bagi setiap kali **FRIDGE** ditekan.) Jika **FRIDGE** ditekan apabila peringkat ke-9 ditetapkan (**3** menyala), tetapan kembali kepada " 1 " (**1** menyala).

ECONAVI tidak beroperasi walaupun semasa tetapan suhu adalah " 2 ".

Tetapan	Peringkat	Penunjuk
" 3 "	9	3
	8	2 3
	7	2 3
" 2 "	6	2 3
	5	2
	4	1 2
" 1 "	3	1 2
	2	1 2
	1	1

Status penunjuk
 Menyala  Berkelip

Prosedur Pembatalan

- 1 Tekan  dua kali dan tetapkan suhu peti sejuk kepada tetapan " 1 ".
- 2 Tekan dan tahan **FRIDGE** selama sekurang-kurangnya 10 saat.
(Terdapat bunyi bip, kemudian **1** menyala dan **2** berkelip.)
- 3 Pembatalan tetapan suhu terperinci selesai.
Tetapkan suhu agar sesuai dengan penggunaan biasa anda.

Bagi petak pembeku

Lakukan langkah ① ~ ③ di atas dengan menekan **FREEZER** dan bukan **FRIDGE**.

- Suhu ruang pilih segar asli/dingin tidak boleh dilaraskan secara terperinci.
- Tetapkan ini apabila tiada penunjuk di kawasan penunjuk notis.

Untuk mematikan lampu ECONAVI

■ Lampu ECONAVI boleh dimatikan ketika operasi ECONAVI. (Hal. 35)

(Tetapkan ini apabila tiada penunjuk di kawasan penunjuk notis dan petak pendingin dan petak peti sejuk ditetapkan kepada " 2 ".)

Prosedur Penetapan

Tekan  dua kali, tekan dan tahan **FRIDGE** selama sekurang-kurangnya 3 saat.



Bip berbunyi, lampu ECONAVI berkelip, dan penetapan ini selesai.
(Selepas seketika, lampu ECONAVI padam.)

- Operasi ECONAVI dilakukan meskipun penetapan di atas dibuat.

Prosedur Penetapan

Tekan  dua kali, tekan dan tahan **FRIDGE** selama sekurang-kurangnya 3 saat.





Bip berbunyi, kemudian lampu ECONAVI menyala selama 3 saat dan pembatalan selesai.
(Selepas seketika, lampu ECONAVI padam. Namun, ia akan terus menyala semasa operasi ECONAVI.)

Untuk melaraskan kecerahan lampu nanoe™ X

Kecerahan lampu nanoe™ X boleh dilaraskan. (Hal. 35)
(Anda hanya boleh melaras apabila penunjuk tetapan suhu PRIME FRESH tidak berkelip.)

Prosedur Penetapan

Tekan  dua kali, tekan dan tahan  selama sekurang-kurangnya 10 saat.



Bunyi bip.
Tekan  untuk memilih kecerahan pilihan anda.
Kira-kira 10 saat kemudian, tetapan lengkap.

Tetapan	1	2	3
Kecerahan	OFF	Dim	Bright

(Tetapan "3" pada masa pembelian.)

- Tetapan di atas tidak memberi kesan kepada nanoe™ X.
- Untuk membatalkan, lakukan seperti di atas dan tetapkan kepada "3" (Terang).

Untuk mengunci operasi pada panel kawalan

Ada boleh mengunci panel kawalan supaya tetapan tidak berubah akibat operasi yang tidak disengajakan atau pengoperasian oleh kanak-kanak.

Prosedur Penetapan

Tekan dan tahan  selama sekurang-kurangnya 3 saat.



Bunyi bip kedengaran, "CL" muncul pada penunjuk notis, dan tetapan selesai.
(Selepas beberapa ketika, "CL" hilang di penunjuk notis.)

- Apabila fungsi kunci diaktifkan dan mana-mana kekunci ditekan, "CL" muncul pada penunjuk notis.
- Untuk membuka kunci, lakukan langkah yang sama seperti di atas.

Menyelesaikan masalah

Jika anda berasa bahawa peti sejuk tidak berfungsi dengan betul, periksa perkara berikut terlebih dahulu. Jika masalah berterusan, cabut plag kuasa dan hubungi pengedar anda atau pusat servis yang sah.

Bunyi-bunyi berikut bukan abnormal.

Dari dalam peti sejuk.

- Bunyi gertakan
Bunyi bahagian mengembang dan mengecut akibat perubahan suhu.
- Bunyi pengezuman
Bunyi kipas beroperasi.
- Bunyi berdentingan
Bunyi botol di rak pintu bergetar disebabkan operasi pemampat.

Dari bahagian atas atau belakang.

- Bunyi klik
Bunyi dihasilkan apabila komponen elektrik dan pemampat beroperasi.
- Bunyi pengezuman
Bunyi yang terhasil apabila pemampat beroperasi. Kekuatan bunyi berubah bergantung pada kelajuan putaran pemampat bagi menyesuaikan dengan perubahan suhu.
- Bunyi berkeletakan
Bunyi ini dihasilkan apabila pemampat berhenti.

Dari petak ais dan tangki bekalan air.

- Bunyi deruan, berdesir dan membobok
Bunyi dihasilkan apabila ais dilepaskan oleh pembuat ais automatik dan air dibekalkan.

Apabila pintu petak sejuk beku dibuka.

- Bunyi berdesis
Bunyi air yang disejat oleh pemanas semasa penyahbekuan.
- Bunyi ketukan dan berdebap
Bunyi ini dihasilkan oleh rel laci apabila laci dibuka/ditutup.

Dari bahagian belakang.

- Bunyi menggelobok, berdesis dan mengalir. Bunyi bahan penyejuk (gas) mengalir.

Apabila petak sayuran dibuka.

- Bunyi ketukan dan berdebap
Bunyi dihasilkan dari rel laci apabila laci dibuka/ditutup.

Dari bahagian belakang bawah.

- Bunyi deruan
Bunyi kipas di dalam petak mesin.

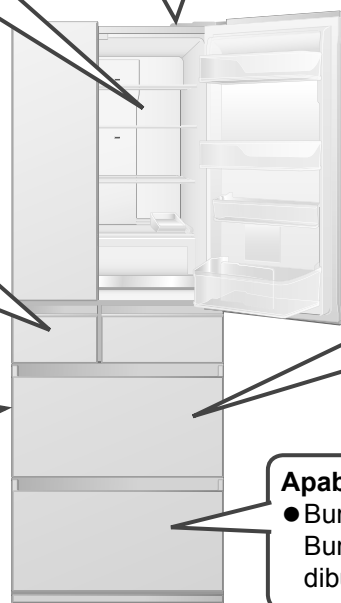

Bunyi	Bunyi berdesir	<ul style="list-style-type: none"> ● Letakkan peti sejuk di atas lantai yang keras dan rata, pastikan kedua-dua kaki boleh larasnya menyentuh lantai dan tetapkan kedudukan peti sejuk. (Hal. 32) ● Adakah bahagian sisi atau belakang peti sejuk atau kord kuasa terkena pada dinding atau perabot di sekitar peti sejuk? → Pastikan peti sejuk tidak menyentuh objek yang berada di sekitarnya.
	Bunyi bising mengganggu saya.	<ul style="list-style-type: none"> ● Pemampat atau kipas boleh menghasilkan bunyi yang kuat apabila peti sejuk menjadi sejuk, seperti apabila peti sejuk masih belum sejuk seurus selepas pemasangan, pintu sering dibuka dan ditutup, suhu di sekeliling peti sejuk tinggi atau Pembekuan Segar ditetapkan kepada ON. Ini bukannya abnormal. → Apabila peti sejuk telah disejukkan, bunyi yang menjadi perlahan.
	Bunyi ketukan	<ul style="list-style-type: none"> ● Apabila lantai tidak rata atau pintu ditutup dengan kuat, peti sejuk akan bergetar dan menghasilkan bunyi. → Letakkan plat di bawah peti sejuk bagi mengelakkannya daripada bergetar. (Hal. 32)
	Terdapat bunyi bising sepanjang masa.	<ul style="list-style-type: none"> ● Ini kerana kelajuan putaran pemampat disesuaikan dengan kawalan penyongsang. (Bunyi bising mungkin tidak akan berhenti tetapi ini bukanlah sesuatu yang tidak normal.)
Badan	Bahagian atas peti sejuk panas.	<ul style="list-style-type: none"> ● Bahagian mekanikal mengalirkan haba. (Hal. 33)
	Panel depan (atau tepi) panas.	<ul style="list-style-type: none"> ● Permukaan tepi kiri dan kanan akan menjadi panas untuk mengeluarkan haba yang dihasilkan ketika sistem pendingin beroperasi. Suhu boleh mencapai 50 °C hingga 60 °C (ketika suhu sekeliling adalah 30 °C) selepas pemasangan atau pada musim panas.
	Permukaan sisi kelihatan meleding.	<ul style="list-style-type: none"> ● Semasa proses pembuatan, permukaan mungkin meleding atau beralun, tetapi ini bukanlah sesuatu yang tidak normal.
Paparan	Tetapan suhu di panel kawalan berkelip.	<ul style="list-style-type: none"> ● Adakah suhu petak peti sejuk atau petak pembeku telah dilaraskan secara terperinci? (Hal. 46) → Apabila suhu ditetapkan secara terperinci, penunjuk akan berkelip. Batalkan tetapan. (Hal. 46)
Pintu	Pintu berat apabila membukanya seurus selepas menutup.	<ul style="list-style-type: none"> ● Udara masuk ke bahagian dalam sejuk secara tiba-tiba. Tekanan dalaman menjadi lebih rendah dari udara luar seketika. Pintu seolah-olah ditarik ke arah dalam.
	Magnet tidak melekat pada pintu.	<ul style="list-style-type: none"> ● Pintu dibuat daripada kaca. Magnet tidak melekat.
Membuat ais	Ais tidak dapat dibuat.	<ul style="list-style-type: none"> ● Apabila anda menggunakan peti sejuk untuk kali pertama, ais akan dibuat selepas bahagian dalam cukup sejuk. (24 jam atau lebih mungkin diperlukan.) ● Pastikan [AUTO ICE OFF] tidak ditetapkan. (Hal. 41) ● Tolak tangki bekalan air sejauh yang mungkin ke arah dalam. Tolak dulang pembuatan ais ke dalam sehingga anda mendengar bunyi klik. (Hal. 41) ● Pastikan bahawa dulang pembuatan ais telah dikunci. (Hal. 45) ● Jangan menyimpan makanan dan lain-lain di dalam kotak penyimpanan ais. (Hal. 40) ● Masok dan keluarkan dulang pembuatan ais hanya apabila perlu. ● Untuk memastikan sama ada pembuat ais berfungsi ataupun tidak, tekan dan tahan [AUTO ICE OFF] selama sekurang-kurangnya 10 saat. Jika air di dalam tangki bekalan air berkurangan, ini bermakna pembuat ais berfungsi. <ul style="list-style-type: none"> • Jika air tertumpah ke dalam kotak penyimpanan ais, lapkannya. • Jika air tidak berkurangan, ini bermakna pembuat ais tidak berfungsi. → Hubungi pengedar anda.
	Bahagian di dalam kiub ais tidak membeku.	<ul style="list-style-type: none"> ● Sudahkan kawalan suhu petak pembeku ditetapkan kepada " 1 " ? → Tetapkan kepada " 2 " atau " 3 ". (Hal. 34)
	Bentuk ais tidak "kubik".	<ul style="list-style-type: none"> ● Terdapat projeksi. → Alur dulang pembuatan ais mungkin telah membeku. ● Kiub ais adalah bulat atau bercantum dengan kiub ais yang lain. → Adakah ais disimpan untuk tempoh yang lama? (Kiub ais menjadi bulat atau bercantum oleh pemejalwapan.) ● Ais kecil. → Kadang-kala, kiub ais bersaiz kecil dihasilkan apabila air di dalam tangki telah habis.

Bau	Ais berbau.	<ul style="list-style-type: none"> ● Bersihkan tangki bekalan air dan penapis penulenan air sekali seminggu. (Hal. 45) ● Jangan gunakan agen pembersih atau peluntur untuk membersihkan tangki bekalan air dan penapis penulenan air. ● Gantikan penapis penulenan air setiap 3 tahun. (Bahagian yang dijual berasingan: Hal. 53)
	Bahagian dalam berbau.	<ul style="list-style-type: none"> ● Simpan makanan yang berbau kuat di dalam bekas kedap udara. ● Bau sering melekat pada dinding bahagian dalam. → Lap dinding dengan kain lembut yang direndam di dalam air suam.
Menyejuk	Tidak sejuk langsung.	<ul style="list-style-type: none"> ● Jika dd dipaparkan di dalam kawasan penunjuk notis panel kawalan, batalkan mod demo. (Hal. 52) ● Pastikan bahawa bekalan elektrik tidak terputus, kord kuasa disambungkan kepada salur keluar atau pemutus tidak berfungsi.
	Tidak cukup sejuk.	<ul style="list-style-type: none"> ● Apabila anda menggunakan peti sejuk buat kali pertama, ia akan mengambil masa 4 hingga 24 jam atau lebih (semasa musim panas, dll.) sehingga peti sejuk mula menyejuk. ● Tukar tetapan suhu kepada tetapan yang lebih sejuk. (Hal. 34) ● Pastikan bahawa makanan tidak menghalang salur keluar udara sejuk. (Hal. 28) ● Jangan letakkan peti sejuk di tempat yang terdedah kepada pancaran terus matahari. (Hal. 32) ● Pastikan ada ruang yang mencukupi di sekitar peti sejuk. (Hal. 32) ● Peti sejuk mungkin mengambil masa yang lebih lama untuk menyejuk jika terlalu banyak makanan disimpan di dalamnya atau "Fresh Freezing" digunakan untuk tempoh yang lama.
	Fros dan embun	<ul style="list-style-type: none"> ● Jangan biarkan pintu terbuka untuk tempoh yang lama atau dibuka terlalu kerap apabila kelembapan adalah tinggi. ● Apabila aksesori yang dibeli di kedai seperti pintu tersekat pada pintu, keluarkannya. ● Jika makanan terjatuh di bahagian belakang dari bekas di dalam petak sejuk beku atau petak sayuran, pintu tidak dapat ditutup dengan baik. Keluarkan makanan tersebut. ● Fros atau embun mungkin terbentuk pada permukaan luar peti sejuk apabila kelembapan adalah tinggi. → Cuma lap dengan kain kering.
	Makanan membeku.	<ul style="list-style-type: none"> ● Tetapkan tetapan suhu kepada "2" (atau "1"). (Hal. 34) ● Adakah suhu sekeliling 5 °C atau kurang? → Tetapkan tetapan suhu kepada "1". (Hal. 34) ● Jangan letakkan makanan yang mempunyai kandungan air yang tinggi berhampiran dengan salur keluar udara sejuk di dalam peti sejuk (Hal. 28) atau di dalam ruang pilih segar asli/dingin.
Prime Fresh	Prime Fresh Quick Mode berhenti dengan cepat, atau berhenti semasa beroperasi.	<ul style="list-style-type: none"> ● Dalam keadaan berikut, tempoh untuk mod cepat mungkin menjadi lebih pendek (ia kembali ke operasi Prime Fresh daripada mod cepat dengan pantas). • Sebaik sahaja selepas mod cepat tamat. • Apabila peti sejuk memutuskan bahawa mod cepat adalah tidak perlu berdasarkan pada jumlah makanan atau suhu. • Semasa penyahbekuan. • Apabila suhu petak peti sejuk atau petak sejuk beku adalah tinggi. ● Bergantung pada keadaan penggunaan, mod cepat mungkin berhenti dan bermula semula selepas suhu di dalam petak menjadi stabil.

Dalam kes-kes sebegini?

Kegagalan kuasa.	<ul style="list-style-type: none"> ● Biarkan pintu tertutup dan jangan simpan makanan tambahan. ● [FRESH FREEZING] dan [QUICK ICE MAKING] berhenti. Tetapkan fungsi ini sekali lagi selepas kuasa disambung semula.
Plag kuasa telah tercabut.	<ul style="list-style-type: none"> ● Tunggu sekurang-kurangnya 7 minit, kemudian pasang plag kuasa. (Jika plag dipasang serta-merta, pemampat akan terlebih beban, yang boleh menyebabkan pincang tugas.)
Peti sejuk tidak digunakan untuk waktu yang lama.	<ul style="list-style-type: none"> ● Keluarkan semua makanan dan minuman dan bersihkan peti sejuk. <ol style="list-style-type: none"> ① Cabut plag kuasa. ② Bersihkan petak dan dulang membuat ais. (Hal. 43 ~ Hal. 45) ③ Biarkan pintu terbuka selama 2 hingga 3 hari untuk mengeringkan petak. (Bila pengeringan tidak mencukupi, petak mungkin hapak atau berbau busuk.)
Lampu ruang tidak menyala.	→ Hubungi pengedar anda. (Apabila lampu ruang berkelip, lihat Hal. 52.)
Kaca telah pecah. (Dulang • pintu kaca)	<ul style="list-style-type: none"> ● Apabila dulang kaca atau pintu kaca telah pecah, jangan sentuh kaca yang pecah dan hubungi segera pengedar anda yang sah atau pusat servis.
Memindahkan peti sejuk.	<ul style="list-style-type: none"> ● Untuk mengelakkan permukaan lantai daripada rosak, letakkan papan pelindung atau yang seumpamanya. <ol style="list-style-type: none"> ① Cabut plag kuasa. ② Keluarkan penutup kaki, kemudian naikkan kaki boleh laras. (Hal. 32) ③ Gerakkan peti sejuk ke depan atau belakang. ④ Selepas berpindah, tetapkan peti sejuk sepenuhnya dengan kaki boleh laras. Pasangkan semula penutup kaki. (Hal. 32)
Apabila anda memindah atau mengangkut peti sejuk.	<ul style="list-style-type: none"> ● Angkat peti sejuk dengan sekurang-kurangnya 2 orang. Jangan mengangkatnya dalam kedudukan mendatar. (Ini boleh menyebabkan kecederaan atau kerosakan pada peti sejuk.) <ol style="list-style-type: none"> ① Keluarkan makanan dan minuman dan buang air di dalam tangki bekalan air. ② Hentikan fungsi membuat ais auto. (Hal. 41) ③ Bersihkan dulang membuat ais. (Hal. 45) ④ Cabut plag kuasa. ⑤ Tanggalkan skru penutup kaki pada kaki boleh laras. (Hal. 32) (Tanggalkan penutup kaki sebelum mengangkut peti sejuk.) ⑥ Letakkan vesel di bawah lubang saliran. (yang tingginya adalah 2 cm atau kurang). ⑦ Condongkan peti sejuk ke belakang untuk mengalirkan air dari lubang saliran. (Untuk mengelakkan air keluar, condongkan peti sejuk ke belakang secara perlahan-lahan.) ⑧ Letakkan lapisan pelindung atau yang seumpamanya dan gerakkan peti sejuk. (Kerana mungkin masih terdapat air di bahagian dalam.)



Letakkan bekas dan kain. (Air mungkin mengalir dalam kuantiti yang banyak.)

Perhatian

- Jika fros masih ada pada unit penyejukan (tidak terlihat dari luar) di dalam peti sejuk, air mungkin tumpah apabila ia dipindahkan. (Ia mengambil sekitar 15 jam untuk fros di dalam unit penyejukan menjadi cair selepas plag kuasa peti ais dicabut.)

Pembuat ais automatik tidak digunakan untuk waktu yang lama.

● Berhenti membuat ais, dengan tangki bekalan air kosong dan bersihkan pembuat ais.

① Buang air di dalam tangki bekalan air.

② Tekan , kemudian tekan **AUTO ICE OFF** dan hentikan pembuatan ais. (Hal. 41)

(**AUTO ICE OFF** dihidupkan.)

③ Buang ais yang disimpan di dalam dulang membuat ais dan kotak penyimpanan ais.

- Apabila ais disimpan terlalu lama, kiub ais menjadi bulat atau bercantum oleh pemejalwapan.

④ Bilas kotak penyimpanan ais, penyodok ais dan tangki bekalan air. Lap air dan kembalikan kepada kedudukan asal.

- Keringkan penapis penulenan air dengan sempurna. (Penapis penulenan air mempunyai kelembapan. Jika ia tidak dikeringkan dengan sempurna, kulapuk atau bau mungkin akan terhasil.)

→ Apabila mula menggunakan pembuat ais automatik sekali lagi, batalkan "AUTO ICE OFF". (Hal. 41)

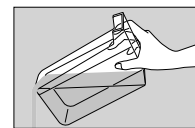

Jika bunyi atau penunjuk yang berikut dihasilkan

Penggera menghasilkan bunyi bip dan lampu ruang (LED) berkelip, dan huruf "U" serta angka "10" ditunjukkan berselang-seli pada kawasan penunjuk notis.



Pintu petak peti sejuk, petak ais atau petak pembeku terbuka.

Tutup pintu yang terbuka.

	Penggera	Lampu ruang (LED)
1 minit kemudian	Bip dua kali	Berkelip sekali
3 minit kemudian	2 bip dua kali	Berkelip dua kali
5 minit kemudian	Bip dua kali berterusan	Berkelip 3 kali
Lebih daripada 5 minit kemudian	Bip dua kali berterusan	Berkelip 3 kali setiap 2 minit selepas itu

- Selepas 5 minit, lampu ECONAVI dan nanoe™ X akan berkelip secara serentak.

Huruf "H" dan satu nombor bergilir-gilir ditunjukkan di kawasan penunjuk notis.

"Contoh"



Keabnormalan mungkin telah berlaku.

Jika penunjuk muncul, hubungi wakil pengedar anda.

"dd" dipaparkan di kawasan penunjuk notis. Lampu ruang berkelip.



Peti sejuk dalam mod demo.

- Operasi penyejukan dihentikan.

Batalkan mod demo.

- ① Buka petak ais dan pintu petak sejuk beku.
- ② Tekan  dua kali untuk menunjukkan bahagian tetapan suhu.
- ③ Buka pintu petak peti sejuk.
- ④ Tekan dan tahan **FREEZER** selama sekurang-kurangnya 10 saat. (Bunyi bip dan **dd** akan hilang. Mod demo dibatalkan.)
- ⑤ Tutup pintu petak peti sejuk, petak sejuk beku dan petak ais.

Spesifikasi

MODEL	NR-F503GT-T7
JUMLAH ISI PADU KASAR	528 L
JUMLAH ISI PADU PENYIMPANAN	402 L
ISI PADU PENYIMPANAN PETI SEJUK	250 L
ISI PADU PENYIMPANAN AIS	4 L
ISI PADU PENYIMPANAN PEMBEKUAN SEGAR	14 L
ISI PADU PENYIMPANAN PEMBEKU	63 L
ISI PADU PENYIMPANAN SAYURAN	71 L
DIMENSI LUARAN LEBAR×KEDALAMAN×TINGGI	650 mm × 699 mm × 1828 mm
BERAT	105 kg / 231 lb
KADAR VOLTAN KADAR FREKUENSI	Ditunjukkan pada label penunjuk kualiti di bahagian dalam pintu petak peti sejuk.

- Isi padu peti sejuk ini adalah berdasarkan IEC 62552.

Bahagian yang dijual berasingan

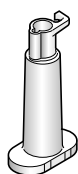

Penapis penulenan air untuk tangki bekalan air (Hal.45)
ARMH00B00820

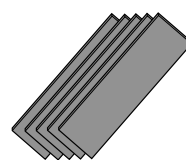

Set plat pelarasan (Hal. 32)
CNR79-338120

目錄

簡介	安全須知	55
安裝	安裝	58
	選擇正確的位置	58
操作	所有功能使用	59
	溫度設定和指南	59
	操作面板	60
	如何操作	60
	ECONAVI 運作模式	61
	nanoe™ X 運作模式	61
	冷藏室	62
	微凍結／冰溫選擇室	64
	新鮮凍結室	65
	製冰室	66
	急凍室	68
	蔬果室	68
附錄	清洗、取出並重新安裝	69
	清理	69
	依據自己偏好設置	72
	故障排除	74
	在這些情況下？	77
	如果出現以下聲音或現象	78
	規格	79
	另售零件	79

- 該產品主要適用於家用電器及其相關應用，例如
 - 商店、辦公室和其他工作環境的員工食堂；
 - 農舍和住有旅客的酒店、旅館以及其他居住環境；
 - 放置床和吃早餐的環境；
 - 餐飲和相關非零售應用。

■ 為了節約能源

- 不要把食物塞滿夾層裡。
否則可能阻礙冷氣進入。食物之間要保持足夠的空隙。
- 僅在需要的時候才打開門。
降低門開／關的次數阻止冷氣溢出並且降低耗電量。
- 不要讓食品阻塞冷氣出口。
如果冷氣不能擴散到夾層的各個角落，內部就不能達到冷藏效果而且會消耗更多的電量。
- 冷氣從後面的排放管中排放出去。
- 在食物和飲料冷卻後進行儲存。
否則，它們不僅會提高內部的溫度，而且會影響其他食品的保鮮。

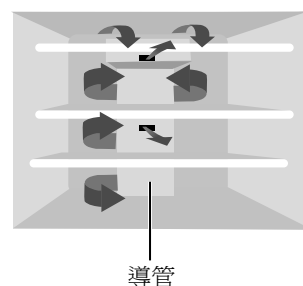

■ 處理包裝袋







請盡可能回收可再利用的物料（例如紙板、塑膠袋、膠帶和泡沫）並且確保你穩妥地處理了其他包裝材料。

包裝袋應該放置在兒童不能觸及的位置避免兒童受到傷害或導致窒息。

安全須知

安全標誌含義

 請勿	 請務必遵守	 表示該設備必須接地，以防觸電
 請勿拆開	 警告；可燃 / 易燃材料的風險	

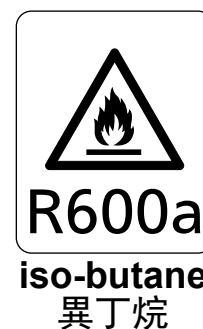

表示有死亡或嚴重傷害的風險。



- 警告：除生產商推薦的設備外，否則不得使用機械設備或其他設備加速除霜過程。
- 警告：不得損壞製冷劑回路。
(否則，可燃性製冷劑可能會著火並引起爆炸。)
- 警告：切勿在本設備的食品儲藏室內使用電器，除非該類電器是由製造商推薦的類型。
(如果製冷劑洩漏，可能會因對接點火花而引起火災。)
- 切勿在本設備中儲存爆炸性物品，如備有易燃壓縮氣體的噴霧罐。
- 警告：不要在設備後部放置多個便攜式插座或便攜式電源。



- 除非有負責其安全的人員指導和監督，否則兒童、身體行動不便或缺乏經驗和常識的人不得使用該設備。不容許小孩以雪櫃做遊戲。
- 如果設備的電源線或插頭損壞，必須由製造商或其服務代理商或具有類似資格的人員進行更換，以避免發生危險。
- 警告：只裝飲用水。
- 警告：確保雪櫃外殼或內置結構的通風口無阻塞。
- 警告：安放設備時，請確保電源線沒有被卡住或損壞。

關於電源插頭和電線……



- 不要用延長電線。
- 不要用濕手插拔電源插頭。
- 不得損壞電源插頭或電線。不要切斷或處理插頭或電線；不得將插頭或電線暴露於高溫下；不得過分彎折、扭曲或拉扯插頭或電線；不得在插頭或電線上放置重物；不得將插頭或電線成束排列。
→ 聯繫經銷商修理插座或電線。
- 不得將雪櫃後部對著電源插座。
- 禁止使用損壞的電線或電源插頭或沒有完全插入插座的插頭。



- 定期清理電源插頭上的污垢，如灰塵。
- 將電源插頭插入自身帶額定電壓和額定電流的牆上插座中，並完全插入。
- 斷開電源插頭時，請握住插頭本身，不要握住電源線。
- 清潔雪櫃前，請拔下插頭。
- 當雪櫃長時間不用，請拔下電源插頭。
(否則，會引起火災或觸電。)

如果出現異常或故障，應立即停止使用雪櫃並拔出插頭。
(否則，可能會引起煙霧、火災或觸電。)



- 異常和故障舉例
- 電源線或插座異常熱
 - 電源線有深的切口或明顯變形
 - 有燒焦氣味
 - 你可以強烈地感覺到電流
- 立即聯繫經銷商進行檢查和修理。

雪櫃頂部……



- 不得放置任何東西。
否則，可能會因為振動而掉落並造成人身傷害。
- 不得在頂蓋上放置任何東西。
(否則，部件可能會變形，引起觸電。)



使用……



- 不得吊在或依靠在門上。
 - 雪櫃外殼或內部不得用水。
(否則，電絕緣劣化並可能引起觸電或火災。)
 - 請勿觸摸製冰盒上的機制裝置。
 - 當製冰功能開啟時，不得移動製冰盒。
 - 不得在雪櫃中儲存可燃物品。
 - 不得儲存化學物品或科學標本。
 - 在雪櫃附近，切勿使用易燃化學物品。
 - 不得對玻璃門施加高衝擊力。
(否則，玻璃可能會破裂並造成傷害。)
- 如發現玻璃上出現裂縫，不要觸摸玻璃，請立即諮詢經銷商。



- 應照看好兒童以確保雪櫃正確使用。

安裝……



- 不得將雪櫃安裝在碰到水的位置。
- 不得在雪櫃周圍空隙填塞其他物品。
(如製冷劑洩漏，可能會引起火災。)



- 提供防止因地震等原因導致的翻倒的安全措施。



- 確保雪櫃插頭接入接地電源插座。
不得插入未接地電源插座。(3 腳插頭)

雪櫃的處置和回收……



- 當回收雪櫃時，拆下雪櫃門封，以防有小童擅自藏身櫃內，發生意外。
- 可燃氣體用於製冷劑。
以及環戊烷用於雪櫃保溫。
廢棄雪櫃時，請以妥善的方法加以丟棄。
- 在雪櫃的整個使用壽命期間，需保持上述警告標誌完好無損。
在將雪櫃運輸至另一地點以或交付給回收廠時，這些使用說明書應移交至會使用或處理雪櫃的人。

緊急情況……



- 請勿打開頂蓋和後蓋。
- 請勿拆卸、修理或改裝雪櫃。
(否則, 會造成人身傷害、燒傷或觸電。)



- 如果發現氣體(如城市煤氣)洩漏, 請勿碰觸雪櫃, 並打開窗戶使廚房通風。
- 該雪櫃的製冷劑為易燃。如果冷卻回路(管道)損壞, 請打開窗戶使廚房通風並與經銷商聯繫。
- 維修工作必須由受過良好培訓的維修專業人員在車間進行維修。
(否則, 可能會引起電擊、著火或爆炸。)



注意

表示有人身傷害或財產損失風險。

儲存食物……



- 不得對玻璃置物架施加高衝擊力。
(否則, 玻璃置物架可能會損壞, 你可能會受傷。)
- 不得使食物從玻璃擱架中突出出來。
- 如果食品容器不能達到擱架底部, 請勿將其放在門架上。
(否則, 食物可能會掉落並造成人身傷害。)
- 不得冷凍瓶子。
(如果玻璃瓶中的液體凍結, 瓶子可能會破損, 你可能會受傷。)
- 切勿用濕手觸摸冰凍的食品或容器(特別是金屬容器)和鋁板。
(否則, 你可能會凍傷手。)
- 切勿吃已變質或變色的食物。
(腐爛食物可能會引發疾病。)

開 / 關雪櫃門……



- 當其他人在接觸到雪櫃時不得開 / 關雪櫃門。
- 開 / 關門時, 切勿將手指放在冷藏室縫處。
- 切勿握住抽屜上部開 / 關製冰室和新鮮凍結室。
- 切勿將腳放在底層抽屜下。
(否則, 可能會夾住你的腳趾。)
- 切勿過度用力開 / 關雪櫃門。
(否則, 食物可能會掉落並造成人身傷害。)



清潔……



- 切勿直接觸碰金屬軌。
- 請勿將手或腳放入雪櫃底部下方。
(金屬板邊緣可能會造成人身傷害。)



- 安裝或取下玻璃擱架時, 請小心。
(掉落的玻璃擱架可能會導致玻璃擱架損壞或由於玻璃擱架損壞而導致人身傷害。)

移動或搬運雪櫃……



- 將配有可調校的雪櫃腳的雪櫃安裝在平坦堅實的地板上。
(否則, 雪櫃可能會移動或傾倒, 造成人身傷害。)
- 為脆弱的地板表面鋪上防護層等。
- 當運送雪櫃時, 請使用把手並由至少兩位工作人員搬運。
(否則, 你的手可能會打滑並導致受傷。)



安裝

選擇正確的位置

1. 雪櫃放置環境。

- 遠離熱源並避免陽光直射以盡可能減少製冷能力並防止電力浪費。
- 濕度較低的良好通風位置以免生鏽或冷凝。
- 堅實平坦的地板
當放置於鋪有地毯、榻榻米墊子或乙烯基地板上時，請在雪櫃下面鋪墊結實的墊板以防止地毯變形或變色。
- 將雪櫃遠離其他設備放置以防止噪音干擾和不正確的圖像顯示在電視和其他設備上。
- 放置於便於清潔電源插座的地方。
定期清潔灰塵。
(以免引起火災。)

- 散熱良好的位置
振動噪音、牆壁變色或背面冷凝對你造成干擾時，將雪櫃放置在距離牆壁 30 毫米或更遠處。

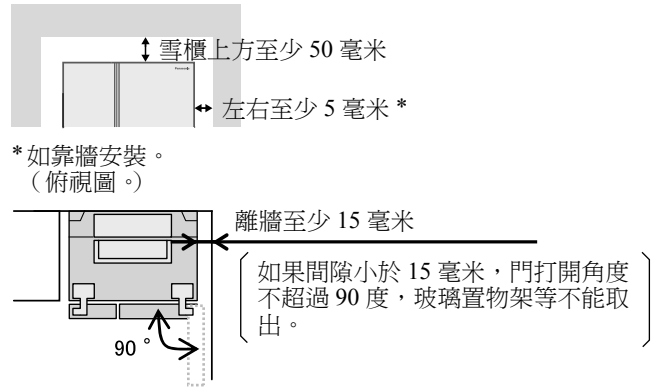

■ 首次使用雪櫃前 (第 69 頁 ~ 第 71 頁)

- 請使用濕的軟布擦拭雪櫃內部。
- 請沖洗儲水器、淨水過濾器 and 製冰盒。

2. 雪櫃安裝。

- 如果雪櫃安放不平穩，開 / 關雪櫃門時會出現敲擊聲。
(這會影響雪櫃的工作性能。)
將雪櫃安裝在堅實平坦的地板上。
- 檢查冷藏室的左門和右門是否平行。若不平行，則使用可調校的雪櫃腳的專用工具調節門的水平。
- 由於安裝地點或所使用地板的傾斜角度，雪櫃門可能會降低。
- 在購買時，腳蓋上配有用於調校可調校的雪櫃腳的專用工具。
使用後，你可以將其存放在腳蓋的後面。

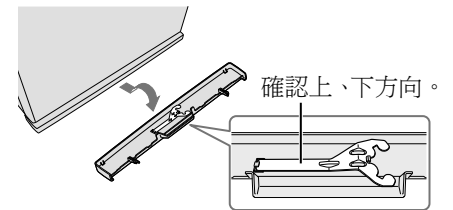

- ① 拆下腳蓋。
雙手插入腳蓋兩側上的“▼”下方，將其拉出。

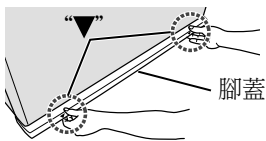

- ③ 若門已降低，則用專用工具轉動可調校的雪櫃腳並調整水平使得門變為平行狀態。

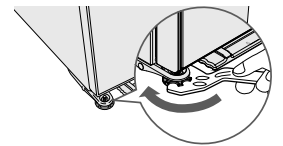

- ② 旋轉可調校的雪櫃腳 (右和左)，使雪櫃保持平穩。

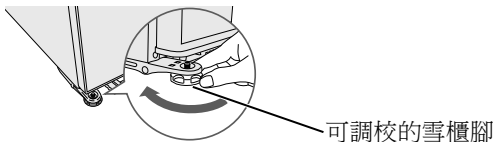

- ④ 重新安上腳蓋。

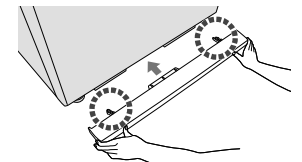

■ 雪櫃門向下傾斜

旋轉較低側的可調校的雪櫃腳以調整平穩，如右圖所示。

- 在安裝後 4 到 5 天內急凍室 / 冷藏室門可能由於裝入食物或適應地面而傾斜。在這種情況下，重新調整可調校的雪櫃腳以調節平穩。
- 如果透過此方法不能解決，則使用板調節墊板。
(另售零件：第 79 頁)

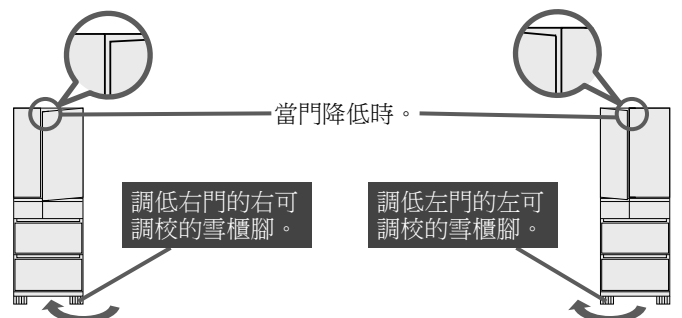

3. 插頭插入壁裝電源插座。

將插頭插入與其相配的額定電壓和電流的壁裝電源插座。

- 安裝後電源插頭可以立即插入插座。
- 當接通電源時，雪櫃周圍及表面（側面）可能會非常熱（當環境溫度為 30°C，其溫度約 50°C 至 60°C），這是正常現象。（第 75 頁）
- 拔掉電源插頭後，至少保持間隔 7 分鐘，才能再次插電。（第 77 頁）
- 如果雪櫃沒有接地線插頭，應將其與接地裝置連接以防止因電洩漏而觸電。

為安全起見，雪櫃應進行接地連接

（帶有不接地 2 腳插頭的雪櫃）

進行接地連接是以防觸電。

請使用以下兩種方式的任意一種進行接地連接：

1. 當使用帶接地插孔的插座時，將接地線與插座和雪櫃背面的接地線螺絲相連（請見 ⊕ 標誌），如圖示 ①。
2. 當使用未帶接地插孔的插座時，將接地線連接到雪櫃後方的螺絲上（請見 ⊕ 標誌），然後將另一端連接到接地棒，如圖所示 ②。

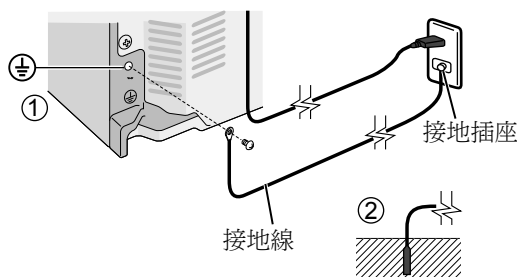

切勿使用以下器件進行接地連接

- 煤氣管道和供水管道（有觸電或爆炸危險）
- 電話線和避雷針的接地線（有雷擊風險）

4. 雪櫃內部冷卻。

- 內部冷卻大約需要 4 個小時。
- 夏天雪櫃內部均勻冷卻需要 24 個小時或更長時間。
- 雪櫃內部完全冷卻後，方可製冰。
- 雪櫃內部完全冷卻前，切勿開 / 關雪櫃門。（暖空氣流會進入內部阻礙冷卻功能。）

須知事項

- 請勿將物品放置於雪櫃頂部。雪櫃頂部的壓縮器運行產熱，也會使其變熱。如果熱量難以釋放，可能會降低雪櫃的冷卻能力。



壓縮器

備註

- 在安裝後，噪音變大，這是因為雪櫃內部還沒有降溫，壓縮器或風機以高速旋轉運行，但是這種現象是正常的。（雪櫃內部冷卻後，噪音會變小。）

所有功能使用

溫度設定和指南

溫度設定	CHILLED	1	2	3
FRIDGE		約比“2”高 2°C ~ 3°C	約為 3°C ~ 6°C	約比“2”低 2°C ~ 3°C
FREEZER		約比“2”高 2°C ~ 3°C	約為 -20°C ~ -18°C	約比“2”低 2°C ~ 3°C
PRIME FRESH	約為 0°C ~ 2°C	約比“2”高 1°C ~ 2°C	約為 -3°C ~ -1°C	約比“2”低 1°C ~ 2°C

（這些只是在環境溫度為 32°C，雪櫃中沒有存放食品且內部溫度已經穩定的情況下的粗略指示說明。由於環境溫度、食物儲存狀態、門開關次數以及其他使用情況的不同，該溫度可能會不同。）

所有功能使用

操作面板

通常，功能設置部分以及溫度設置部分不可見。

按下  一次顯示功能設置部分。

按下  兩次顯示溫度設置部分。

按下  3 次隱藏功能和溫度設置部分。

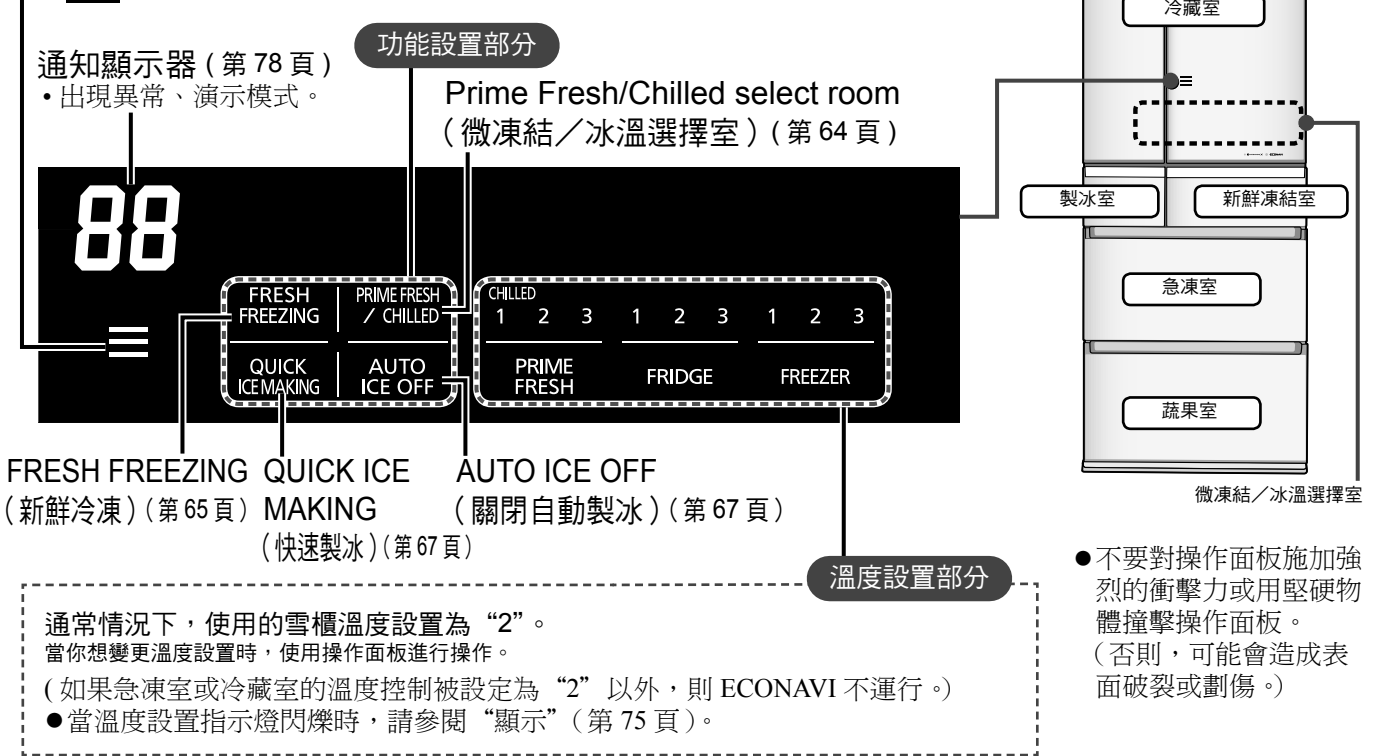





●不要對操作面板施加強烈的衝擊力或用堅硬物體撞擊操作面板。(否則，可能會造成表面破裂或劃傷。)

- 只有在冷藏室門關閉時才可變更設置。
- 當“CL”出現在通知顯示器中時，操作鎖定功能被激活。(第 73 頁)

如何操作 (示例：使用選擇室作為微凍結室)

在購買時選擇室被設定為 [CHILLED]。按如下程序操作操作面板。

■ 選擇 [PRIME FRESH] 的溫度設置

- ① 按下 。
 - 功能設置部分出現。(當前激活的功能顯示器亮起。)
- ② 按下 。
 - 當前狀態亮起。當顯示 **CHILLED** 時，**PRIME FRESH** 不運行。
- ③ 再次按下 。
 - 顯示變為 **PRIME FRESH** “2”。(默認設置為 “2”。)
- ④ 按下  選擇想要的溫度設置 “1”、“2” 或 “3”。
 - 每一次按下  都將切換到下一個溫度設置，所選擇的溫度設置顯示器被點亮。



當完成操作時，功能和溫度設置部分將在大約 10 秒後消失。

■ 調整冷藏室或急凍室的溫度設置。

- ① 按下  兩次顯示溫度設置部分。
 - 當前選定的溫度設置的顯示器被點亮。
- ② 按下 **FRIDGE** 或 **FREEZER** 並調校到想要的溫度設置。

ECONAVI 運作模式

- 3 個 ECO 功能檢測儲存容量和生活模式。
可有效自動節省能量。*1

在 ECONAVI 運作模式運行過程中，ECONAVI 燈號亮。
只有當冷凍室和冷藏室的溫度設置為“2”時，ECONAVI 才會運作。

- 儲存 Eco** 儲存感應器檢測冷藏室內的儲存容量變化。
- 智能 Eco** 3 周開 / 關門次數、每天或每小時儲存容量變化的記憶、分析和評價。
- 夜間 Eco** 光照強度感應器 *2 檢測環境亮度。

- ECONAVI 燈號的開 / 關模式可能會在第 4 個星期後發生變化，在這期間，學習內容開始起作用。
- 在燈亮起約為 5 分鐘後，亮度減弱。(如果你不喜歡，可以關閉該指示燈。第 72 頁)
- 在檢測儲存容量變化的過程，ECONAVI 燈號會緩慢閃爍。(關閉冷藏室門後約 15 秒鐘。)
當冷藏室和急凍室的溫度設定在“2”以外時，ECONAVI 燈號不閃爍，但是感應器會檢測儲存量。
- 雪櫃的使用狀態決定是否執行 ECONAVI 運作模式。

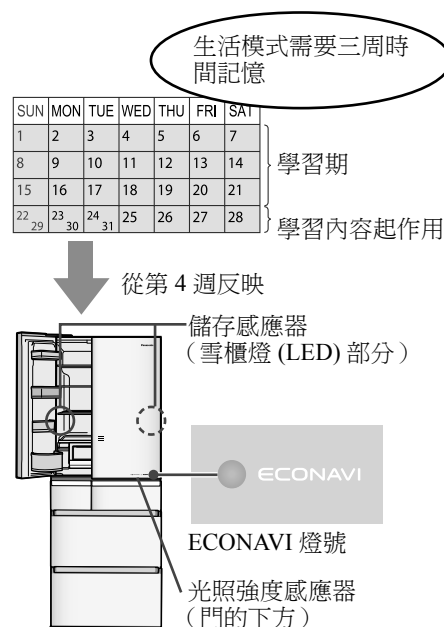

*1 效果因環境溫度、環境亮度、門打開和關閉的次數以及食物儲存的狀態而異。
*2 光照強度感應器在大約 20 勒克斯或以下時運行。

nanoe™ X 運作模式

- nanoe™ X 是塗有水粒子的納米級離子顆粒。
nanoe™ X 是納米級別的靜電霧化水顆粒，OH 自由基含量是 nanoe™ 的 10 倍。
nanoe™ X 運作模式將無視溫度設置自動切換。

- 指示燈的亮度可以調校。(第 73 頁)

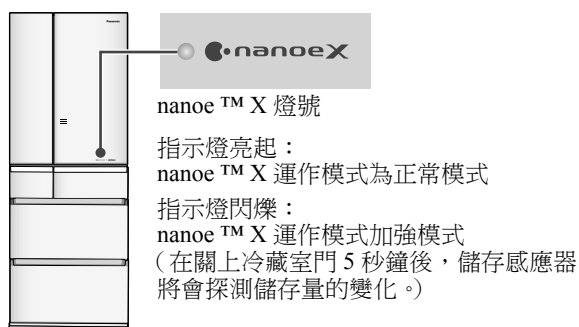

備註

- nanoe™ X 的排放口位於蔬果室的天花。
- nanoe™ X 透過收集空氣中的水份而產生，且效果可能會改變。
- 當儲存感應器探測到儲存量增加或存量已滿時，nanoe™ X 的操作模式將會自動切換至加強模式。

冷藏室

約為 3°C ~ 6°C

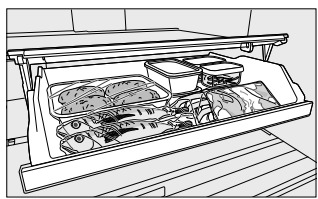
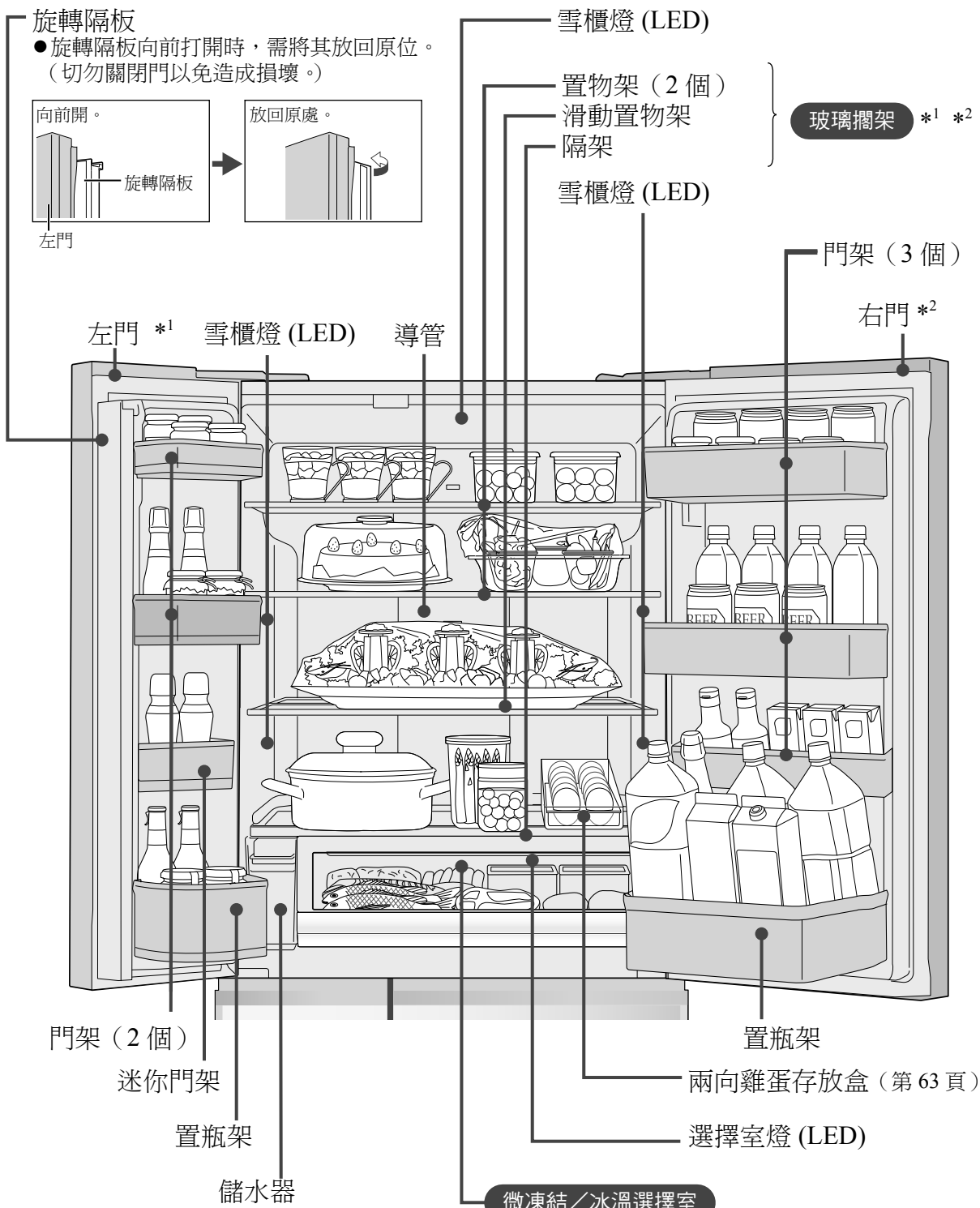

●溫度區可以選擇 [PRIME FRESH] 或 [CHILLED] 以適應食物類型。
(第 64 頁)

●NR-F603GT 插圖用於說明。

*1 玻璃置物架以及 NR-F654GT/NR-F654HX 的右門與 NR-F603GT 不同。

*2 玻璃置物架以及 NR-F503GT/NR-F503HX 的右門與 NR-F603GT 不同。

滑動置物架（從上開始第三個架子）

■ 向後滑動前半部，可以將較高的物品放在前面。

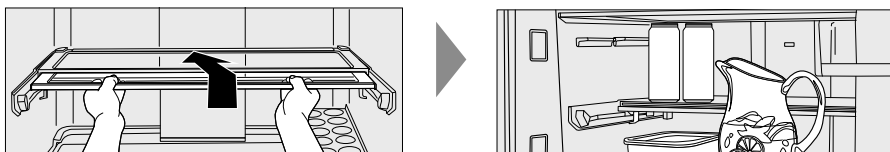

● 你可以輕鬆放置大的罐子。

玻璃置物架（只有頂部的第二個架子）

① 向上托起置物架後部朝前拉。
置物架的突起脫離軌後，將置物架傾斜著取出。

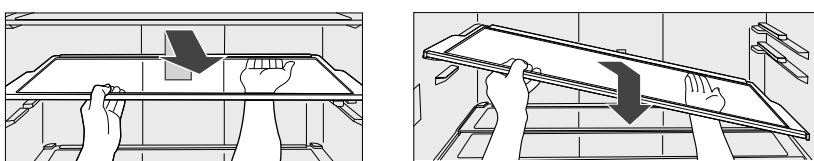

② 以上述方式相反的方式便可將置物架推入到所需位置。

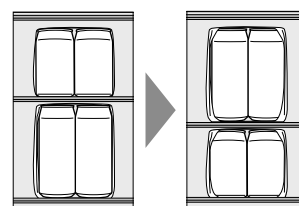

兩向雞蛋存放盒

■ 雞蛋架可以採用兩種安裝方式。

- 儲存雞蛋時，將其放置在隔架的右側。
(若將其置放於出風口前，雞蛋可能會被凍結。)(第 54 頁)

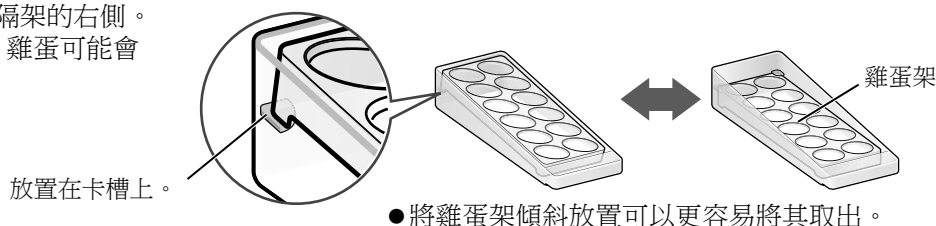

放置在卡槽上。

● 將雞蛋架傾斜放置可以更容易將其取出。

“門架”可以移動。

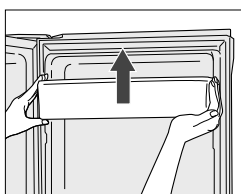

- ① 用一隻手握住擱架的一端，另一隻手輕輕敲擊擱架另一端便可抬起擱架。
- ② 移動門架到你喜歡的位置。

- 對右側門，只能移動頂部第一個擱架。
- 對左側門，只能移動頂部第二個擱架。

須知事項

- 放在出風口前的任何高水分食品可能會過度冷卻或凍結。(第 54 頁)
(特別是當蘇打水凍結時，存在爆炸的風險。)

將以下食物放入密封的容器中或用保鮮紙包裝。

- 大蔥或其他強烈氣味的蔬菜。
(→ 異味會竄到其他附近的食物上。)
- 鮮切柑橘類水果。
(→ 塑膠會變白。)



微凍結／冰溫選擇室

購買時選擇室設置為 [CHILLED] 模式。
請根據食品的不同預期使用目的進行設置。

用作微凍結室

約為 -3°C ~ -1°C

■ 當你想要延長微凍食品的保存期限時。

- 該室適用於儲存新鮮食品，比如肉或魚。
 - 與儲存在冰溫室或冷藏室相比，肉或魚的保存期限會更長。
 - 溫度可以設定為“1”、“2”或“3”，以適應不同類型或不同量的食品。(第 60 頁)
- 微凍結“1”、“2”、“3”的設定要比 [CHILLED] 設定消耗多於 10% 的能量。

選擇室燈 (LED) 亮起淺藍色燈光

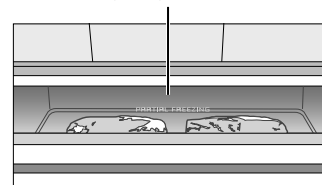

- 食品過度凍結
生魚片或肉片可能會過度凍結。
將溫度設定為“1”，以防止食物過度冷凍。
- 食品不是微凍
由於食品類型（如肉塊或大魚）、貯藏條件和環境溫度不同，可能食物並沒有微凍。設定溫度為“3”。

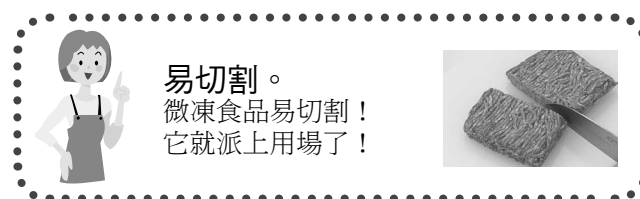

用作冰溫室

約為 0°C ~ 2°C

■ 當你不想凍結食品時。

- 該室適於儲存冷藏食品或乳製品。
- 根據食物不同，可能會部分凍結。
改變食品位置或將冷藏室溫度設定為“1”。

選擇室燈 (LED) 亮起白色燈光

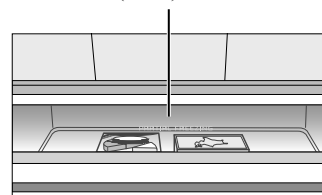

儲存小貼士

■ 哪些設置適合這些食物？

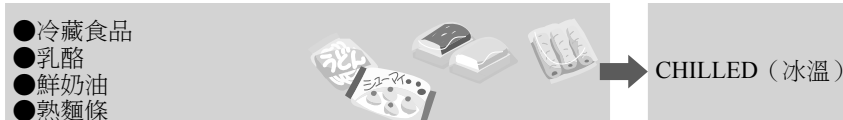

■ 什麼食品不適用微凍結 / 冷凍？

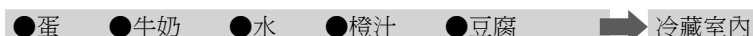

須知事項

- 當改變溫度設定時，確保更換適合該設定溫度的食品。

使用“QUICK MODE”

當微凍結/冰溫選擇室的溫度設定為“1”，“2”及“3”時，Prime Fresh Quick Mode 已被設定且會自動操作。

- 當以 Prime Fresh Quick Mode 模式運作時，將比平時排放更多冷空氣，而非徹底冷凍食物所需時間亦被縮短。
- 當關上儲存盒檔板時，選擇室燈 (LED) 會從淺藍色變成藍色燈光，Prime Fresh Quick Mode 將啟動並自動結束。
(當 Prime Fresh Quick Mode 結束後，選擇室燈變為淺藍色。)
- 根據使用狀態，Prime Fresh Quick Mode 可能會在開始時有延遲。
- 冷凍部份食物可能需時較長，具體視食品種類、包裝條件、儲存量和運行情況而定。
- 當在儲存盒中存放食物時，請放入低於儲存盒高度之食物。
(食物可能會從儲存盒的背面掉落，擋板亦可能未關妥，這樣可能令感應器未能正確地工作。)
- 當 Prime Fresh Quick Mode 啟用時，聲音將稍微變大，而能源消耗亦會比平常增加。

在 Prime Fresh Quick Mode 期間，選擇室燈 (LED) 亮起藍色燈光

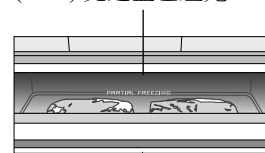

使用保鮮紙包裝食物，或將其放入冷凍儲存包內。切勿將食物堆疊在彼此的頂部。

在這種情況下，Prime Fresh Quick Mode 的運行時間可能變短或可能不會開啟 Prime Fresh Quick Mode。

- 當食物儲存量少，或因食物溫度已夠低，雪櫃系統判定不需要啟用 Prime Fresh Quick Mode 時。
- 在 Prime Fresh Quick Mode 完結後立即進行。(避免食物過凍)。
- 除霜期間。
- 當已設置“Fresh Freezing”或“Quick Ice Making”時。

新鮮凍結室

約為 -19 °C ~ -17°C

使用“FRESH FREEZING”

■ 立即冷凍原料或加熱食品(如熱飯)以保持新鮮度。

- ① 按下 。
功能設置部分出現。
(當前激活的功能顯示器亮起。)



- ② 按下 設定
Fresh Freezing 功能。
設定完成時， 開啟。



- 當 Fresh Freezing 運行時， 亮起。
當 Fresh Freezing 結束時， 關閉。

- 用保鮮膜包裹食品或將其放在冷凍儲存包中，並將其放置在鋁板上。
- 在大約 150 分鐘後新鮮冷凍自動停止。
- 當你想在中途停止 Fresh Freezing 時，請按照左側所述的步驟進行相同操作。
- 當新鮮冷凍後的食品需要長時間儲存時，請將其儲存在急凍室裏。
- 當新鮮凍結室不工作時，你可以使用急凍室。
- 將高乳脂的冰淇淋等儲存在急凍室中。
- 不要放置瓶或罐。(它們可能會破裂或爆炸。)
- 不要儲存高於該盒的食品。(這可能造成門無法正常關閉，進而導致霜凍。)
- 在新鮮冷凍期間，能源消耗比平常多。
- 當已設置 Fresh Freezing 時，Prime Fresh Quick Mode 或 ECONAVI 將不會運行。

美味新鮮冷凍的 3 個步驟

- ① 緊緊包裹食品。
- ② 使食物與鋁板緊密接觸。
- ③ 熱食也要包裹。

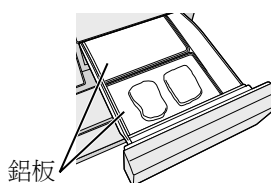

製冰室

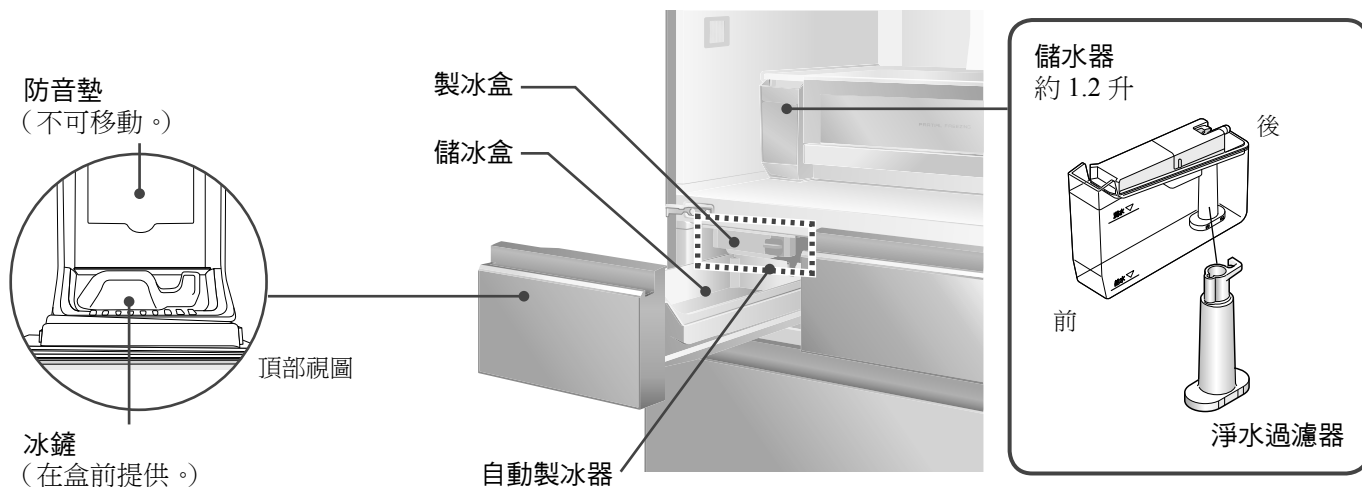

舒適地使用自動製冰器

自動製冰，請使用飲用水。

用水經常清洗儲水器和製冰盒。(第 71 頁)

○ 當使用以下水時，要經常沖洗儲水器！
(第 71 頁)

水質硬度必須為
100 毫克 / 升或更低。



飲用水



儲水器中不得存放以下液體。
(這些液體可能會損壞製冰室或引起冰塊互相粘接。)



橙汁等



運動飲料



碳酸飲料



熱水

須知事項

- 切勿猛開或猛關製冰室。
(冰可能會掉落到雪櫃急凍室或其他地方。)
- 切勿將水直接倒入製冰盒中製冰。
(這也許會損壞製冰機或冰塊會粘在一起。)
- 切勿將水直接倒入儲冰盒製冰。
(否則，可能會損壞儲冰盒。)
- 水質硬度必須為 100 毫克 / 升或更低。
礦物質可能會出現白色漂浮顆粒。它們對人體沒有害。
- 不要將食物或其他食品放入製冰室。
(否則，將無法正確檢測製冰量，並且自動製冰可能會停止，或門無法打開。)
- 當首次使用製冰室時，製冰盒等可能有異味和灰塵。
請丟棄第一批冰塊。

備註

當儲冰盒裝滿冰塊時，自動製冰操作會自動停止。
(該操作在以下情況下無法正常工作。)

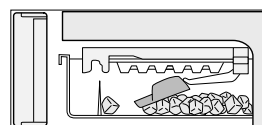

留在儲冰盒中的冰鏟撞擊到冰塊感應槓杆。

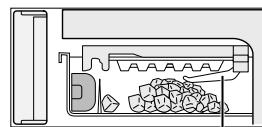

冰塊堆過高觸碰到冰塊感應槓杆。

冰塊感應槓杆
(按下冰塊感應槓杆，自動製冰功能停止。)

以下情況將需要更長時間。

- 首次使用雪櫃。
(可能需要 24 小時或者更長時間，因為只有在雪櫃內部溫度足夠低時自動製冰功能才會啟動。)
- 經常開門。
- 門半開。
- 同時儲存大量食品。
- 冬天室溫過低或夏天室溫過高。
- 出現電源故障。
- 可洗製冰盒已經被清洗。(第 71 頁)

製冰約需兩個小時！

製冰

①取出儲水器。

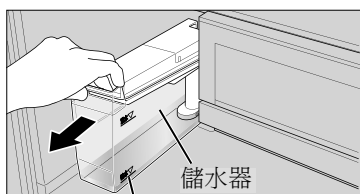

如果儲水器水位在“給水”線下，要向儲水器中加水。
(至少每週更換一次儲水器水。)

②加滿水。



加水至“滿水”線。

③安裝儲水器。



水平地握住儲水器。確認儲水器的方向並牢固安裝。
(如果儲水器傾斜，水將可能灑出來)

快速製冰

■在設置 [QUICK ICE MAKING] 時，製冰速度增加。
最快可以在 80 分鐘內完成製冰*。

①按下 。

功能設置部分出現。
(當前激活的功能顯示器亮起。)

②按下 設定 Quick Ice Making 功能。

當設定完成時， 開啟。

當 Quick Ice Making 正在運行時， 亮起。

當常用的製冰正在運行時， 關閉。

*室溫 20°C、每室溫度設置為“2”，關閉門。

- 當你想要中途停止快速製冰時，如左所述操作操作面板。
(顯示器關閉。)
- 在大約 6 個小時後，回到正常的製冰模式。
- 當除霜開啟時，顯示器閃爍。
除霜完成，[QUICK ICE MAKING] 自動重新啟動。
- 在快速製冰過程中，能量消耗比平常多。
- [QUICK ICE MAKING] 期間，按下 [FRESH FREEZING]，即可取消 QUICK ICE MAKING。
- QUICK ICE MAKING 設置後，ECONAVI 不工作。

自動製冰停止

■如果不想製冰，並且在清潔製冰盒之前，請停止自動製冰。

①按下 。

功能設置部分出現。(當前激活的功能顯示器亮起。)

②按下 停止自動製冰。

當設定完成時， 開啟。

當設定 AUTO ICE OFF 時， 亮起。

- 當取消 AUTO ICE OFF 時，如上所述操作操作面板。
- 如果顯示器對你造成干擾，可以關掉。

須知事項

- 會發出蜂鳴聲，然後顯示器從閃爍變為常亮。不要在顯示器閃爍時打開製冰室門。(製冰不能停止。)



備註

- 當長時間不自動製冰時，清空並清洗儲水器。(第 71 頁)
- 在取消 AUTO ICE OFF 後，所制的冰釋放出來。

關閉顯示器

■當自動製冰停止時，可以關閉顯示器 。

設置步驟

同時按下  和 。  發出蜂鳴聲，一段時間過後顯示器  關閉。

- 如需取消，按如上所述操作。

備註

- 當顯示器  熄滅時，打開製冰室門，顯示器開啟。當關門時，顯示器關閉。

急凍室

約為 -20 °C ~ -18 °C

① 急凍室容器 (上部) *1

一小塊食物可能不會丟失。

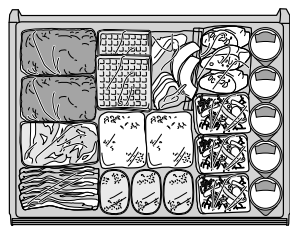

• 抬起把手並將容器向後滑動。

② 急凍室容器 (中間)

可以儲存較厚的小塊食物。

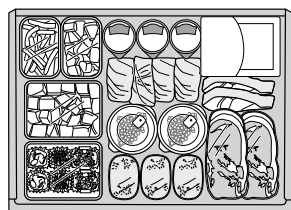

③ 急凍室容器 (下部)

高的食物可以垂直放置。

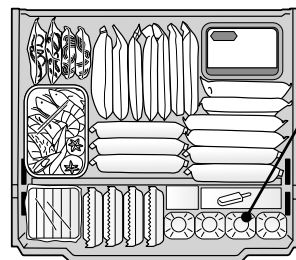

還可以放置兩瓶可凍結的 PET 瓶罐 *2。

垂直空間

*1 NR-F503GT 和 NR-F503HX 沒有上部的急凍室容器。

*2 不要放入飲料製造商指定的可凍結 PET 瓶罐以外的其他瓶罐，例如玻璃瓶。

須知事項

- 對於急凍室的上部和中間容器，放入的食物高度應在容器高度範圍內。
- 對於急凍室容器下部，食品放置應在最高上限以下 (↓食品はここまで↓)。(否則，門可能無法完全關閉，會出現結霜)
- 不要把食物塞進垂直空間。

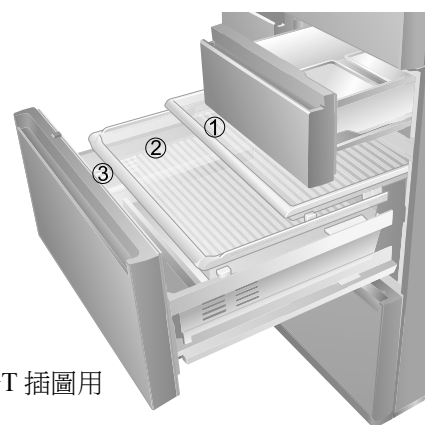

• NR-F603GT 插圖用於說明。

蔬果室

約為 3 °C ~ 8 °C

- 切好的蔬菜，需要儲存較長時間或少量蔬菜時需要包裝。

① 小型蔬果盒 (上部)

將番茄和青椒放在小型蔬果盒中。

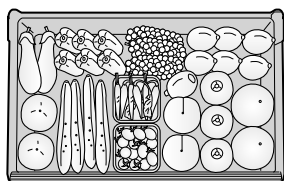

② 蔬果室容器 (下部)

將綠葉蔬菜、較大的蔬菜、瓶罐或大米放入蔬果室容器。

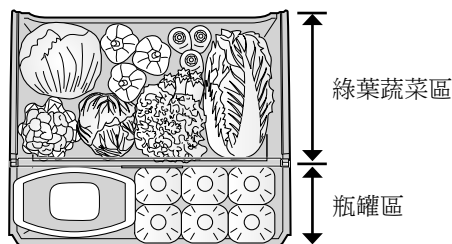

綠葉蔬菜區

瓶罐區

③ 瓶罐支架 *

瓶罐支架的位置可變更。

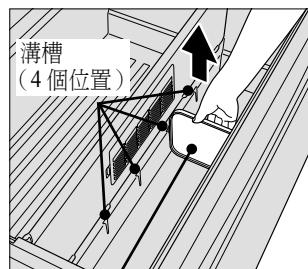

豎直向上拉動瓶罐支架，並將其放在所需的位置！

* NR-F503GT 和 NR-F503HX 沒有瓶罐支架。

• NR-F603GT 插圖用於說明。

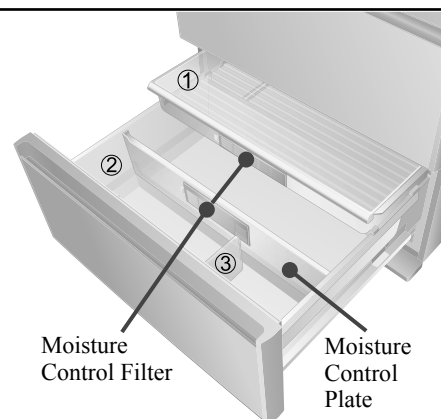

Moisture Control Filter

Moisture Control Plate

須知事項

- 蔬果室濕度過高，可能會出現冷凝。只需擦去水珠。
- 對於小型蔬果盒，蔬菜放置應在最高上限以下 (↑食品はここまで↑)。
- 放入的蔬果高度應在綠葉蔬菜區的高度以內。(否則，門可能無法完全關閉，可能會出現冷凝，或者蔬果可能會卡住或受損。)

清洗、取出並重新安裝

清理或維護前，務必將電源插頭從插座中拔出。
切勿用濕手插拔電源插頭。否則，可能引起觸電或受傷。

清理

請及時清潔骯髒雪櫃。

用一塊布蘸點溫水可以很容易地清除污漬。
使用浸泡在稀釋的廚房中性洗滌劑中的布擦去頑固污漬。

然後再用蘸有溫水的布清洗殘留洗滌劑。

至少每年清潔一次隱藏區域。

清除積聚在牆壁插座上或在雪櫃頂和雪櫃周圍縫隙中的灰塵。

清潔時請取下腳蓋。(第 58 頁)

對於雪櫃門封清潔，首先使用一塊濕布擦拭，然後再用一塊乾布擦拭。
(骯髒的門封很容易損壞並且可能會導致冷空氣洩露。)

當手指印和汗跡不易清除時，首先用輕輕浸泡過廚房中性洗滌液的布擦拭，然後再用濕布擦拭。最後再用乾布擦拭乾淨。
門由玻璃製成。不要撞擊其表面和端面。(可能會導致裂紋。)

冷藏室門的旋轉支點部位已經塗抹了潤滑油脂。不要擦掉！

→ 如果你要擦拭它，請諮詢經銷商。



立即擦洗！
如果有液體滴到雪櫃門邊緣，請立刻用乾布稍微用力將其擦去。

注意事項

- 使勁擰乾濕布。(如果水進入縫隙，可能會導致電氣部件故障。)
- 不要使用洗碗機 / 烘乾機來清洗塑料部件，例如儲水器 and 可清洗的製冰盒。(可能會導致部件變形。)
- 請勿使用以下物品清潔。



鹼性或弱鹼性

廚房洗滌劑 (中性洗滌劑除外)、
玻璃洗滌劑 (含氯漂白劑)
(它們會破解塑膠。)



清洗器、
拋光海綿



清潔劑、
肥皂粉



汽油、稀釋劑、
酒精、酸和石油



熱水

Moisture Control Filter

當污垢已成為問題

Moisture Control Filter 透過卡爪固定到 Moisture Control Plate 上。

請將其取出並用清水沖洗乾淨。(Moisture Control Plate 不可拆卸。)

沖洗乾淨後，徹底將水份瀝乾。擦去水滴並重新安裝。

對於頑固污漬，請用稀釋的廚房用清潔劑 (中性) 和軟毛牙刷輕柔刷洗，再用清水將清潔劑沖洗乾淨。

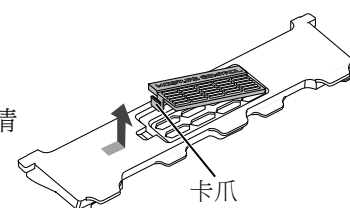

卡爪

注意事項

- 切勿使用漂白水或摩擦清洗。(這可能會削弱過濾器的性能。)

置物架 / 滑動置物架 (玻璃製成)

三個月一次

■ 置物架 (冷藏室內的上部擱架)

從置物架後面的突起部分脫鉤並拉動它。

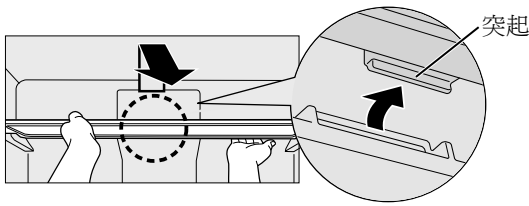

■ 置物架 (冷藏室上部的第二個擱架)

向上托起置物架後部朝前拉。
置物架托起脫離軌後，將置物架傾斜著取出。

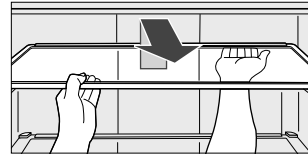

■ 滑動置物架

抬起前半部分並向內滑動，然後堆疊並抬起兩個擱架。

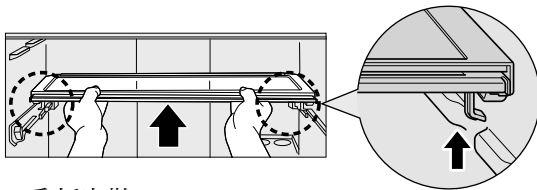

< 重新安裝 >

降低前半部分並沿著軌向後滑動。

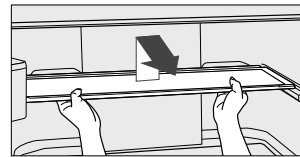

< 重新安裝 >

將兩個擱架放置在後面，然後拉動前半部分並向內滑動。

注意事項

- 隔架不可移動。進行清潔時，使用軟布擦拭而無需將其取下。
- 置物架、滑動置物架和隔架由玻璃製成，重量較重。請小心輕放以避免它們掉落，造成任何損害或傷害。
- 當門無法完全打開且很難取下滑動置物架時，向內滑動前半部分。

儲存盒 (微凍結 / 冰溫選擇室)

三個月一次

■ 取出

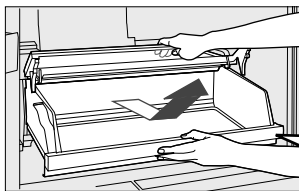

快速拉出儲存盒，抬起前端，然後握住儲存盒的上邊緣傾斜拉出。

鋁板可拆下。

■ 重新安裝

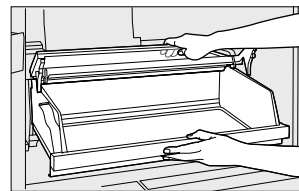

舉起擋板，升高儲存盒的背部，然後沿著內裡的滑軌安裝。

注意事項

- 在移走儲存盒前，請先將置瓶架取出。(否則，置瓶架可能會損壞。)
- 在拆下鋁板時請首先取出儲存盒子。如果用水清洗鋁板，請在排乾水並擦乾上面剩餘的水滴後重新裝上。
- 儲存盒和邊緣右端和左端之間的接觸部分已塗抹潤滑油。不要將其刷掉。→ 如果您已刷掉潤滑劑，請諮詢經銷商。

門架 / 置瓶架

三個月一次

■ 取出

向上輕敲門架底部，或者向上交替滑動置瓶架的左側和右側，慢慢將它們抬起。(門架和置瓶架安裝得很緊。)



■ 重新安裝

依據右側標誌 [>PS<]，平行安裝每個支架並向下推至適當的位置。

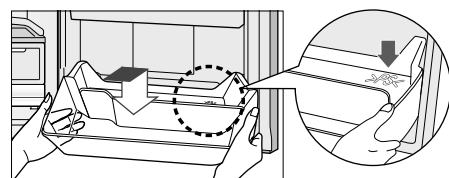

儲水器 / 淨水過濾器

一週一次

- ① 取下蓋子並用水清洗儲水器。
- ② 旋轉淨水過濾器以使其脫鉤取出。
- ③ 在水中輕輕清洗淨水過濾器。
- ④ 取下後面邊緣運行的填充物。用水清洗。
- ⑤ 安裝淨水過濾器並填充。

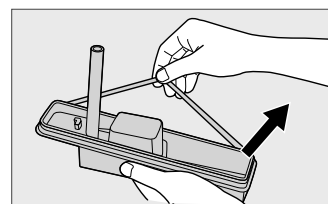
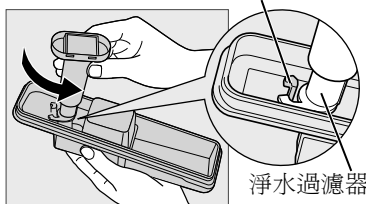
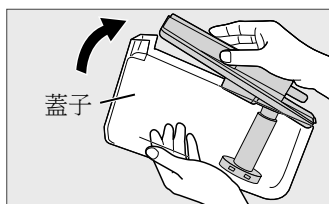

- 建議每三年更換一次淨水過濾器。(另售零件：第 79 頁)
- 如果在淨水過濾器上有水垢，可能無法正確製冰。

可清洗製冰盒 (製冰室內部)

一年一次或兩次

■ 移出製冰盒並沖洗。

- ① 按下 ，然後按下 **AUTO ICE OFF** 並停止製冰。
(**AUTO ICE OFF** 開啟。第 67 頁)
- ② 將製冰室中的旋鈕轉動至解鎖位置。
- ③ 向前拉拉桿以取出製冰盒。
- ④ 用水清洗。不要用海綿等擦拭表面。
(如果製冰盒被劃花，冰可能無法正確釋放，進而導致故障。)

- 製冰盒及其框架不能拆分。
- 不得使用洗碗烘乾機。

■ 重新安裝

- ① 推入直到發出咔噠聲。
- ② 將旋鈕轉動至鎖定位置。
如果製冰盒未鎖定，機器不會製冰。
- ③ 按下 ，然後按下 **AUTO ICE OFF** 並重新開始製冰。
(**AUTO ICE OFF** 關閉。第 67 頁)
- 直至 [AUTO ICE OFF] 取消，冰才可製取。
- 在清洗後不要直接將水放入製冰盒。
(否則，會引起冰塊粘接或故障。)

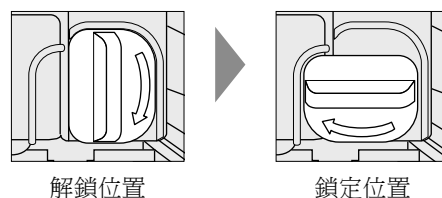
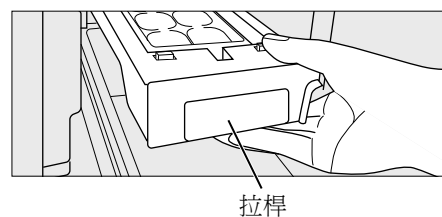
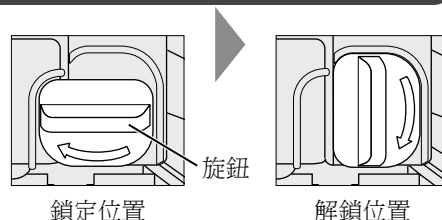

抽屜 (製冰室 / 新鮮凍結室 / 急凍室 / 蔬果室)

三個月一次

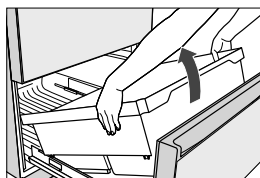

拉出一個傾斜角
迅速拉出門並抬起前端拉出一個傾斜角。

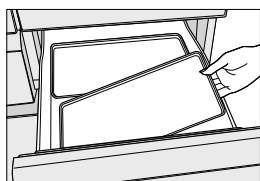

取出鋁板

須知事項

- 抽屜導軌的接觸部位塗有潤滑劑。不要擦掉！
→ 如果你將其刷掉，請諮詢你的經銷商。
- 卸除急凍室的上層板或小型蔬果盒時，請將層板底面所標示的“手前 FRONT”字樣朝向前方，進行安裝。
- 請勿用濕手觸摸鋁板，例如在清潔板時。
(這可能會引致凍傷手。)
- 清洗抽屜和鋁板時，要在排乾水並擦拭殘留水滴後方可安裝。

依據自己偏好設置

更詳細地調整溫度

■ 冷藏室和急凍室的溫度有設定更詳細，有 9 個檔位，如 “1”，“2” 和 “3”。
（當詳細調整溫度時 ECONAVI 將不會運作。）

冷藏室

設置步驟

- ① 按下 兩次並將冷藏室溫度設定到設置 “1”。
- ② 按下並按住 **FRIDGE** 至少 10 秒鐘。
（有嘟嘟聲，**2** 亮起，10 秒鐘後 **1**（第 1 檔）亮起。）
- ③ 按 **FRIDGE** 並選擇你選擇的檔位。
（每按一下 **FRIDGE**，檔位元就會變高。
如果當設置為第 9 檔（**3** 亮起）時，按 **FRIDGE**，設置回到 “1”（**1** 亮起）。

取消步驟

- ① 按下 兩次並將冷藏室溫度設定到設置 “1”。
- ② 按下並按住 **FRIDGE** 至少 10 秒鐘。
（有嘟嘟聲，然後 **1** 亮起，**2** 閃爍。）
- ③ 詳細的溫度設定取消已完成。
依據通常使用設定溫度。

設定	檔位	顯示器
“3”	9	3
	8	2 3
	7	2 3
“2”	6	2 3
	5	2
	4	1 2
“1”	3	1 2
	2	1 2
	1	1

顯示器狀態

2 開啟 **2** 閃爍

即使溫度設定為 “2”，
ECONAVI 也不工作。

急凍室

在上述①~③步驟基礎上按 **FREEZER** 而不是 **FRIDGE** 執行操作。

- 微凍結／冰溫選擇室的溫度不可進行詳細調節。
- 在通知顯示區沒有顯示時設定。

關閉 ECONAVI 燈號

■ 在 ECONAVI 運作模式期間，ECONAVI 燈號不會亮著。（第 61 頁）
（在通知顯示區沒有顯示時設定，急凍室和冷藏室設置為 “2”。）

設置步驟

按下 兩次，然後按下並
按住 **FRIDGE** 至少 3 秒鐘。



出現嘟嘟聲，ECONAVI 燈號閃爍。
設定完成。
（在一小段時間後，ECONAVI 燈號熄滅。）

- 即使在設定上述設置時，ECONAVI 運作模式仍運行。

取消步驟

按下 兩次，然後按下並
按住 **FRIDGE** 至少 3 秒鐘。





有嘟嘟聲，然後 ECONAVI 亮 3 秒鐘，完成取消
設置。
（在一小段時間後，ECONAVI 燈號熄滅。然而，
在 ECONAVI 運作模式期間，指示燈仍然亮起。）

調校 nanoe™ X 燈號的亮度

nanoe™ X 燈號的亮度可以調校。(第 61 頁)
(你只能在 PRIME FRESH 的溫度設置顯示器沒有閃爍時才能進行調校。)

設置步驟

按下  兩次，然後按下並
按住  至少 10 秒鐘。



蜂鳴聲發出。按下  以選擇您所需的亮度。
約 10 秒後，設置完成。

設置	1	2	3
亮度	熄滅	陰暗	光亮

(購買時的設置是“3”。)

- 以上設置不會影響 nanoe™ X 的效果。
- 如要取消，按上述操作並設置為“3”(光亮)。

鎖定操作面板上的操作

你可以鎖定操作面板，以便設置不會因為意外操作或兒童操作而改變。

設置步驟

按下並按住  至少 3 秒鐘。



有嘟嘟聲，“CL”出現在通知顯示器中，設置完成。
(短時間過後，“CL”在通知顯示器中消失。)

- 當鎖定功能被激活並且按下按鍵時，“CL”出現在通知顯示器中。
- 如需解鎖，進行上述相同操作。

故障排除

如果雪櫃不能正常工作，請首先檢查以下幾點。

如果故障仍然存在，請斷開電源插頭，並與經銷商或授權服務中心聯繫。

以下聲音是正常的。

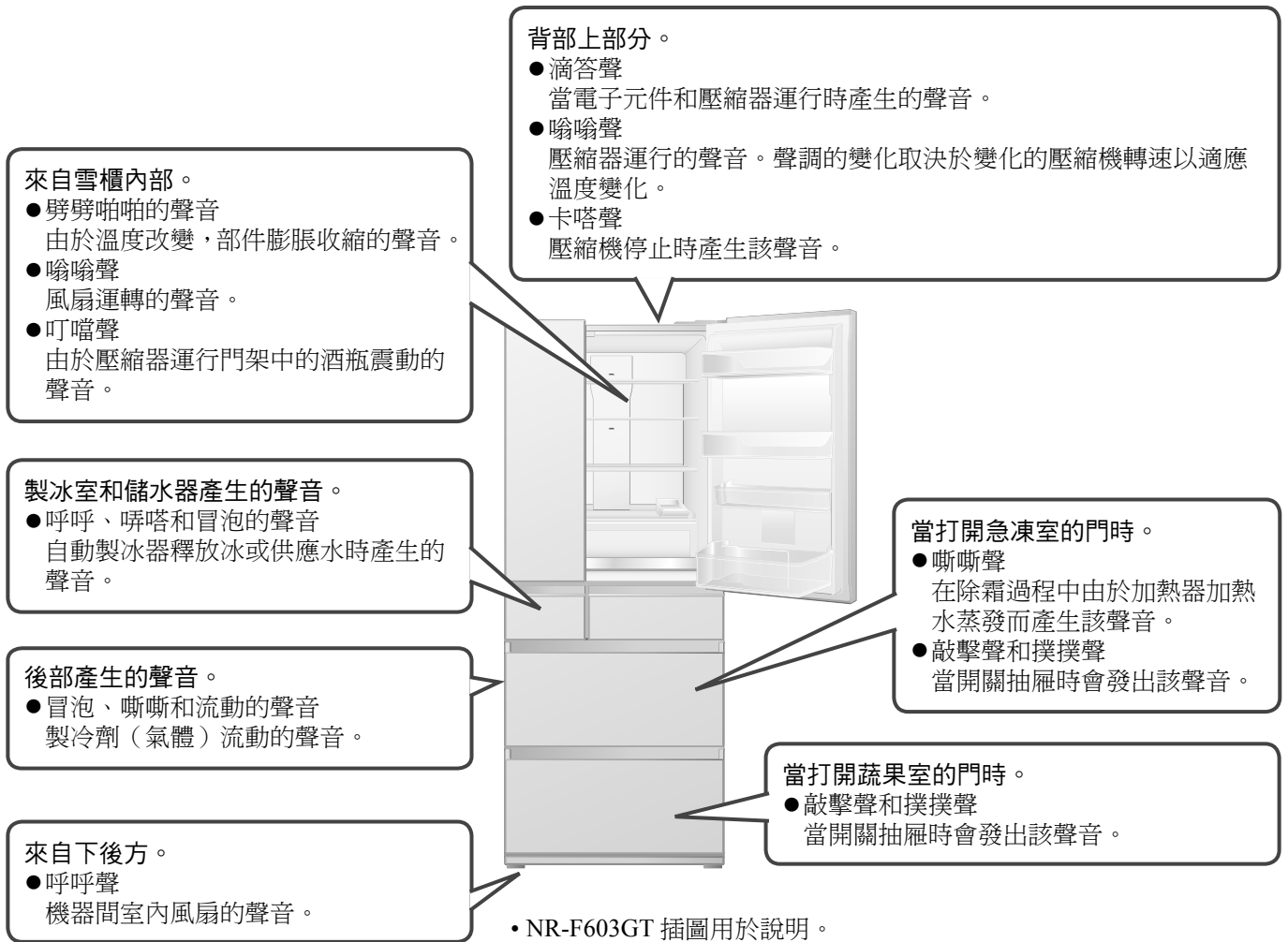

聲音	卡嗒聲	<ul style="list-style-type: none"> ● 將雪櫃放置在堅實平坦的地板上，使兩個可調校的雪櫃腳接觸地板，並固定雪櫃。(第 58 頁) ● 雪櫃側面或背面，或者電源線是否碰到牆壁或雪櫃周圍的家具？ → 放置雪櫃，使其不碰到周圍的物品。
	噪音困擾。	<ul style="list-style-type: none"> ● 當雪櫃進行冷卻時，壓縮器或風機可能發出大的噪音，比如雪櫃剛安裝，還沒有冷卻過；頻繁開關雪櫃門；雪櫃周圍的溫度過高或新鮮冷凍設置為開啟狀態。這是正常現象。 → 雪櫃冷卻後，噪音變小。
	敲擊聲	<ul style="list-style-type: none"> ● 當地板不平或使勁關門時，雪櫃顫動並產生噪音。 → 在雪櫃下方放置一塊板以防止其顫動。(第 58 頁)
	噪音持續。	<ul style="list-style-type: none"> ● 這是由於壓縮機轉速透過變頻器控制來調校。 (噪音可能不會停止，但這不是異常現象。)
雪櫃主體	雪櫃頂部發熱。	<ul style="list-style-type: none"> ● 機械部件釋放熱量。(第 59 頁)
	上部(或側)墊板發熱。	<ul style="list-style-type: none"> ● 製冷系統運行時左右墊板表面可能會發熱釋放產生的熱量。安裝後或夏天，溫度可能變為 50°C 至 60°C (當環境溫度為 30°C)。
	側面看起來彎曲。	<ul style="list-style-type: none"> ● 在製造過程中，可能會出現彎曲或表面波度，但這不是異常現象。
顯示	操作面板上的溫度設定在閃爍。	<ul style="list-style-type: none"> ● 冷藏室或急凍室的溫度已經進行細緻地調整了嗎？(第 72 頁) → 詳細設定溫度時，顯示器閃爍。取消該設置。(第 72 頁)
門	關閉後立即打開，門很重。	<ul style="list-style-type: none"> ● 進入雪櫃內的空氣急劇冷卻。內部壓力瞬間低於外部氣壓。門似乎朝裡面拉。
	磁鐵不會粘到門上。	<ul style="list-style-type: none"> ● 門是玻璃的。磁鐵不沾。
製冰	不能製冰。	<ul style="list-style-type: none"> ● 當首次使用該雪櫃時，要等到內部充分冷卻後方可製冰。 (可能需要 24 個小時或更長時間。) ● 確保未設定 [AUTO ICE OFF]。(第 67 頁) ● 將儲水器盡可能地往裡推入。推入製冰盒直到聽到卡嗒聲。(第 67 頁) ● 確保製冰盒已鎖定。(第 71 頁) ● 不要將食物等物品放入儲冰盒。(第 66 頁) ● 僅在需要時才拿取製冰盒。 ● 要確認製冰機是否工作，按下並按住 [AUTO ICE OFF] 至少 10 秒鐘。如果儲水器中的水減少，則製冰機正在工作。 ● 如果水溢入儲冰盒中，將水擦掉。 ● 如果水沒有減少，則製冰機沒有工作。 → 咨詢你的經銷商。
	冰塊內部沒有凍結。	<ul style="list-style-type: none"> ● 急凍室的溫控設置為“1”了嗎？ → 將其設置為“2”或“3”。(第 60 頁)
	冰的形狀不是“立方體”。	<ul style="list-style-type: none"> ● 有突出物。 → 製冰盒溝槽可能凍結。 ● 冰塊是圓形或與其他冰塊相粘接。 → 冰儲存很長時間了嗎？ (冰塊成圓形或粘接在一起。) ● 冰塊小。 → 當儲水器中沒有水時，有時會形成小冰塊。

氣味	冰塊有異味。	<ul style="list-style-type: none"> ● 每週清洗一次儲水器和淨水過濾器。(第 71 頁) ● 不要使用清潔劑或漂白劑來清洗儲水器和淨水過濾器。 ● 每 3 年更換一次淨水過濾器。(另售零件：第 79 頁)
	雪櫃室內有氣味。	<ul style="list-style-type: none"> ● 將氣味強烈的食物儲存在密封容器中。 ● 異味通常附著在內壁。 → 使用浸泡在溫水中的軟布擦拭冰箱壁。
冷卻	根本不變冷。	<ul style="list-style-type: none"> ● 如果 dd 顯示在操作面板的通知顯示器區域中，則取消演示模式。(第 78 頁) ● 確保沒有斷電，電源線連接到插座或斷路器沒有斷路。
	不足夠冷。	<ul style="list-style-type: none"> ● 當首次使用雪櫃時，雪櫃需要用 4 至 24 小時或更長的時間（夏季等）才開始製冷。 ● 將溫度設置更改為更低溫的設置。(第 60 頁) ● 確保食物沒有堵住冷風出口。(第 54 頁) ● 不要將雪櫃放置在陽光直射的地方。(第 58 頁) ● 確保雪櫃周圍有足夠的空間。(第 58 頁) ● 如果食物塞得過多或長時間使用“Fresh Freezing”，雪櫃可能需要更長的時間才會冷卻。
	霜露	<ul style="list-style-type: none"> ● 當濕度較高時，不要長時間開門或頻繁打開門。 ● 當在商店購買的配件（例如管架）卡在門里時，將其拆下。 ● 如果食物從急凍室容器或蔬果室盒的後面掉出時，則門沒有正確關閉。取出食物。 ● 當濕度較高時，可能會在雪櫃外表面形成霜露。 → 用一塊乾布擦拭。
	食物凍結。	<ul style="list-style-type: none"> ● 將溫度設置設定為“2”（或“1”）。(第 60 頁) ● 環境溫度為 5°C 攝氏度或以下？ → 將溫度設置設定為“1”。(第 60 頁) ● 不要將水分含量高的食物放在雪櫃冷風口（第 54 頁）或微凍結室 / 冰溫選擇室附近。
微凍結	微凍結快速模式即將停止，或在運行到一半時停止。	<ul style="list-style-type: none"> ● 在以下情形中，快速模式的時間可能會縮短（在短時間內從快速模式返回到正常的微凍結操作）。 <ul style="list-style-type: none"> • 在快速模式完成之後。 • 當雪櫃根據食物量或溫度判斷不需要快速模式時。 • 在除霜期間。 • 當冷藏室或急凍室溫度較高時。 ● 根據使用條件，快速模式能會停止，並在隔室溫度穩定後重新啟動。

在這些情況下？

<p>電源出現故障。</p>	<ul style="list-style-type: none"> ● 保持門關閉，並且不要再存儲其他食品。 ● 停止 [FRESH FREEZING] 和 [QUICK ICE MAKING] 功能。再次設定這些功能以在電力恢復後使用。
<p>斷開電源插頭。</p>	<ul style="list-style-type: none"> ● 至少要等待 7 分鐘，方可插入電源插頭。 (如果立即插入電源插頭，壓縮器會超載引起故障。)
<p>長時間不用雪櫃。</p>	<ul style="list-style-type: none"> ● 取出所有食品和飲料，清洗雪櫃。 <ol style="list-style-type: none"> ① 拔掉電源插頭。 ② 清洗食品儲藏室和製冰盒。(第 69 頁～ 71 頁) ③ 保持雪櫃門開至兩至三天，晾乾食品儲藏室。 (食品儲藏室潮濕，可能發黴或出現臭味。)
<p>雪櫃燈明燈不亮。</p>	<p>→ 諮詢你的經銷商 (當雪櫃燈閃爍時，參見第 78 頁。)</p>
<p>玻璃破碎。 (玻璃置物架・門)</p>	<ul style="list-style-type: none"> ● 當玻璃置物架和玻璃門破碎時，不要觸碰破碎的玻璃。 → 立即諮詢你的經銷商。
<p>移動雪櫃。</p>	<ul style="list-style-type: none"> ● 如需防止地板表面受損，請放置保護板等。 <ol style="list-style-type: none"> ① 拔掉電源插頭。 ② 取下腳蓋，然後調高可調校的雪櫃腳。(第 58 頁) ③ 向前或向後移動雪櫃。 ④ 移動之後，使用可調校的雪櫃腳固定雪櫃。重新連接腳蓋。(第 58 頁)
<p>移動或搬運雪櫃時。</p>	<ul style="list-style-type: none"> ● 應至少兩人來搬運雪櫃。請勿橫向搬運雪櫃。(可能會導致人身傷害或雪櫃故障。) ① 取出食品和飲料並排出儲水器中的水。 ② 停止自動製冰功能。(第 67 頁) ③ 清洗製冰盒。(第 71 頁) ④ 拔掉電源插頭。 ⑤ 取下可調校的雪櫃腳的腳蓋螺絲。(第 58 頁) (在搬運雪櫃前應取下腳蓋。) ⑥ 在排水孔下面放置一個容器 (其高度不超過 2 cm)。 ⑦ 向後傾斜雪櫃以使水從排水孔中排出。(為防止水洩漏，應緩慢向後傾斜雪櫃。) ⑧ 防止保護板或類似的物品並移動雪櫃。 (由於水可能仍然留在裡面。) <div data-bbox="1187 1021 1481 1357" style="text-align: right;">  <p>排水口 (後面底部)</p> </div> <div data-bbox="1294 1364 1485 1422" style="text-align: right;"> <p>放置容器和抹布。 (水可能會溢出。)</p> </div> <div data-bbox="501 1384 673 1435" style="border: 1px solid black; border-radius: 15px; padding: 5px; display: inline-block;"> <p>注意事項</p> </div> <ul style="list-style-type: none"> ● 如果雪櫃內的冷卻設備上有霜 (從外面看不到)，移動雪櫃時水可能會濺出。 (在斷開雪櫃電源插座後，冷卻設備上的霜大約需要 15 個小時才融化。)
<p>自動製冰器長時間不使用。</p>	<ul style="list-style-type: none"> ● 停止製冰、清空儲水器並清潔製冰機。 <ol style="list-style-type: none"> ① 倒掉儲水器中的水。 ② 按下 ，然後按下  並停止製冰。(第 67 頁) ( 開啟。) ③ 倒掉製冰盒和儲冰盒中儲存的冰。 <ul style="list-style-type: none"> ● 當冰儲存時間久的話，冰塊會變圓或會粘接。 ④ 沖洗儲冰盒、冰鏟和儲水器。 擦乾水並將它們放回原位。 <ul style="list-style-type: none"> ● 徹底乾燥淨水過濾器。(淨水過濾器含有水分。如果沒有徹底乾燥，可能會導致霉菌或異味。) <p>→ 當再次開始使用自動製冰機時，取消 “AUTO ICE OFF”。(第 67 頁)</p> <div data-bbox="1289 1581 1481 1704" style="text-align: right;">  </div> <div data-bbox="1289 1727 1481 1850" style="text-align: right;">  </div>

如果出現以下聲音或現象

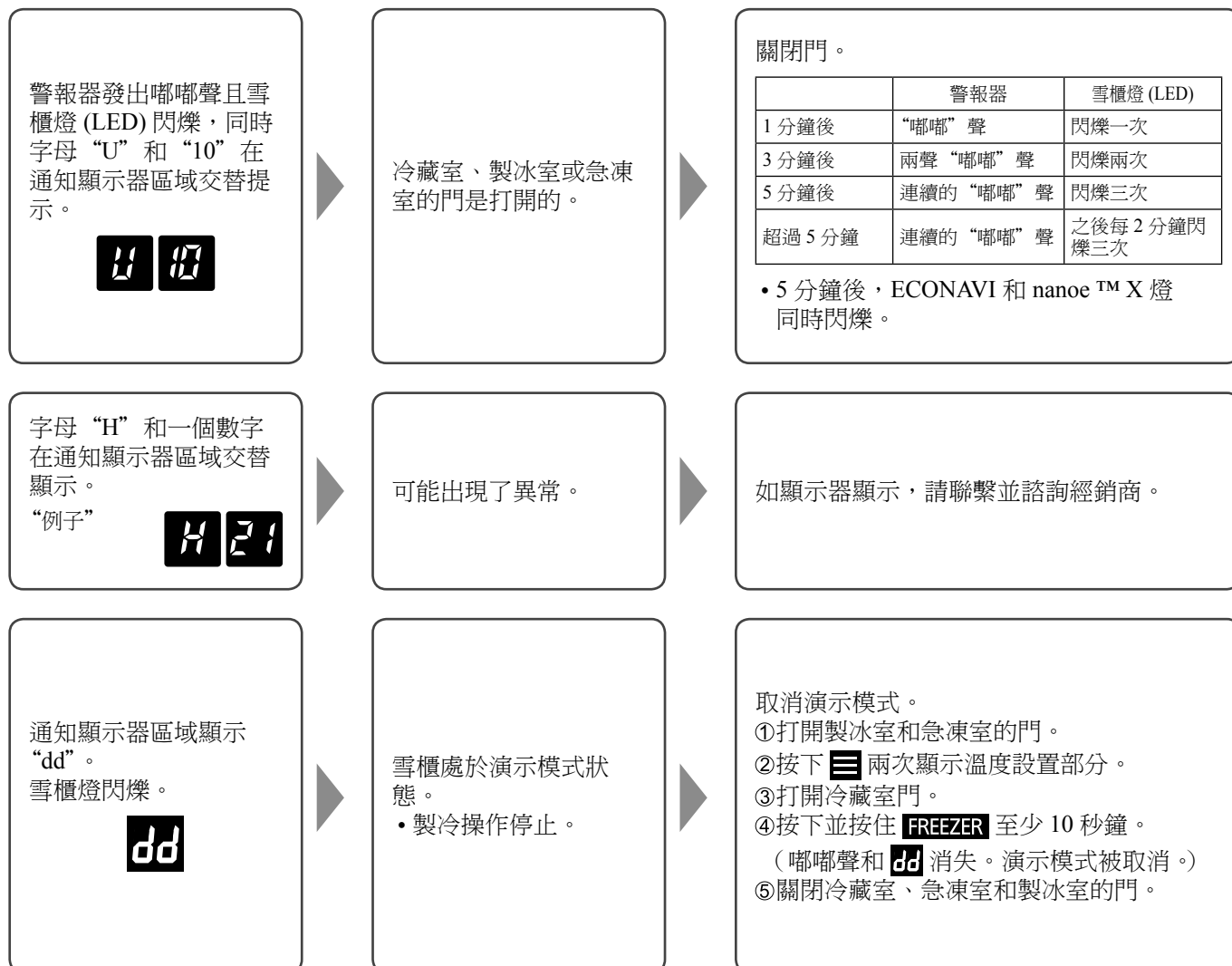

規格

型號	NR-F654GT-X6 NR-F654HX-X3	NR-F603GT-X6 NR-F603GT-W6 NR-F603GT-N6 NR-F603HX-X3 NR-F603HX-W3 NR-F603HX-N3	NR-F603GT-XP	NR-F603GT-XU NR-F603GT-WU	NR-F503GT-X6 NR-F503GT-W6 NR-F503GT-T6 NR-F503GT-T7 NR-F503HX-X3 NR-F503HX-W3 NR-F503HX-N3
總容量	684 L	628 L	589 L	628 L	528 L
總淨容量	534L	488 L	488 L	492L	402 L
冷藏室淨容量	327 L	301 L	301 L	304 L	250 L
製冰室淨容量	8 L	5 L	5 L	5 L	4 L
新鮮凍結室淨容量	18 L	18 L	18 L	18 L	14 L
急凍室淨容量	85 L	77 L	77 L	78 L	63 L
蔬果室淨容量	96 L	87 L	87 L	87 L	71 L
外型尺寸 寬 × 深 × 高	750 mm × 745 mm × 1828 mm	685 mm × 745 mm × 1828 mm			650 mm × 699 mm × 1828 mm
重量	123 kg / 271 lb	114 kg / 251 lb			105 kg / 231 lb
額定電壓 額定頻率	冷藏室門內側的品質指示標籤標定。				

- NR-F603GT-XP、NR-F603GT-XU 和 NR-F603GT-WU 以外的其他型號容量基於 IEC 62552。
- NR-F603GT-XP 的容量基於 ISO 8561。
- NR-F603GT-XU 和 NR-F603GT-WU 的容量基於 AS/NZS 4474。

另售零件

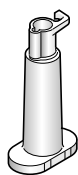

儲水器用淨水過濾器 (第 71 頁)
ARMH00B00820

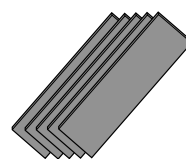

板調節墊板 (第 58 頁)
CNR79-338120

Panasonic Corporation

Web site: <http://www.panasonic.com>

© Panasonic Corporation 2019



M0419-0
ARAH0A100000
Printed in Japan