

5. Dimensions

5.1 Indoor Unit

5.1.1 CS-RZ9BKA CS-RZ12BKA

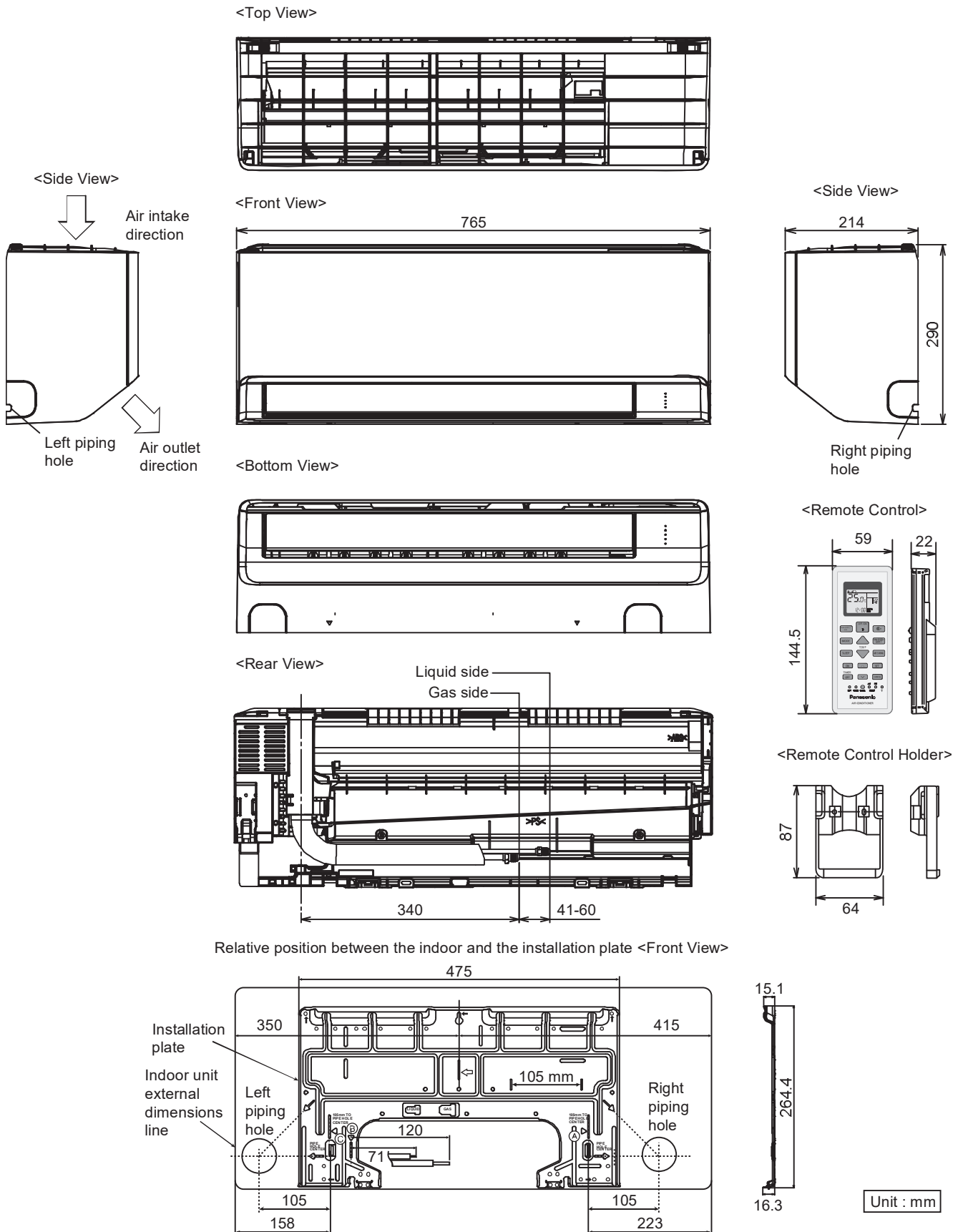

5.1.2 CS-RZ18BKA CS-RZ24BKA

<Top View>

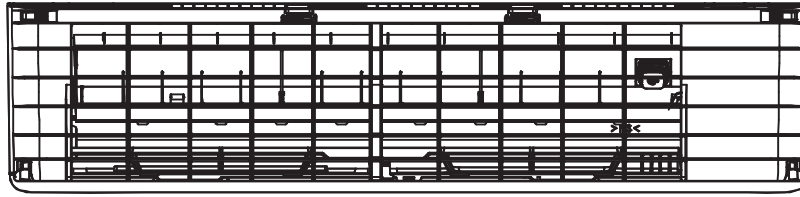

<Side View>

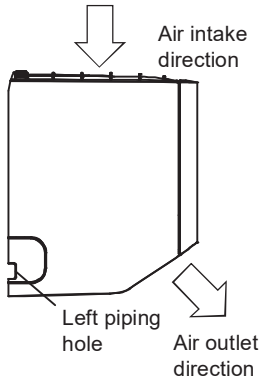

<Front View>

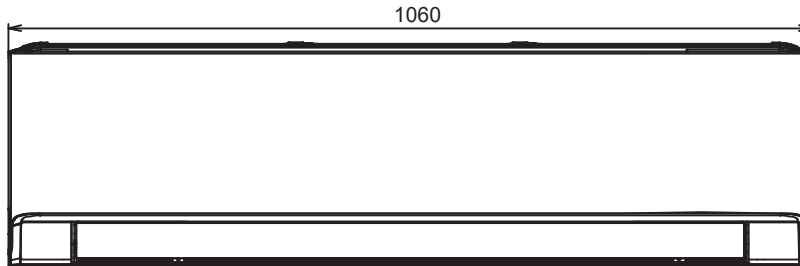

<Side View>

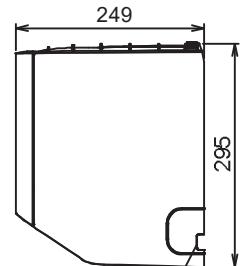

<Bottom View>

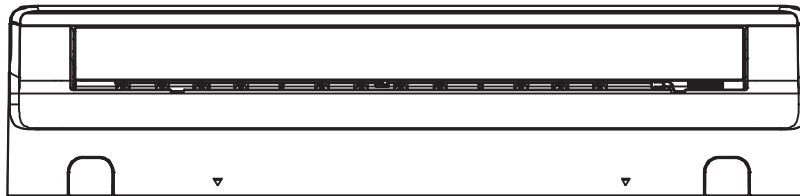

<Remote Control>

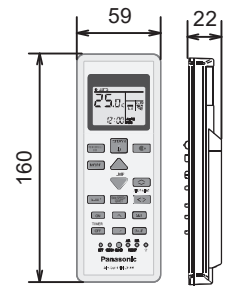

<Rear View>

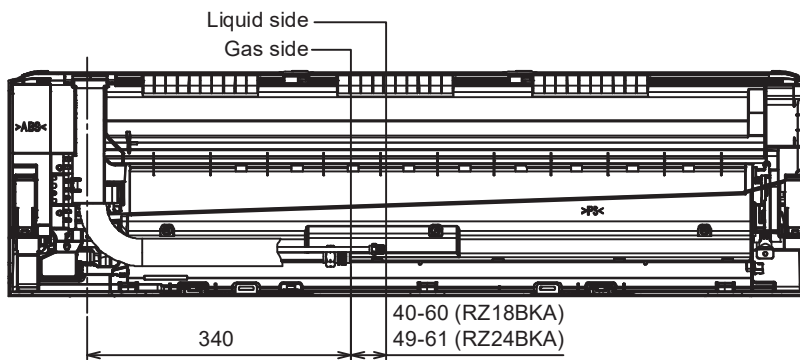

<Remote Control Holder>

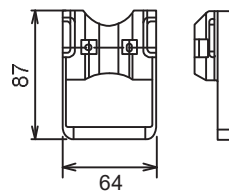

Relative position between the indoor and the installation plate <Front View>

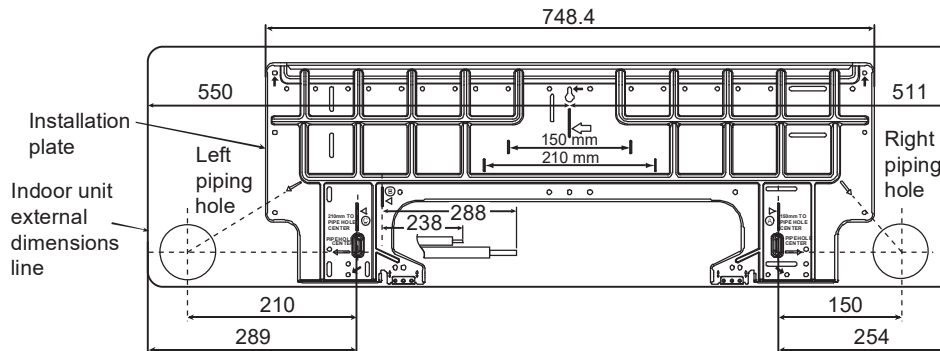

Unit : mm

5.2 Outdoor Unit

5.2.1 CU-RZ9BKA CU-RZ12BKA

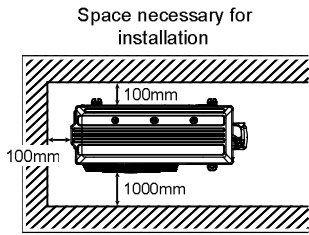

Anchor Bolt Pitch
320 × 570

<Side View>

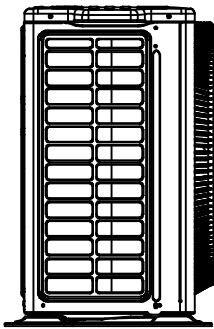

Unit : mm

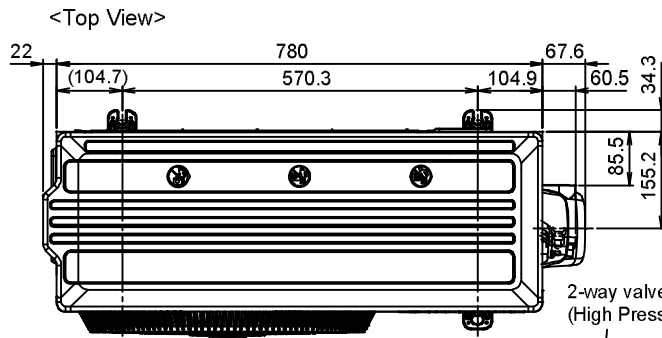

2-way valve at Liquid side
(High Pressure)

<Front View>

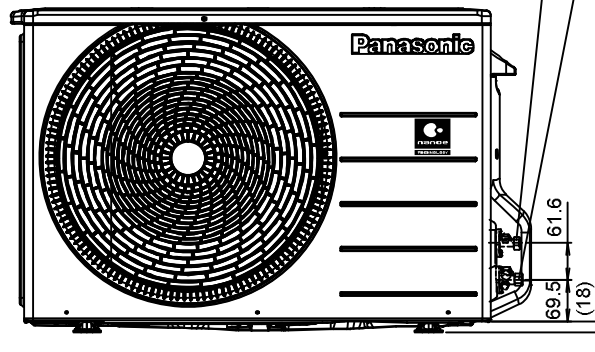

3-way valve at Gas side
(Low Pressure)

<Side View>

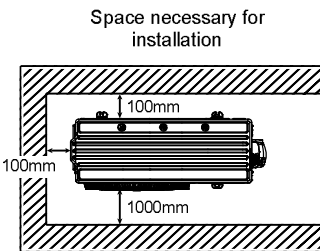
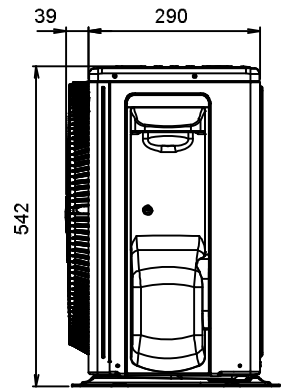

Anchor Bolt Pitch
330 × 540

<Side View>

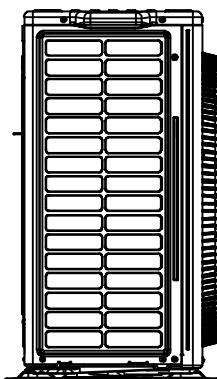

Unit : mm

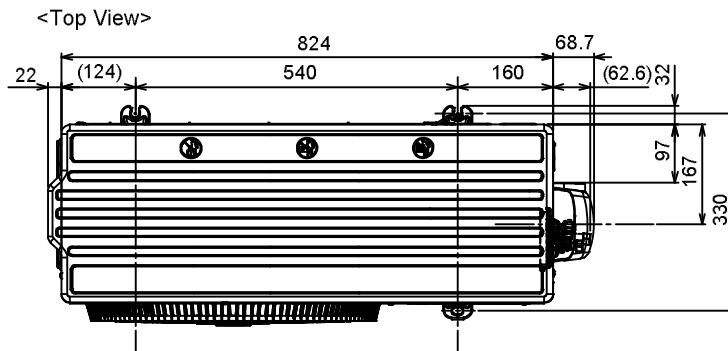

2-way valve at Liquid side
(High Pressure)

3-way valve at Gas side
(Low Pressure)

<Front View>

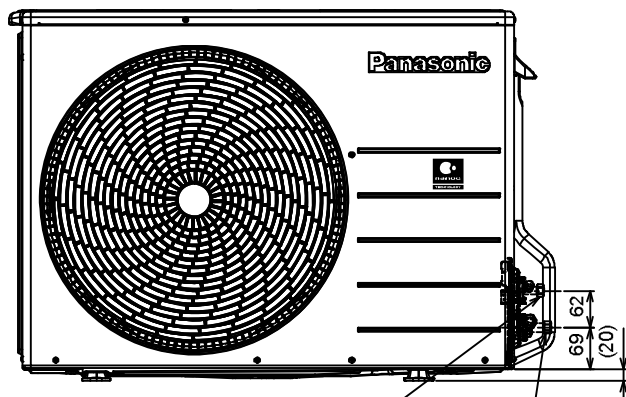

<Side View>

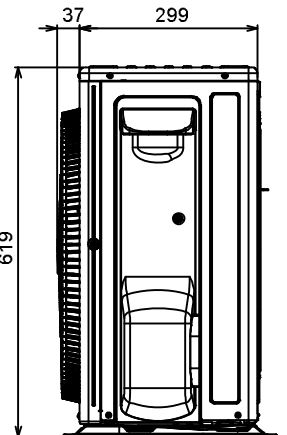

5.2.3 CU-RZ24BKA

