

5. Dimensions

5.1 Indoor Unit and Remote Control

5.1.1 CS-LZ9ZKA CS-LZ12ZKA

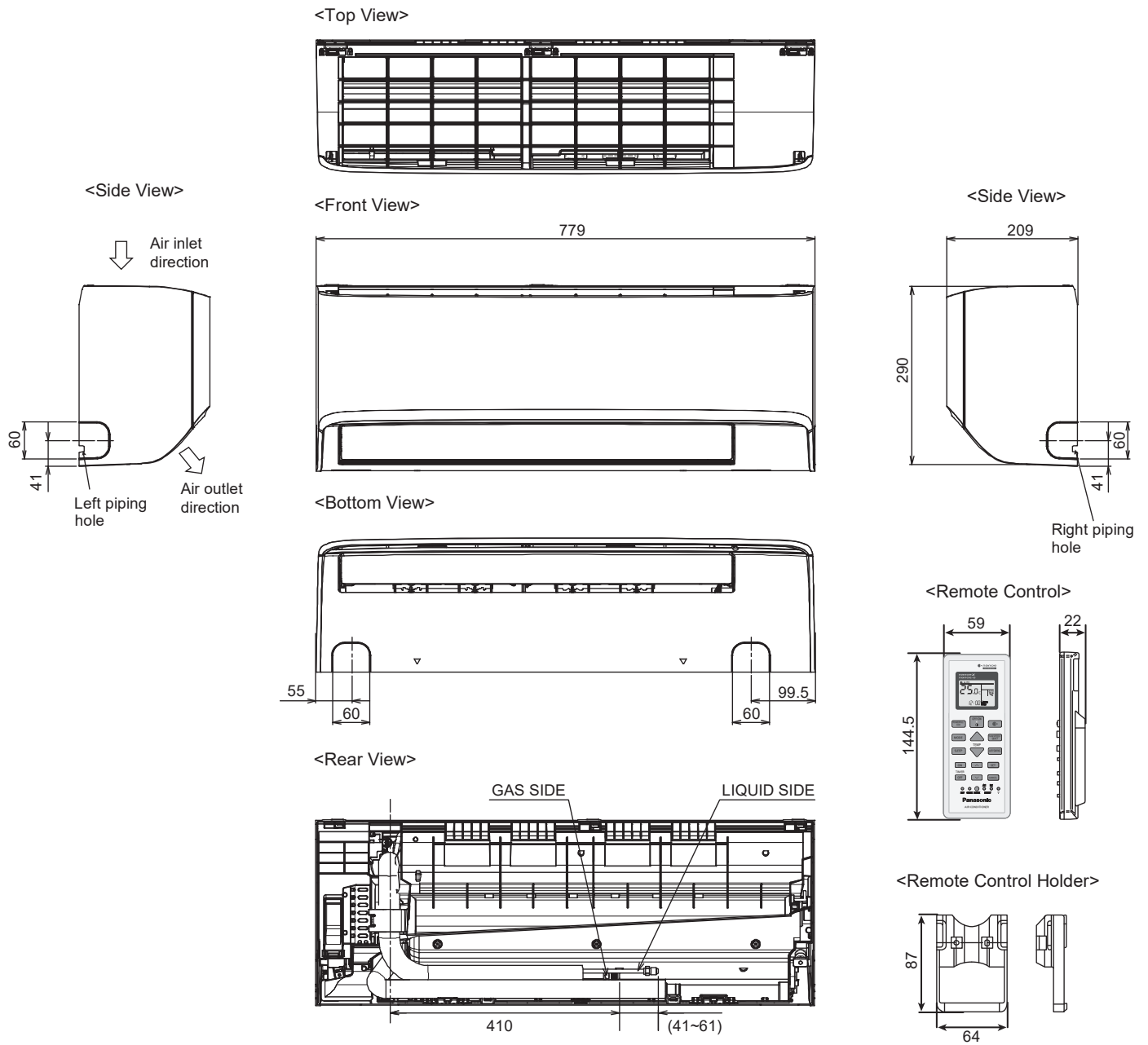

Relative position between the indoor unit and the installation plate <Front View>

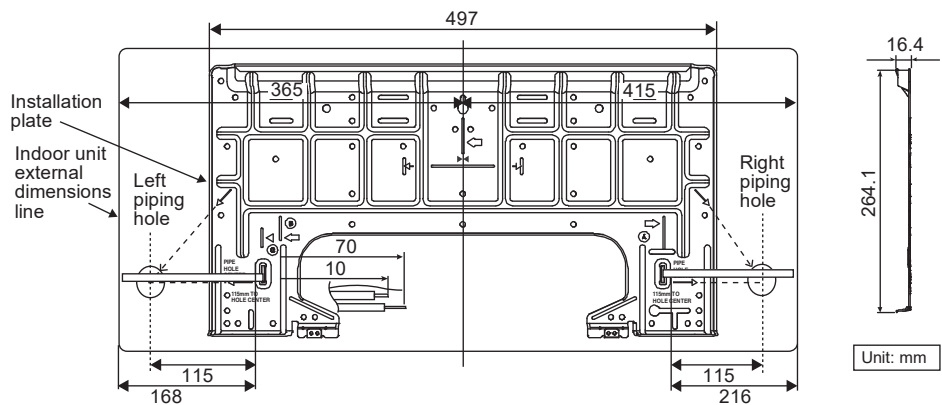

5.1.2 CS-LZ18ZKA

<Top View>

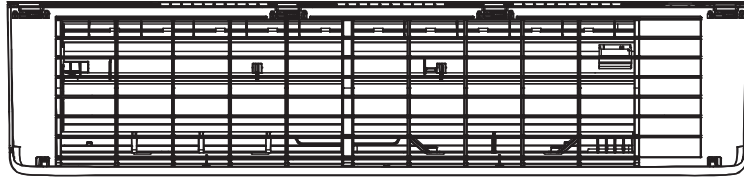

<Side View>

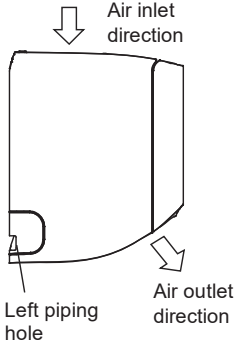

<Front View>

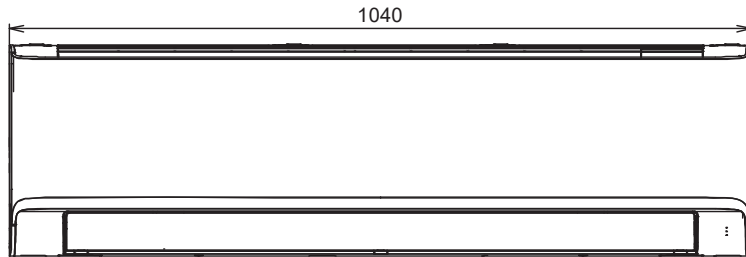

<Side View>

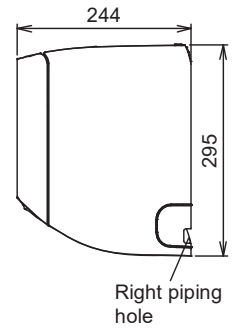

<Bottom View>

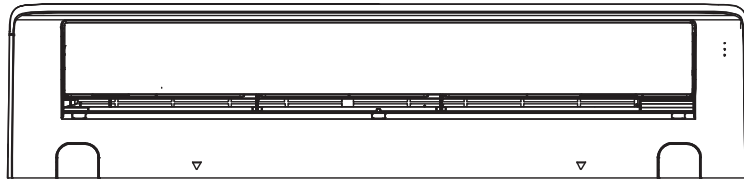

<Remote Control>

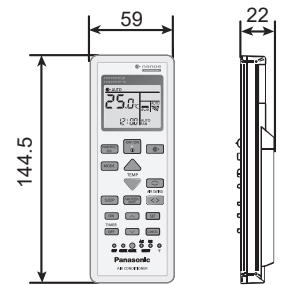

<Rear View>

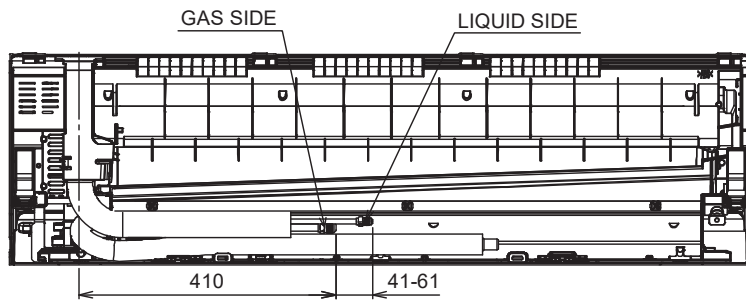

<Remote Control Holder>

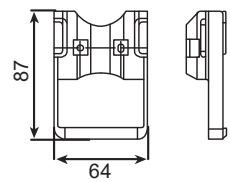

Relative position between the indoor unit and the installation plate <Front View>

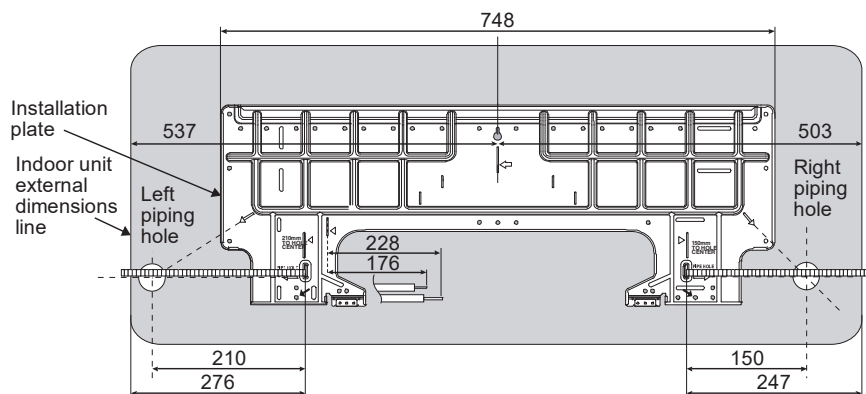

Unit: mm

5.2 Outdoor Unit

